



DeKalb County Department of Planning & Sustainability

330 Ponce De Leon Avenue, Suite 500

Decatur, GA 30030

(404) 371-2155 / plandev@dekalbcountyga.gov

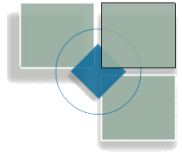

Michael Thurmond
Chief Executive Officer

Planning Commission Hearing Date: March 4, 2021

Board of Commissioners Hearing Date: March 25, 2021

STAFF ANALYSIS

Case No.: Z-21-1244531 **Agenda #:** N13

Location/Address: The east side of Northern Avenue, and the northern terminus of Creekview Drive, approximately 140 feet south of Indian Creek Way, at 671, 657, 635, 655, 649, 641, 631, and 623 Northern Avenue, Clarkston, Georgia. **Commission District:** 4 **Super District:** 6

Parcel ID: 18-045-08-001, 18-045-08-003, 18-045-08-004, 18-045-08-005, 18-045-08-006, 18-045-08-007, 18-045-08-008, 18-045-08-095

Request: To rezone properties from R-75 (Residential-Medium Lot-75) and MR-2 (Medium Density Residential-2) District to RSM (Small Lot Residential Mix) District to construct townhomes and single-family detached residences.

Property Owner: Fugees Land Holdings, LLC, Anjali Grandhige, & Hemanth Grandhige

Applicant/Agent: Inline Communities LLC c/o Battle Law

Acreage: 22

Existing Land Use: Vacant land and Single-Family homes

Surrounding Properties: A single-family detached subdivision (Cloudland Subdivision) to the south; multi-family apartments (Navarro Apartments) to the north; a stream buffer/floodplain and townhomes to the east (Ridgeland Creek Townhomes); and single-family homes and multi-family apartments (Tuscany Village Apartments) to the west and southwest across Northern Avenue.

Adjacent Zoning: **North:** MR-2 **South:** R-75 **East:** MR-2 **West:** R-75 & MR-2

Comprehensive Plan: SUB (Suburban) **Consistent** **Inconsistent**

Proposed Density: 6.68 units per acre **Existing Density:** NA
Proposed Units/Square Ft.: 147 residential units comprising single-family attached townhomes and single-family detached homes. **Existing Units/Square Feet:** Vacant Land and Single-Family Homes
Proposed Lot Coverage: NA **Existing Lot Coverage:** NA

Staff Recommendation: FULL CYCLE DEFERRAL

ZONING HISTORY

In 2010, the Board of Commissioners approved to modify the conditions of the R-75 and MR-2 zoning (Case CZ-10-16332) and also approved a Special Land Use Permit (SLUP) (Case Number SLUP 10 16333) to allow a private, 120-student capacity middle school, soccer fields, a faculty residence, and a community garden on the subject properties.

PROJECT ANALYSIS

The subject property comprises 22 acres on the east side of Northern Avenue, approximately 140 feet south of Indian Creek Way, at 671, 657, 635, 655, 649, 641, 631, and 623 Northern Avenue, Clarkston. The site contains vacant land and single-family structures. The site slopes steeply downward from the north to the south. The site currently has an abundance of mature trees and vegetation. There is a stream and floodplain area on the eastern portion of the site that appears to be 120 feet wide.

The submitted revised site plan show 147 residential units at a density of 6.68 units per acre comprising 45 single-family detached homes (comprising urban single family and conventional single-family lots) and 102 single-family attached townhomes. The RSM district allows a base density of four units per acre, with densities up to 8 units per acre if density bonuses are provided. To achieve a density of 6.84 units per acre, the applicant is providing density bonuses consisting of public art and additional enhanced open space (20% open space is required for the entire site, and to get the density bonus all of that 20% open space must be enhanced open space such as dog parks, pocket parks, pool amenities, etc). The site plan indicates that the applicant is providing more open space than required (20% required at 4.43 acres, 32% provided at 7.09 acres), and that 20% of the open space is enhanced open space. However, the enhanced open space on the eastern edge of the site has not been clarified as to what type of enhanced open space is being provided.

Based on the submitted information, the plan's *conceptual* layout of providing single-family detached lots along the south and west perimeter of the site abutting single-family detached homes and providing townhomes along the north and east portions of the site abutting multi-family apartments and townhomes appears to be an appropriate transition of land uses. The proposed density of 6.84 units per acre is an appropriate transition between the density of the single-family detached homes to the south at two units per acre and the density of the multi-family apartments and townhomes to the north and east at 19 units per acre and 10 units per acre, respectively. The proposed three story building heights of the proposed townhomes are consistent with the two and three story building heights of the multi-family apartments to the north and the single-family attached townhomes to the east. The proposed two-story building heights of the single-family detached lots along the southern portion of the site, along with the 20-foot wide planted buffer should provide additional compatibility with the adjacent single-family detached subdivision to the south. Those proposed single-family detached lots also comply with the perimeter compatibility requirements of the zoning ordinance since those 64 foot-wide lots are 80% as wide as the abutting single-family lots to the south.

While the site plan is *conceptually* appropriate, there are several details that need to be provided and/or clarified to ensure that the plan is conforming to RSM zoning standards and is compatible with surrounding properties as follows:

1. The zoning ordinance requires a minimum lot width of 25 feet for single-family attached townhomes in the RSM zoning district, but the submitted plan shows minimum lot widths of 20 and 24 feet for the proposed single-family attached townhomes. Additionally, RSM zoning requires townhomes to have a minimum lot area of 1,000 square feet, and some of the proposed townhomes appear to only have 900 square feet of lot area. The plan needs to

be revised to reflect compliance.

2. The site plan is showing compliance with the minimum amount of required *enhanced* open space to qualify for the density bonus. However, the zoning ordinance requires that the type of enhanced open space be indicated (i.e. dog park, pocket park, pool amenity area, trail, etc). The type of enhanced open space on the eastern edge of the site near the floodplain needs to be clarified to ensure compliance with this requirement.
3. The proposed building heights of the single-family detached lots along the southern portion of the site needs to be clarified. Maximum building height in RSM zoning is 35 feet, so a maximum of two stories would be consistent with the one and two-story single-family homes to the south.
4. Planning Department would ideally like to have the plan revised to have the open space distributed more evenly by providing some open space near each of the two access entrances on Northern Avenue, and by providing some open space in the middle of the proposed single-family detached lots along the southern end of the site to break up the long monotonous row of two-car garages that will be seen as one drives down that drive. Planning Department would also like to have the plans address what trees are being preserved to save as much of the existing tree canopy as possible, and would like to see if any trees are being saved in the proposed 20-ft transitional buffer along the southern property line abutting a single-family neighborhood.

Surrounding uses include a single-family detached subdivision (Cloudland Subdivision) to the south; multi-family apartments (Navarro Apartments) to the north; a stream buffer, floodplain, and townhomes to the east (Ridgeland Creek Drive townhomes), and single-family homes and multi-family apartments (Tuscany Village Apartments) to the west and southwest across Northern Avenue.

Supplemental Requirements: There are no supplemental regulations in the zoning ordinance for single-family detached or attached homes.

Compliance with District Standards:

STANDARD	RSM REQUIREMENT	EXISTING/PROPOSED	COMPLIANCE
MAX DENSITY	4-8 units per acre	6.68 units per acre with enhanced open space and public art density bonus.	Undetermined. The site plan needs to clarify what type of enhanced open space (i.e dog park, pocket park, trail, etc) is being provided along the eastern portion of the site to verify compliance with enhanced open space density bonus.

LOT WIDTH	50 feet per single-family detached lot (minimum)	64 feet	Yes
	25 feet per single-family attached lot	20 feet and 24 feet	No. Non-compliance will necessitate variances
	25 feet per urban single-family lot	38 feet	Yes
LOT AREA	5,000 s.f. (minimum for s.f. detached lot)	6,400 s.f.	Yes
	1,350 s.f. (minimum for urban single-family detached)	3,420 s.f.	Yes
	1000 s.f. (minimum for s.f. attached lot)	900 s.f. & 1,200 s.f.	Yes No. Non-compliance will necessitate variances.
MAX. LOT COVERAGE	50% for single-family detached	Information not provided	Undetermined
	70% for single-family attached & urban single-family	Information not provided	Undetermined
FRONT SETBACK	20 feet	20 feet	Yes
REAR SETBACK	20 ft.	20 ft	Yes
SIDE SETBACK	3 ft from p/l with min. 10 feet between buildings for single-family detached conventional	3 feet from p/l with min. 10 feet between buildings	Yes
	0 ft from p/l with 3 feet between buildings for urban single-family detached lots	0 ft from p/l with 3 feet between buildings for urban single-family detached	Yes
	None for single-family attached.	0 feet from p/l	Yes

BUILDING MATERIALS	All building facades shall consist of at least 80% brick, stone, glass, decorative concrete, fiber cement siding, or hard coat stucco, or combination thereof.	Conceptual elevations appear to comply.	Yes
MAX. BLDG. HEIGHT	35 feet for single-family detached conventional lots 45 feet or three stories, whichever is less for single-family attached and urban single-family	Information not provided 3 stories of 45 feet	Undetermined. Non-compliance shall necessitate variances. Yes
MIN UNIT SIZE	1,200 s.f. for single-family detached or attached 1,100 s.f. for urban single-family detached	1,200 s.f. 1,100 s.f.	Yes Yes
MIN OPEN SPACE MIN ENHANCED OPEN SPACE TO QUALIFY FOR DENSITY BONUS	20% 20%	32% 20%	Yes Need clarification on type of enhanced open space along eastern edge of site
TRANSITIONAL BUFFER	None required when abutting an MR zoning district or when single-family lots abut adjacent single-family subdivision	None required. However the proposed plan is providing a 20-ft wide transitional buffer along the southern property line which abuts an adjacent single-family subdivision.	Yes

<p>PARKING</p>	<p>Min of 284 spaces</p> <p>90 spaces for single-family detached (2 spaces per dwelling unit).</p> <p>179 spaces for single-family attached (1.5 spaces per dwelling unit plus .25 spaces per unit for guest parking)</p> <p>15 spaces for pool amenity (1 space per 10 homes)</p> <p>Max of 542 spaces</p> <p>180 spaces for single-family detached (4 spaces per dwelling unit)</p> <p>332 Three (3) spaces per dwelling unit, plus one-quarter (0.25) space per dwelling unit to accommodate guest parking</p> <p>30 spaces for pool amenity (1 space per 5 homes)</p>	<p>510 spaces</p>	<p>Yes.</p>
<p>LANDSCAPING</p>	<p>Each single-family lot on which new development shall occur shall be planted with three new trees.</p>	<p>Information not provided on site plan.</p>	<p>Non-compliance will necessitate variances.</p>
<p>SIDEWALKS AND STREETSCAPING</p>	<p>6-ft. sidewalk along Northern Avenue, 10-ft. landscape strip, street trees 50 ft. on center</p> <p>5-ft sidewalk and 5-ft landscape strip along private drives with street trees 50 ft on center.</p>	<p>10 ft multi-use path, landscape strips and street trees not shown on plan.</p> <p>Not shown on plan</p>	<p>Undetermined. Non-compliance will necessitate variances.</p> <p>Undetermined. Non-compliance will necessitate variances.</p>

STREET LIGHTS AND PEDESTRIAN LIGHTS	Street lights shall be installed along public right of way within the landscape strip spaced at a maximum distance of 80 ft on center. Pedestrian lights shall be installed along public right of way at a maximum distance of 40 ft on center.	Information not provided	Undetermined. Non-compliance will necessitate a variance.
INTERNAL SIDEWALKS	Pedestrian access shall be provided from all parking areas directly to a public sidewalk.	Internal sidewalks not shown on plan	Undetermined. Non-compliance will necessitate variances.

LAND USE AND ZONING ANALYSIS

Section 27-7.3.5 of the Zoning Ordinance, “Standards and factors governing review of proposed amendments to the official zoning map” states that the following standards and factors shall govern the review of all proposed amendments to the zoning maps.

A. Whether the zoning proposal is in conformity with the policy and intent of the comprehensive plan:

Based on the information and site plan, it cannot be determined if the proposed rezoning request is consistent with the policies and strategies of the Suburban Character Area to protect stable neighborhoods from incompatible development (Suburban Policy #1). The submitted plan’s *conceptual* layout of single-family detached lots along the south and west perimeter of the site abutting single-family detached homes and providing townhomes along the north and east portions of the site abutting multi-family apartments and townhomes appears to be an appropriate transition of land uses. The proposed density of 6.84 units per acre is an appropriate transition between the density of the single-family detached homes to the south at two units per acre and the density of the multi-family apartments and townhomes to the north and east at 19 units per acre and 10 units per acre, respectively. Additionally, the plan appears to be providing more open space than is required by the zoning ordinance (35% provided, 20% required), and is also providing a 20-foot transitional buffer between the proposed single-family detached lots and the abutting single-family neighborhood to the south to further enhance compatibility with surrounding uses. However, there are several details that need to be provided and/or clarified to ensure that the plan is conforming to RSM zoning standards and is compatible with the single-family neighborhood to the south along Sandy Woods Lane.

B. Whether the zoning proposal will permit a use that is suitable in view of the use and development of adjacent and nearby properties:

Based on the information from the applicant, it cannot be determined if the zoning proposal will permit a use

that is suitable in view of the single-family detached lots to the south. The submitted plan's *conceptual* layout of single-family detached lots along the south and west perimeter of the site abutting single-family detached homes and providing townhomes along the north and east portions of the site abutting multi-family apartments and townhomes appears to be an appropriate transition of land uses. The proposed density of 6.84 units per acre is an appropriate transition between the density of the single-family detached homes to the south at two units per acre and the density of the multi-family apartments and townhomes to the north and east at 19 units per acre and 10 units per acre, respectively. Additionally, the plan appears to be providing more open space than is required by the zoning ordinance (35% provided, 20% required), and is also providing a 20-foot transitional buffer between the proposed single-family detached lots and the abutting single-family neighborhood to the south to further enhance compatibility with surrounding uses. However, there are several details that need to be provided and/or clarified to ensure that the plan is conforming to RSM zoning standards and is compatible with the single-family neighborhood to the south along Sandy Woods Lane.

C. Whether the property to be affected by the zoning proposal has a reasonable economic use as currently zoned:

It appears that the property may have a reasonable economic use as currently zoned R-75 and MR-2 which allows single-family attached and detached residential development.

D. Whether the zoning proposal will adversely affect the existing use or usability of adjacent or nearby property:

Based on the submitted information, it cannot be determined if the zoning proposal will adversely affect the existing usability of adjacent or nearby property. See response to Section 7.3.5.A & 7.3.5.B above.

E. Whether there are other existing or changing conditions affecting the use and development of the property, which give supporting grounds for either approval or disapproval of the zoning proposal:

There are several details that need to be provided and/or clarified to ensure that the plan is conforming to RSM zoning standards and is compatible with the single-family neighborhood to the south along Sandy Woods Lane.

F. Whether the zoning proposal will adversely affect historic buildings, sites, districts, or archaeological resources:

Based on the submitted information, no historic buildings, sites, districts, or archaeological resources are located on the subject property or in the surrounding area.

G. Whether the zoning proposal will result in a use which will or could cause an excessive or burdensome use of existing streets, transportation facilities, utilities, or schools: — —

There has been no indication from reviewing departments and agencies that the proposal could cause excessive use of utilities. Regarding school impacts, enrollment at Clarkston High School is already above capacity and students from new development may cause additional strain. The new replacement Indian Creek Elementary School will be opening Fall 2021, providing additional capacity for elementary students or schools (see attached School comments). The DeKalb County Transportation Department has provided comments to address any potential traffic impacts (see attached), including a requirement that all access points must meet minimum intersection and stopping sight distance requirements per AASHTO Greenbook for the posted speed limit and

presented (signed and sealed by a professional engineer) with the land development permit documents. The applicant will need to obtain a sewer capacity letter from the Department of Watershed Management to verify if sewer capacity is available.

H. Whether the zoning proposal adversely impacts the environment or surrounding natural resources:

The proposed development is not expected to have unusual impacts on the natural environment.

Planning and Sustainability Department Recommendation: FULL CYCLE DEFERRAL

Based on the submitted information, the plan's *conceptual* layout of providing single-family detached lots along the south and west perimeter of the site (abutting single-family detached homes) and providing townhomes along the north and east portions of the site (abutting multi-family apartments and townhomes) appears to be an appropriate transition of land uses. The proposed density of 6.68 units per acre is an appropriate transition between the density of the single-family detached homes to the south at two units per acre and the density of the multi-family apartments and townhomes to the north and east at 19 units per acre and 10 units per acre, respectively. The three story building heights of the proposed townhomes are consistent with the two and three story building heights of the multi-family apartments to the north and the single-family attached townhomes to the east. The proposed single-family detached lots along the southern property line comply with the perimeter compatibility requirements of the zoning ordinance since those 64 foot-wide lots are 80% as wide as the abutting single-family lots to the south. Furthermore, the 20-foot wide planted buffer should provide additional compatibility with those adjacent single-family detached homes to the south.

While the site plan is *conceptually* appropriate, there are several details that need to be provided and/or clarified to ensure that the plan is conforming to RSM zoning standards and is compatible with surrounding properties as follows:

1. The zoning ordinance requires a minimum lot width of 25 feet for single-family attached townhomes in the RSM zoning district, but the submitted plan shows minimum lot widths of 20 and 24 feet for the proposed single-family attached townhomes. Additionally, RSM zoning requires townhomes to have a minimum lot area of 1,000 square feet, and some of the proposed townhomes appear to only have 900 square feet of lot area. The plan needs to be revised to reflect compliance. The plan needs to be revised to reflect compliance.
2. The site plan is showing compliance with the minimum amount of required *enhanced* open space to qualify for the density bonus. However, the zoning ordinance requires that the type of enhanced open space be indicated (i.e. dog park, pocket park, pool amenity area, trail, etc). The type of enhanced open space on the eastern edge of the site near the floodplain needs to be clarified to ensure compliance with the enhanced open space density bonus requirement.
3. The proposed building heights of the single-family detached lots along the southern portion of the site needs to be clarified. Maximum building height in RSM zoning is 35 feet, so a maximum of two stories would be consistent with the one and two-story single-family homes to the south.
4. Planning Department would ideally like to have the plan revised to have the open space distributed more evenly by providing some open space near each of the two access entrances on Northern Avenue, and by providing some open space in the middle of the proposed single-family detached lots along the southern end of the site to break up the long monotonous row of two-car garages that will be seen as one drives down that drive. Planning Department would also like to have the plans address what trees are being preserved to save as much of the existing tree canopy as possible, and would like to see if any trees are being saved in the proposed 20-ft transitional buffer along the southern property line.

The applicant has requested that this case be deferred for a full cycle to allow an opportunity to address these issues (see attached deferral letter dated February 24, 2021). Therefore, it is the recommendation of the Planning and

Sustainability Department that the rezoning application be “deferred, full cycle” to allow the opportunity for the applicant to address these issues.

Attachments:

1. Public Works Department Comments
 - a. Land Development Division
 - b. Traffic Engineering Division
2. Watershed Management Department Comments
3. Board of Health Comments
4. Board of Education Comments
5. Application
6. Site Plan
7. Zoning Map
8. Aerial Photograph
9. Photographs



MICHELE L. BATTLE, ESQ.
President

February 24, 2021

VIA E-MAIL

John Reid, Senior Planner
DeKalb County Planning and Sustainability
330 W. Ponce De Leon Ave., 3rd F1.
Decatur, GA 30030

Re: Z-21-1244531 for 671, 657, 635, 655, 649, 641, 631, 623 Northern Ave Clarkston, Ga 30021

Dear John:

On behalf of my client, Inline Communities, we respectfully request a full cycle deferral to better address traffic concerns and design elements raised by staff. Please feel free to contact me if you have any questions regarding this deferral request.

Sincerely,

Michèle L. Battle



DEKALB COUNTY GOVERNMENT PLANNING DEPARTMENT DISTRIBUTION FORM

The following areas below may warrant comments from the Development Division. Please respond accordingly as the issues relate to the proposed request and the site plan enclosed as it relates to Chapter 14. You may address applicable disciplines.

DEVELOPMENT ANALYSIS:

- **Transportation/Access/Row**

Consult the Georgia DOT as well as the DeKalb County Transportation Department prior to land development permit. Verify widths from the centerline of the roadways to the property line for possible right-of-way dedication. Improvements within the right-of-way may be required as a condition for land development application review approval. Safe vehicular circulation is required. Paved off-street parking is required.

- **Storm Water Management**

Compliance with the Georgia Stormwater Management Manual, DeKalb County Code of Ordinances 14-40 for Stormwater Management and 14-42 for Storm Water Quality Control, to include Runoff Reduction Volume where applicable is required as a condition of land development permit approval. Use Volume Three of the G.S.M.M. for best maintenance practices. Use the NOAA Atlas 14 Point Precipitation Data set specific to the site. Recommend Low Impact Development features/ Green Infrastructure be included in the proposed site design to protect as much as practicable the statewaters and special flood hazard areas.

- **Flood Hazard Area/Wetlands**

The presence of FEMA Flood Hazard Area **was** indicated in the County G.I.S. mapping records for the site; and should be noted in the plans at the time of any land development permit application. Encroachment of flood hazard areas require compliance with Article IV of Chapter 14 and FEMA floodplain regulations.

- **Landscaping/Tree Preservation**

Landscaping and tree preservation plans for any building, or parking lot must comply with DeKalb County Code of Ordinances 14-39 as well as Chapter 27 Article 5 and are subject to approval from the County Arborist.

- **Tributary Buffer**

State water buffer **was** reflected in the G.I.S. records for the site. Typical state waters buffer have a 75' undisturbed stream buffer and land development within the undisturbed creek buffer is prohibited without a variance per DeKalb County Code of Ordinances 14-44.1.

- **Fire Safety**

Plans for land development permit must comply with Chapter 12 DeKalb County Code for fire protection and prevention.



DEKALB COUNTY GOVERNMENT PLANNING DEPARTMENT DISTRIBUTION FORM

NOTE: PLEASE RETURN ALL COMMENTS VIA EMAIL OR FAX TO EXPEDITE THE PROCESS TO MICHELLE M ALEXANDER mmalexander@dekalbcountyga.gov OR JOHN REID jreid@DEKALBCOUNTYGA.GOV

COMMENTS FORM: PUBLIC WORKS WATER AND SEWER

Case No.: Z-21-1244531

Parcel I.D. #: 18-045-08-001, 18-045-08-003, 18-045-08-004, 18-045-08-005, 18-045-08-006, 18-045-08-007, 18-045-08-008, 18-045-08-095

Address: 671, 657, 635, 655, 649, 641, 631, and 623 Northern Avenue

Clarkston, Georgia

WATER:

Size of existing water main: 6" AC Water Main (adequate/inadequate) ^{SD}

Distance from property to nearest main: Adjacent to Property

Size of line required, if inadequate: N/A

SEWER:

Outfall Servicing Project: Indian Creek Basin

Is sewer adjacent to property: Yes (X) No () If no, distance to nearest line: _____

Water Treatment Facility: Snapfinger WTF () adequate () inadequate

Sewage Capacity; * (MGPD)

Current Flow: 21.77 (MGPD)

COMMENTS:

* Please note that the sewer capacity has not been reviewed or approved for this project. A Sewer Capacity Request (SCR) must be completed and submitted for review. This can be a lengthy process and should be addressed early in the process.

Capacity Restricted Area SD

Signature: *[Handwritten Signature]*



N-13

DEKALB COUNTY GOVERNMENT
PLANNING DEPARTMENT
DISTRIBUTION FORM

NOTE: PLEASE RETURN ALL COMMENTS VIA EMAIL OR FAX TO EXPEDITE THE PROCESS TO
MICHELLE ALEXANDER MMALEXANDER@DEKALBCOUNTYGA.GOV OR JOHN REID
JREID@DEKALBCOUNTYGA.GOV

COMMENTS FORM:
PUBLIC WORKS TRAFFIC ENGINEERING

Case No.: Z-21-1244531 Parcel I.D. #: 18-045-08-001

Address: 67H
NORTHEAN AVE
CLARKSTON, GA 30021

Adjacent Roadway (s):

(classification) (classification)

Capacity (TPD) _____	Capacity (TPD) _____
Latest Count (TPD) _____	Latest Count (TPD) _____
Hourly Capacity (VPH) _____	Hourly Capacity (VPH) _____
Peak Hour. Volume (VPH) _____	Peak Hour. Volume (VPH) _____
Existing number of traffic lanes _____	Existing number of traffic lanes _____
Existing right of way width _____	Existing right of way width _____
Proposed number of traffic lanes _____	Proposed number of traffic lanes _____
Proposed right of way width _____	Proposed right of way width _____

Please provide additional information relating to the following statement.

According to studies conducted by the Institute of Traffic Engineers (ITE) 6/7TH Edition (whichever is applicable), churches generate an average of fifteen (15) vehicle trip end (VTE) per 1, 000 square feet of floor area, with an eight (8%) percent peak hour factor. Based on the above formula, the _____ square foot place of worship building would generate _____ vehicle trip ends, with approximately _____ peak hour vehicle trip ends.

Single Family residence, on the other hand, would generate ten (10) VTE's per day per dwelling unit, with a ten (10%) percent peak hour factor. Based on the above referenced formula, the _____ (Single Family Residential) District designation which allows a maximum of _____ units per acres, and the given fact that the project site is approximately _____ acres in land area, _____ daily vehicle trip end, and _____ peak hour vehicle trip end would be generated with residential development of the parcel.

COMMENTS:

Reviewed. Nothing found that would disrupt traffic flow.

Signature: David Wilson

N1. No Comment

N2 & N3. Coordinate and provide the required right of way for the GDOT Managed Lanes I-285 East Project prior to permitting. GDOT PM: Tim Matthews at TMatthews@dot.ga.gov. Rockbridge Road is classified as a minor arterial. Please note the infrastructure requirements in Chapter 5 of the Zoning Code and Chapter 14-190 of the Land Development Code. A right of way dedication of 40 from centerline or such that all public infrastructure (sidewalks/streetlights) are within right of way, whichever greater. Required: 10- foot landscape strip, 6-foot sidewalk, bike lanes, streetlights. All access points must meet minimum intersection and stopping sight distance requirements per AASHTO Greenbook for 35 mph and presented (signed and sealed by a professional engineer)with the land development permit documents.

N4 & N5. Covington Hwy is a state route. Review and approval by GDOT District 7 (Justin Hatch at Juhatch@dot.ga.gov) required prior to issuance land development permit. Covington Hwy is classified as a major arterial. Please note the infrastructure requirements in Chapter 5 of the Zoning Code and Chapter 14-190 of the Land Development Code. A right of way dedication of 50 from centerline or such that all public infrastructure (sidewalks/streetlights) are within right of way, whichever greater. Required at a minimum (GDOT may have additional requirements): 10- foot landscape strip, 6-foot sidewalk, bike lanes or multiuse path, streetlights. All access points must meet minimum intersection and stopping sight distance requirements per AASHTO Greenbook for the posted speed limit and presented (signed and sealed by a professional engineer)with the land development permit documents.

N6 & N7. Pine Mountain Road is classified as a local residential. Please note the infrastructure requirements in Chapter 5 of the Zoning Code and Chapter 14-190 of the Land Development Code. A right of way dedication of 27.5 feet from centerline or such that all public infrastructure (sidewalks/streetlights) are within right of way, whichever greater. Required: 6- foot landscape strip, 5-foot sidewalk, streetlights. All access points must meet minimum intersection and stopping sight distance requirements per AASHTO Greenbook for the posted speed limit and presented (signed and sealed by a professional engineer)with the land development permit documents.

Please note that we received complaints about truck traffic on this street and it is posted no trucks. Consideration should be given to how to handle truck access and traffic. Limit all truck access to SR 124 Turner Hill Road. No truck access on Pine Mountain Rd.

N8. No Comment

N9. This development requires a traffic study (337 units) be presented to identify required improvements prior to zoning. I recommend deferral until a traffic study is submitted so that we can incorporate the result of the traffic study into the zoning conditions. Traffic study should address requirements for left turning lanes and right turn lane on North Druid Hills at the Mount Moriah Road and the need for a potential traffic signal. Please confirm the existing right of way on Mount Moriah Road. The county records show a 60 foot right of way and it appears that the development is encroaching on the right of way. The study should also address the lanes needed to accommodate the traffic exiting Mount Moriah Rd at the intersection. Direct pedestrian access is to be provided from the public sidewalks to the proposed development. North Druid Hills Road is classified as a major arterial. Please note the infrastructure requirements in Chapter 5 of the Zoning Code and Chapter 14-190 of the Land Development Code. A right of way dedication of 50 from centerline or such that all public infrastructure

(sidewalks/streetlights) are within right of way, whichever greater. Required at a minimum: 10- foot landscape strip, 6-foot sidewalk, bike lanes or multiuse path, streetlights. All access points must meet minimum intersection and stopping sight distance requirements per AASHTO Greenbook for the posted speed limit and presented (signed and sealed by a professional engineer)with the land development permit documents. Mount Moriah Road is classified as a local road. Please note the infrastructure requirements in Chapter 5 of the Zoning Code and Chapter 14-190 of the Land Development Code. A right of way dedication of 27.5 feet from centerline or such that all public infrastructure (sidewalks/streetlights) are within right of way, whichever greater. Required at a minimum: 6- foot landscape strip, 5-foot sidewalk, streetlights. Mount Moriah Road must be brought up to minimum county standards to include at least 22 feet of pavement along entire property frontage. All access points must meet minimum intersection and stopping sight distance requirements per AASHTO Greenbook for the posted speed limit and presented (signed and sealed by a professional engineer)with the land development permit documents.

N10 & N11. Pine Mountain Road is classified as a local. Please note the infrastructure requirements in Chapter 5 of the Zoning Code and Chapter 14-190 of the Land Development Code. A right of way dedication of 27.5 feet from centerline or such that all public infrastructure (sidewalks/streetlights) are within right of way, whichever greater. Required: 6- foot landscape strip, 5-foot sidewalk, streetlights. All access points must meet minimum intersection and stopping sight distance requirements per AASHTO Greenbook for the posted speed limit and presented (signed and sealed by a professional engineer) with the land development permit documents.

N12. Requesting a traffic study be completed prior to zoning to determine the impacts of the development on the intersection of Rockbridge Road at Mountain Park Trail and the proposed driveway on Rockbridge Road. Only one access point of Mountain Park Trail. The access point on Mountain Park Trail must be shifted to the rear property line away from Rockbridge Road. Please note the minimum driveway/street separation required in Section 14-200 (6). Remove acceleration lane from Rockbridge Road frontage. Provide direct pedestrian access from public right of way to the proposed destinations. Rockbridge Road is classified as a minor arterial. Please note the infrastructure requirements in Chapter 5 of the Zoning Code and Chapter 14-190 of the Land Development Code. A right of way dedication of 40 from centerline or such that all public infrastructure (sidewalks/streetlights) are within right of way, whichever greater. Required: 10- foot landscape strip, 6-foot sidewalk, bike lanes, streetlights. Mountain Park Trail is classified as a local. Please note the infrastructure requirements in Chapter 5 of the Zoning Code and Chapter 14-190 of the Land Development Code. A right of way dedication of 27.5 feet from centerline or such that all public infrastructure (sidewalks/streetlights) are within right of way, whichever greater. Required: 6- foot landscape strip, 5-foot sidewalk, streetlights. All access points must meet minimum intersection and stopping sight distance requirements per AASHTO Greenbook for 35 mph and presented (signed and sealed by a professional engineer)with the land development permit documents.

N13. Northern Ave is classified as a collector road. Please note the infrastructure requirements in Chapter 5 of the Zoning Code and Chapter 14-190 of the Land Development Code. A right of way dedication of 35 from centerline or such that all public infrastructure (sidewalks/streetlights) are within right of way, whichever greater. Required: 10- foot landscape strip, 6-foot sidewalk, bike lanes or multiuse path, streetlights. . All access points must meet minimum intersection and stopping sight

distance requirements per AASHTO Greenbook for the posted speed limit and presented (signed and sealed by a professional engineer)with the land development permit documents.

N14. No comment.

N15, N16 and N17. Panola Road is classified as a major arterial. Please note the infrastructure requirements in Chapter 5 of the Zoning Code and Chapter 14-190 of the Land Development Code. A right of way dedication of 50 feet from centerline or such that all public infrastructure (sidewalks/streetlights) are within right of way, whichever greater. Required at a minimum: 10- foot landscape strip, 6-foot sidewalk, bike lanes or multiuse path, streetlights. All access points must meet minimum intersection and stopping sight distance requirements per AASHTO Greenbook for the posted speed limit and presented (signed and sealed by a professional engineer)with the land development permit documents. Young Road is classified as a collector road. Please note the infrastructure requirements in Chapter 5 of the Zoning Code and Chapter 14-190 of the Land Development Code. A right of way dedication of 35 feet from centerline or such that all public infrastructure (sidewalks/streetlights) are within right of way, whichever greater. Required: 10- foot landscape strip, 6-foot sidewalk, bike lanes, streetlights. All access points must meet minimum intersection and stopping sight distance requirements per AASHTO Greenbook for 35 mph and presented (signed and sealed by a professional engineer)with the land development permit documents. Please note the minimum driveway/street separation required in Section 14-200 (6). Applies to driveways on the opposite side of the road also. Access point on Young Road needs to be relocated away from the traffic signal. The developer is required to upgrade the pedestrian features of the traffic signal at Panola Road at Young Road, as needed, as identified by the Transportation Division of Public Works. A pedestrian connection must be provided from the public sidewalk to the building entrances.

N18. Clairmont Road is a state route. Review and approval by GDOT District 7 required prior to issuance land development permit. Clairmont Road is classified as a major arterial. Only one access point allowed on Clairmont Road located away from the intersection with N Williamsburg Dr. Please note the infrastructure requirements in Chapter 5 of the Zoning Code and Chapter 14-190 of the Land Development Code. A right of way dedication of 50 from centerline or such that all public infrastructure (sidewalks/streetlights) are within right of way, whichever greater. Required at a minimum (GDOT may have additional requirements): 10- foot landscape strip, 6-foot sidewalk, bike lanes or multiuse path, streetlights. All access points must meet minimum intersection and stopping sight distance requirements per AASHTO Greenbook for the posted speed limit and presented (signed and sealed by a professional engineer)with the land development permit documents. N. Williamsburg Drive is classified as a local road. Please note the infrastructure requirements in Chapter 5 of the Zoning Code and Chapter 14-190 of the Land Development Code. A right of way dedication of 27.5 feet from centerline or such that all public infrastructure (sidewalks/streetlights) are within right of way, whichever greater. Required at a minimum: 6- foot landscape strip, 5-foot sidewalk, streetlights. Only one access point allowed on N Williamsburg Road located away from the intersection on Clairmont Road. All access points must meet minimum intersection and stopping sight distance requirements per AASHTO Greenbook for the posted speed limit and presented (signed and sealed by a professional engineer) with the land development permit documents.

N19. No Comment

N20. Clifton Springs Road is classified as a minor arterial. Please note the infrastructure requirements in Chapter 5 of the Zoning Code and Chapter 14-190 of the Land Development Code. A right of way dedication of 40 feet from centerline or such that all public infrastructure (sidewalks/streetlights) are within right of way, whichever greater. Required at a minimum: 10-foot landscape strip, 6-foot sidewalk, bike lanes or multiuse path, streetlights. All access points must meet minimum intersection and stopping sight distance requirements per AASHTO Greenbook for the posted speed limit and presented (signed and sealed by a professional engineer) with the land development permit documents. If interior roads are to public. They will need to meet the requirements for a local road. Please note the infrastructure requirements in Chapter 5 of the Zoning Code and Chapter 14-190 of the Land Development Code. A right of way dedication of 27.5 feet from centerline or such that all public infrastructure (sidewalks/streetlights) are within right of way, whichever greater. Required: 6-foot landscape strip, 5-foot sidewalk, streetlights. All access points must meet minimum intersection and stopping sight distance requirements per AASHTO Greenbook for the posted speed limit and presented (signed and sealed by a professional engineer) with the land development permit documents.

**Board of Health**

02/15/2021

To: Mr. John Reid, Senior Planner
From: Ryan Cira, Environmental Health Manager
Cc: Alan Gaines, Technical Services Manager
Re: Rezone Application Review

General Comments:

DeKalb County Health Regulations prohibit use of on-site sewage disposal systems for:

- multiple dwellings
- food service establishments
- hotels and motels
- commercial laundries
- funeral homes
- schools
- nursing care facilities
- personal care homes with more than six (6) clients
- child or adult day care facilities with more than six (6) clients
- residential facilities containing food service establishments

If proposal will use on-site sewage disposal, please contact the Land Use Section (404) 508-7900.

Any proposal, which will alter wastewater flow to an on-site sewage disposal system, must be reviewed by this office prior to construction.

This office must approve any proposed food service operation or swimming pool prior to starting construction.

Public health recommends the inclusion of sidewalks to continue a preexisting sidewalk network or begin a new sidewalk network. Sidewalks can provide safe and convenient pedestrian access to a community-oriented facility and access to adjacent facilities and neighborhoods.

For a public transportation route, there shall be a 5ft. sidewalk with a buffer between the sidewalk and the road. There shall be enough space next to sidewalk for bus shelter's concrete pad installation. Recommendation: Provide trash can with liner at each bus stop with bench and monitor for proper removal of waste.

Since DeKalb County is classified as a Zone 1 radon county, this office recommends the use of radon resistant construction.

Board of Health

- N.1 **TA-21-1244539 2021-2108**
County-Wide (All District)
36
- N.2 **LP-21-1243933 2021-2109/18-011-06-001,18-011-06-004,18-011-06-005,18-011-06-006,18-011-06-007**
 District 04 Super District 06
 3581 Rockbridge Road, Stone Mountain, GA 30083
 3605 Rockbridge Road, Stone Mountain, GA 30083
 3611 Rockbridge Road, Stone Mountain, GA 30083
 3599 Rockbridge Road, Stone Mountain, GA 30083
 3593 Rockbridge Road, Stone Mountain, GA 30083
 3581 Rockbridge Road, Stone Mountain, GA 30083
 - **Please review general comments**
 - **Septic system installed on September 23, 1960 for property 3605**
 - **Septic system installed on September 23, 1960 for property 3611**
 Total acres 4.8
- N.3 **Z-21-1243934 2021-2110 / 18-011-06-001, 18-011-06-004,18-011-06-005,18-011-06-006,18-011-06-007**
 District 04 Super District 06
 3581 Rockbridge Road, Stone Mountain, GA 30083
 3605 Rockbridge Road, Stone Mountain, GA 30083
 3611 Rockbridge Road, Stone Mountain, GA 30083
 3599 Rockbridge Road, Stone Mountain, GA 30083
 3593 Rockbridge Road, Stone Mountain, GA 30083
 3581 Rockbridge Road, Stone Mountain, GA 30083
 - **Please review general comments**
 - **Septic system installed on September 23, 1960 for property 3605**
 - **Septic system installed on September 23, 1960 for property 3611**
 Total acres 4.8
- N.4 **LP-21-1244555 2021-2111 / 15-162-04-008** District 05 Super District 07
 5011 Covington Highway, Decatur, GA 30035
 - Please review general comments
 Total acres 0.61
- N.5 **Z-21-1244408 202102112 / 15-162-04-008** District 05 Super District 07
 5011 Covington Highway, Decatur, GA 30045
 - Please review general comments
 Total acres 0.61
- N.6 **LP-21-1244580 2021-2113 / 16-168-01-008** District 05 Super District 07
 2346 Pine Mountain Street, Lithonia, GA 30058
 - Please review general comments
 Total acres 1.2

Board of Health

- N.7 **Z-21-1244581 2021-2114 / 16-168-01-008** District 05 Super District 07
2346 Pine Mountain Street, Lithonia, GA 30058
- Please review general comments
Total acres 1.2
- N.8 **TA-21-1244599 2021-2115** District 02 Super District 06
North Druid Hills Briarcliff Node, Atlanta, GA 30329
- Please review general comments
Total acres (not stated)
- N.9 **Z-21-1244535 2021-2116 / 18-152-01-005, 18-152-01-006, 18-152-01-054**
District 02 Super District 06
2490 North Druid Hills Road, Atlanta, GA 30329
- Please review general comments
- Several surrounding properties with septic system installed
Total acres 5.6
- N.10 **LP-21-1244541 2021-2117 / 16-167-08-010** District 05 Super District 07
2328 Pine Mountain Street, Lithonia, GA 30058
- Please review general comments
- Several surrounding properties with septic system installed
Total acres 0.79
- N.11 **Z-21-1244542 2021-2118 / 16-167-08-010** District 05 Super District 07
2328 Pine Mountain Street, Lithonia, GA 30058
- Please review general comments
- Several surrounding properties with septic system installed
Total acres 0.79

DeKalb County Board of Health

445 Winn Way – Box 987

Decatur, GA 30031

404.294.3700 • www.dekalbhealth.net

**DeKalb County School District
Development Review Comments**

Analysis Date: 2/8/2021

Submitted to: DeKalb County

Case #: Z-21-1244531

Parcel #: 18-045-08-001/003/004/005/006/007/008/095

Name of Development: Northern Ave. at Indian Creek Way
Location: 623,631,641,649,655,635,657,671 Northern Avenue

Description: Proposed attached and detached homes off Northern Avenue

Impact of Development: When fully constructed, this development would be expected to generate 43 students: 6 at Indian Creek Elementary School, 8 at Freedom Middle School, 9 at Clarkston High School, 17 at other DCSD schools, and 3 at private school. Enrollment at Clarkston HS is already above capacity and students from new development may cause additional strain. The new Replacement Indian Creek ES will be opening Fall 2021, providing additional capacity for elementary students.

Current Condition of Schools	Indian Creek Elementary School	Freedom Middle School	Clarkston High School	Other DCSD Schools	Private Schools	Total
Capacity	1,200	1,251	1,190			
Portables	0	0	16			
Enrollment (Fcast. Oct. 2021)	849	1,116	1,513			
Seats Available	351	135	-323			
Utilization (%)	70.8%	89.2%	127.1%			
New students from development	6	8	9	17	3	43

New Enrollment	855	1,124	1,522
New Seats Available	345	127	-332
New Utilization	71.3%	89.8%	127.9%

Yield Rates	Attend Home School	Attend other DCSD School	Private School	Total
Elementary	0.0388	0.0782	0.0176	0.0449
Middle	0.0562	0.0147	0.0000	0.0236
High	0.0567	0.0180	0.0000	0.0249
Total	0.0506	0.0370	0.0059	0.0311
Student Calculations				
Proposed Units	151			
Unit Type	APT			
Cluster	Clarkston High School			
Units x Yield	Attend Home School	Attend other DCSD School	Private School	Total
Elementary	5.87	11.80	2.66	20.33
Middle	8.48	2.22	0.00	10.70
High	8.56	2.72	0.00	11.28
Total	22.91	16.74	2.66	42.31
Anticipated Students	Attend Home School	Attend other DCSD School	Private School	Total
Indian Creek Elementary School	6	12	3	21
Freedom Middle School	8	2	0	10
Clarkston High School	9	3	0	12
Total	23	17	3	43

Statement on Behalf of the Dial Heights and Northern Neighborhoods Planning Commission Presentation – March 4, 2021

Thank you to the members of the Planning Commission for sharing your time and care to support and advocate for your neighbors in DeKalb County.

I am Fran Mohr, Immediate Past President of the Dial Heights Neighborhood Association and resident of Dial Heights for 34 years. My statement represents the wishes and concerns of the community directly impacted by the proposed development.

The Dial Heights and Northern Avenue neighborhoods are comprised of single-family homes predominantly mid-century modern style and brick ranch with DeKalb County's signature feature of mature trees and greenspace. This area of DeKalb County is labeled a "suburban" thus supporting the desire to have this area be one of lower density and greenspace that supports good air quality, decreased water runoff and aesthetic, desirable neighborhoods. The woodlands also help mitigate some of the air and noise pollution stemming from I285.

The Dial Heights and Northern Avenue neighborhoods would prefer the parcels be acquired and used as a natural greenspace that would benefit the community and the environment. Being a part of the Park Bond green space buying program would be a perfect mechanism for such an acquisition.

If it is to be developed, we ask that you oppose the spot zoning to RSM. Instead we propose that all parcels remain or be changed to R-75 which is compatible with the adjoining single-family residential neighborhoods and is allowed in a designated Suburban area of the county's comprehensive plan. The current MR-2 zoning applied to the east side of the land, including the wetlands and floodplain is not an allowable zone within a Suburban designation. Battle Law is quick to point out there are MR-2 Zoned parcels to the north of the proposed development on Indian Creek Way. Those were built in the 1970's and grandfathered in as an exception to the Suburban land use designation. The rezoning request seeks to eliminate all characteristics of the existing R-75.

1) Density

- The density of proposed development along the outer perimeter of the site that directly abuts the Dial Heights Neighborhood, Northern Avenue, and the wetlands and floodplain of Indian Creek should most closely resemble R-75 zoning characteristics, including but not limited to maximum densities, minimum lot sizes, and setbacks. This will create a more realistic buffer of density, impacting noise, appeal, neighborhood characteristics, traffic, and runoff.
- As identified by the Planning Department, the proposed building heights of the single-family detached lots along the southern portion of the site needs to be clarified. A maximum of two stories would be consistent and more compatible with the one and two-story single-family homes to the west on Northern Avenue and to the south in Dial Heights.
- R-75 zoning and lower density would help address some of our main concerns caused by increased density: traffic and environmental impact, including water runoff and flooding,

**Statement on Behalf of the Dial Heights and Northern Neighborhoods
Planning Commission Presentation – March 4, 2021**

2) Traffic was - and is – a major concern.

Northern Avenue's ability to absorb an increase of traffic has been questioned at least as far back as the last two proposed developments: the 72-home development in 2006, and the school in 2010. It is important to note that the community was less concerned about an increase of traffic with the Fugee School as many of the students would be walking to school. We were supportive because the school benefitted the community.

We are concerned about an increase in traffic on Northern Avenue that already is overstressed, undermaintained, and does not meet current county standards and requirements of a Collector Street. Even with the decreased traffic during the pandemic, traffic is heavy, making it difficult to pull out from neighborhood streets and driveways quickly and safely. Northern Avenue also is used as a quick cut-through, adding to the volume and speed on the road.

The application states the developer would perform modifications that will 'lessen traffic congestion.' A move to maintain and rezone all parcels as R-75 to keep the density at a minimum would help provide one solution.

Battle Law also mentioned a bike lane would be added in front of the property as a bonus and solution to traffic. That is a requirement by DeKalb County and ultimately a possible solution if a bike lane is installed along the entire length of Northern Avenue and connects with the PATH installation along Church Street in Clarkston.

3) Environmental Concerns: Greenspace, water runoff, flooding, etc.

We agree with the Planning Department's desire to know what trees are being preserved to save as much of the existing tree canopy and native woodlands as possible to provide dense buffers between the proposed development and existing neighborhoods. The woodlands and greenspace support a healthier environment and help mitigate the air and noise pollution stemming from immediately adjacent I-285.

It appears the wetlands and floodplain areas of Indian Creek on the east perimeter are included in "enhance open space benefiting the community" to request increased density. The wetlands and floodplain of Indian Creek should be protected. Indian Creek is a major water artery in DeKalb County that runs through Dial Heights. County sewer lines for the neighborhood are installed alongside the creek and impacted by flooding.

In 2006, the developer, Emco Properties, worked closely with the surrounding neighborhoods to reach a compromise to build a maximum of 72 units, maintain dense buffers, and protect hardwood acreage and specimen trees in order to remain compatible with surrounding neighborhoods and to protect the wetlands and floodplain. As that developer did not honor that agreement, the clearing of some woodlands dramatically increased run off and resultant flooding of Indian Creek, which directly impacts the yards and basements of many Dial Heights homes.

**Statement on Behalf of the Dial Heights and Northern Neighborhoods
Planning Commission Presentation – March 4, 2021**

Silt buildup in and erosion along the creek banks undercutting trees and exposing tree roots continue to be issues and creates potentially dangerous situations. The present proposal seeks twice as many units, with much less greenspace. The proposed density and loss of woodlands would significantly increase the runoff and the frequency of the flooding and erosion of Indian Creek impacting downstream and adjacent properties.

~~~~~

Our community always will extend a welcome to new neighbors to this secret oasis of DeKalb County, but it doesn't have to be to the detriment of the existing neighborhoods.

If these parcels cannot be a public greenspace with a benefit to the wider community, please vote against spot zoning the current parcels in question to RSM. Instead, please consider recommending the MR-2 zoned parcels and wetland being rezoned to R75 to be compatible with the surrounding neighborhoods and suburban designation, to avoid overstressing an already inadequate Collector street, an overtaxed infrastructure, and to make less of a negative environmental impact.

Thank you

Fran Mohr, 436 Greenridge Circle, [kfmohr@comcast.net](mailto:kfmohr@comcast.net), 404-210-7341

~~~~~

Photos of Indian Creek from behind 436 Greenridge Circle. Small example of erosion, silt buildup and exposed tree roots. These large trees are in danger of falling potentially causing extensive property damage. DeKalb County sewage lines are buried in bank along creek.



**Statement on Behalf of the Dial Heights and Northern Neighborhoods
Planning Commission Presentation – March 4, 2021**

Creek has risen to this level
and out of the bank and
into our yards 3 times
since summer 2020.



**Statement on Behalf of the Dial Heights and Northern Neighborhoods
Planning Commission Presentation – March 4, 2021**



**Statement on Behalf of the Dial Heights and Northern Neighborhoods
Planning Commission Presentation – March 4, 2021**



**Statement on Behalf of the Dial Heights and Northern Neighborhoods
Planning Commission Presentation – March 4, 2021**



From: rita valenti <rita1880@att.net>
Subject: Proposed Rezoning on Northern Avenue, Clarkston 30021
Date: February 28, 2021 at 7:00:39 PM EST
To: Rita Valenti <rita1880@att.net>

Dear Commissioner Bradshaw,

I and dozens of my neighbors urge you to deny the InLine Communities LLC proposal to rezone 8 properties, roughly 22 acres of land on Northern Avenue from R75 to RSM.

I have lived on Northern Avenue for 38 years, initially at what was then Barron Estates Apartments and now in my home at 660 Northern Avenue.

The property in question currently has two inhabited houses and was formerly the site of three other homes. In short, what is being proposed is a change from 5 residential homes with wooded areas, a wet land and flood plain into a development of 149 residences. The poorly thought out proposed development and rezoning includes a 'postage stamp' of greenspace; virtually NO space between the proposed townhouses & single family barely detached homes; new asphalt roads in the development and a plan for two entries and exits onto Northern Avenue. The latter configuration of two roads emptying onto Northern, a busy collector street with frequent traffic of fire trucks, ambulances, school buses (pre-pandemic) and Marta Mobility Paratransit Service vans should be enough in itself to deny this ridiculously dense development. It is not only a question of increased traffic, it is a question of safety. Any entrances on Northern from this overly dense development is dangerous. The property lies between a very hazardous curb and a blind hill that severely limits vision of oncoming traffic in all directions. Indeed, many of us leaving our driveways on Northern, roll down our windows to try to listen for oncoming traffic - because we can't see it. Further, we do not support an entry/exit in Dial Heights either, another neighboring residential area.

This property has a long history. As mentioned, roughly 11 acres of the property was once home to three residences. When the wonderful matriarch of the property at 655 Northern site moved to a personal care home, all three properties were sold to a developer who proceeded to clear cut the land, including a 100 year old specimen oak tree that had been circled to be saved and along with scores of other old growth trees. The contractors left nothing but spindly pines at the ends and sides of the property. Drainage, flooding and runoffs became problematic for contingent home owners. Further, the contractors tore up the street and my neighbor's driveway and when asked about making repairs to the damage they had done, were physically menacing to me and my neighbor, Mark Anthony. They violated with impunity every noise and 'work start time' ordinances and in general made our lives hell for a few years. We do not intend to endure that again and we have concerns about the lack of a track record or even a website for this InLine Communities. Subcontractors that InLine sent to the property for 'due diligence' brought a huge bulldozer and drilling machines and those operators were unable and/or unwilling to provide information about who they worked for and what notice had been given to the community about their noisy land disturbing actions.

Aerial photos provided by the developer do not accurately reflect this community. Northern Avenue is a residential street with all but two homes at one story and three smaller acreage, low height quiet apartment complexes with long-term renters. Most of our homes are, even now, still affordable. Dial

Heights is a community of ranch homes. We are a suburban community. The sheer density of the proposal would more than double the amount of currently existing homes on a street already challenged by traffic, sewer infrastructure, and shrinking greenspace. To quote from Dekalb County Greenspace Program, "Though many consider green space a mere luxury, in Dekalb County it is a rapidly disappearing necessity....Greenspace also helps the community at large by lowering crime and reducing the cost of public services such as police protection and sewer and road maintenance. Not only does our air quality benefit, but treating drinking water also becomes easier and more affordable if we allow the waterways and surrounding ecosystems to naturally cleanse themselves." Of note, there is significant wetland space in the back of this property and Indian Creek runs throughout a number of properties on the east side of Northern. The impact of this development could have a larger environmentally negative effect beyond what is currently being addressed. While it is true that there was a 'rezoning' to MR-2 on a small section of this property, that was done ONLY because the community as a whole supported and felt it would be beneficial to locate a small school specifically for the neighboring immigrant and refugee children. Most folks on Northern Avenue do NOT see any benefit to the existing community from this development.

I am no expert on zoning. But I am an expert on where I live and the quality of life I and many of my neighbors want to maintain. Just because something can be done it doesn't mean it should be done. The first step in this process is to deny the rezoning request to RSM. It is simply not compatible with the existing community. Thank you for your service and your attention to this matter. I am more than happy to discuss my concerns with any of the decision makers in this process and am hopeful that the views of those impacted by this proposal will be given the most weight. Thank you again.

Sincerely,

Rita Valenti
660 Northern Avenue
Clarkston, GA 30021
rita1880@att.net
678-328-8725
404-292-1219

FW: Community feedback opposing Northern Ave rezoning to MR-2 (Z-21-1244531)

Plansustain <plansustain@dekalbcountyga.gov>

Tue 3/2/2021 9:48 AM

To: 'hope.ranker@gmail.com' <hope.ranker@gmail.com>**Cc:** Reid, John <jreid@dekalbcountyga.gov>

Good day, Ms. Ranker. That case is on this Thursday evening's Planning Commission agenda and your email has been forwarded to them and the Sr. Planner (John Reid) assigned to this case.

Thank you.

From: Hope Ranker <hope.ranker@gmail.com>**Sent:** Tuesday, March 2, 2021 4:22 AM**To:** Terry, Edward C. <ecterry@dekalbcountyga.gov>; Bradshaw, Stephen R. <SRBradshaw@dekalbcountyga.gov>; Plansustain <plansustain@dekalbcountyga.gov>**Cc:** Cato, Kelly E. <kecato@dekalbcountyga.gov>; Brooks, Alesia D. <adb Brooks@dekalbcountyga.gov>; Public Hearing <PublicHearing@dekalbcountyga.gov>**Subject:** Community feedback opposing Northern Ave rezoning to MR-2 (Z-21-1244531)

Commissioners Terry and Bradshaw, and other Planning Commission members:

I'm writing to you as a community member to urge you to deny the request of Inline Communities to rezone 22 acres on Northern Ave, petition number Z-21-1244531. The proposed development would do great harm to our community: It would economically endanger and displace our low-income and refugee neighbors, it would increase the traffic danger of an already too-busy road, and it is generally far out of character with the other properties in our neighborhood.

My name is Hope Ranker. Since 2009 my wife and I have lived at 703 Northern Ave, three lots north of the subject property.

My primary concern is the massive social harm the proposed development would do to this suburban neighborhood. Many members of our neighborhood belong to Clarkston's beloved and internationally-recognized refugee community. Like much of the area around Clarkston, incomes are modest: The census tract that contains the subject property has a median household income of \$35k, with \$37k across the street to the west and \$29k across the street to the north. I'll list sources and notes below. Median house values around the property and west across Northern are \$150k. Just across the property's eastern creek and north across Indian Creek Way they are \$75-85k.

According to Ms Battle's presentation at the Community Council meeting, Inline intends to sell its townhomes starting at \$300k, and houses starting at \$450k. The zoning application represents this as "equal to or greater than surrounding home values." This is a huge understatement: It's 2-3 times the median cost of houses to the south and west, and it's 4-6 times the median cost of the condos to the east and north. It's more than median-income neighbors will make in ten years. This is a shocking figure for this neighborhood, and it marks the bottom end of this developer's range. Studies clearly and consistently show that this style of gentrification displaces vulnerable populations like our low-income and refugee neighbors. This is deeply inappropriate and causes direct and clear harm to the community of people who live here.

Secondary to the grievous social impact of this rezoning, it will also increase the already-high danger to me and my neighbors from traffic on Northern Ave. I live just north of the intersection of Northern and Indian Creek Way. In the vicinity of my house and the subject property, there are a series of blind turns and hills. As I leave my driveway I have about 300 feet of visibility in either direction. The county is unable to put speed bumps on the

road, and people regularly speed down it, losing control and crashing at least yearly into my yard or a neighbor's. My wife and I haven't bothered putting up a mailbox because our neighbors' get knocked down every few years.

Someone suggested at the Community Council meeting that more cars may slow down traffic in this section of the road. The applicant's traffic study seems to assure us that it won't. They carefully studied the expected impact of the development on the intersections, including the one right by me and the subject property. They found that rush hour traffic in front of my driveway will increase 11% from 5.7 cars per minute to 6.3, but that it won't cause any slowdown of traffic through our intersection. With Inline's proposed development I will be facing less than ten seconds between each speeding car as I try to leave my driveway with three hundred feet of road visibility. Fixing these problems is outside the scope of zoning, but it's not unfair to ask zoning to refrain from further exacerbating an already difficult road. If instead this application is accepted, I'm left wondering if crashes into my yard and my neighbors' will also increase by 11%.

Finally, aside from socioeconomic harm to the community and the increased traffic risk to me and my nearby neighbors, this proposed development simply doesn't fit in our community. Please take a moment to drive down Northern Ave if you live nearby, or if you don't, use online maps to do it virtually. You'll see that our street is a small, spread out neighborhood of modest homes surrounded in trees and green space. The applicants point out the density of nearby Navarro apartments (19 du/ac), but I would challenge the numbers they found: I calculate them at 12 du/ac, which I'll explain in notes below. If you take a virtual drive down Indian Creek Way you'll see that most of the complexes there had designers take care to incorporate pleasing building arrangements, green spaces, and trees to keep them as appealing as they could manage. Inline's proposed development would stick out like a sore thumb so close to any of the other MR-2 complexes in the area.

Ms Battle is an accomplished professional. Inline Communities hired her to make the case that their zoning change is fair, reasonable, and in line with development in the local community. Speaking as someone whose life and property would be directly negatively impacted by their development, I hope I've painted a very different picture. Inline's development is no fit at all for this community. It would increase danger on an already difficult road. And most importantly the shocking wealth disparity it proposes introducing into this neighborhood would cause long-lasting irreparable socioeconomic harm to my most vulnerable neighbors. I urge you to reject this deeply harmful application.

Thank you for your attention.

Hope Ranker
703 Northern Ave
678.524.2422
hope.ranker@gmail.com

NOTES

Median household income data is from the US Census Bureau's American Community Survey (2013-2017). The subject property is at the northwest corner of census tract 220.05. There's a nice visualization at:

<http://www.justicemap.org/index.php?gsLayer=&gfLon=-84.23865199&gfLat=33.80426593&giZoom=14&>

My median house value numbers are from:

<http://www.city-data.com/city/Clarkston-Georgia.html>

in the map visualization a few screens down. The site doesn't provide reliable citations, but the numbers are in line with a cursory review of Dekalb county's GIS site, which includes property values from tax records:

<https://dekalbgis.maps.arcgis.com/apps/webappviewer/index.html?id=f241af753f414cdfa31c1fdef0924584>

There's a long list of studies examining the displacement of vulnerable communities from gentrification here:

<https://www.urbandisplacement.org/publications>

The University of Texas maintains a site with a few detailed case studies:

<https://sites.utexas.edu/gentrificationproject/case-studies/>

And the CDC maintains a list of references describing the public health impact of this sort of vulnerable population displacement:

<https://www.cdc.gov/healthyplaces/healthtopics/gentrification.htm>

I've been unable to find complete documentation for the vehicular crashes that plague our road. The DOT's site can be filtered by street name and date, but it's missing a lot of crashes that my neighbors can attest to:

https://gdot.numeric.net/crash-data#/?view_id=7

If you need substantiation of accident frequency, I can reach out to neighbors, several of whom keep thorough notes and pictures.

The traffic study doesn't list cars passing my house, but the appendix tables include cars entering the intersection of Northern and Indian Creek Way from the north and leaving it in that direction. Since I'm the second property north of that intersection, nearly all of those cars speed past my driveway.

You can drive up and down Northern here, facing north (toward Indian Creek Way and my house) just in front of the subject property:

https://www.google.com/maps/@33.7949984,-84.2462329,3a,75y,23.68h,90t/data=!3m7!1e1!3m5!1sPICglfrYp7f7yLAG_w3IYg!2e0!6s%2F%2Fgeo3.ggpht.com%2Fcbk%3Fpanoid%3DPICglfrYp7f7yLAG_w3IYg%26output%3Dthumbnail%26cb_cli

The zoning application shows Navarro Apartments with a density of 19 du/ac. This is an easy mistake to make, but it is a mistake. Navarro Apartments consists of parcel ids 18 066 07 002 through 017. Commercial residential units are in 003 through 017. 002 is the office, yards, and hardscape. If you exclude 002 then the 52 units are split across 2.63 acres, for a density of 19.8 du/ac. If you include 002, the same 52 units are split across 4.17 acres, for a density of 12.5 du/ac. A visual inspection of the property at the county GIS site will clearly show that 002 is part of the complex.

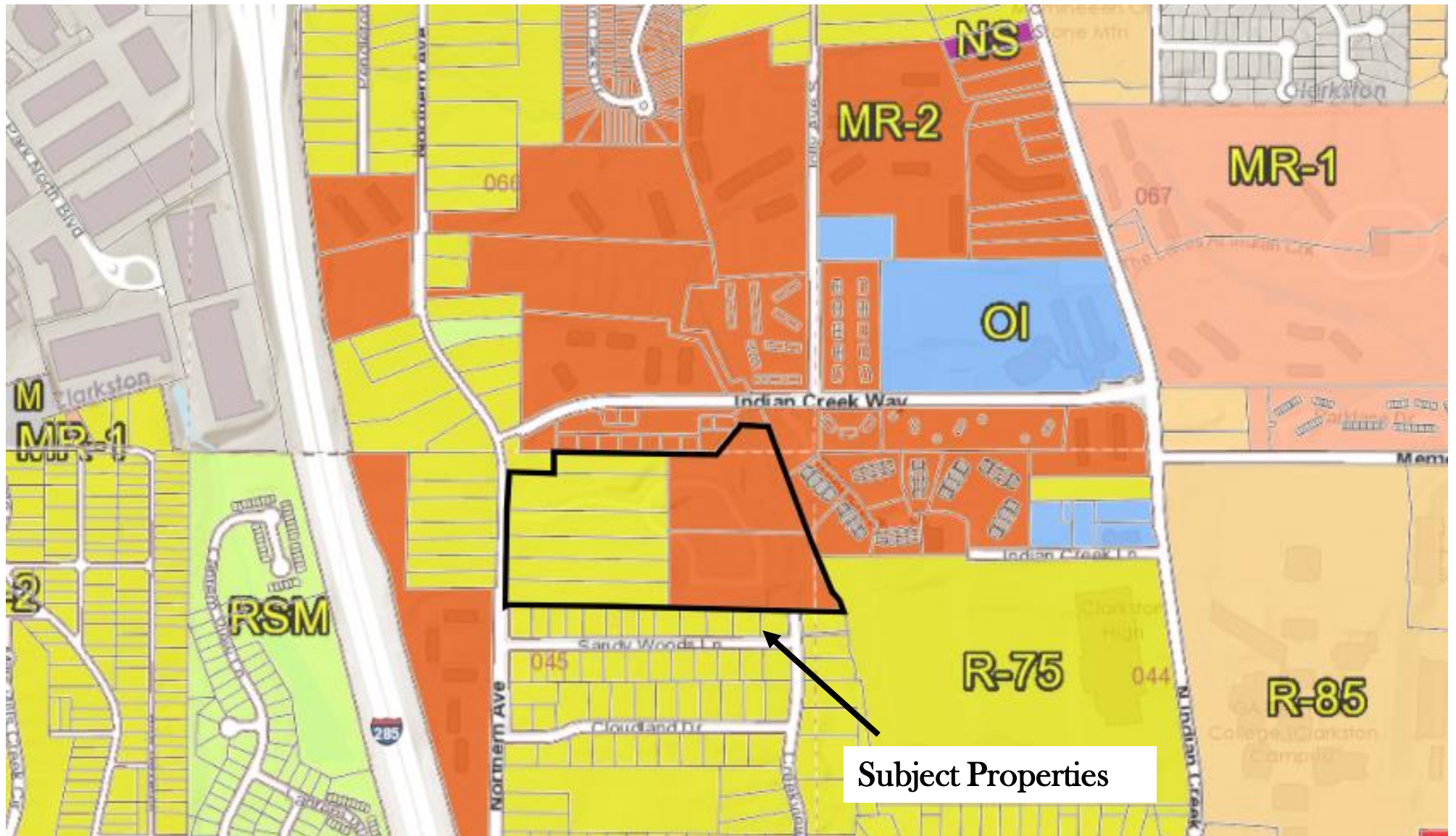

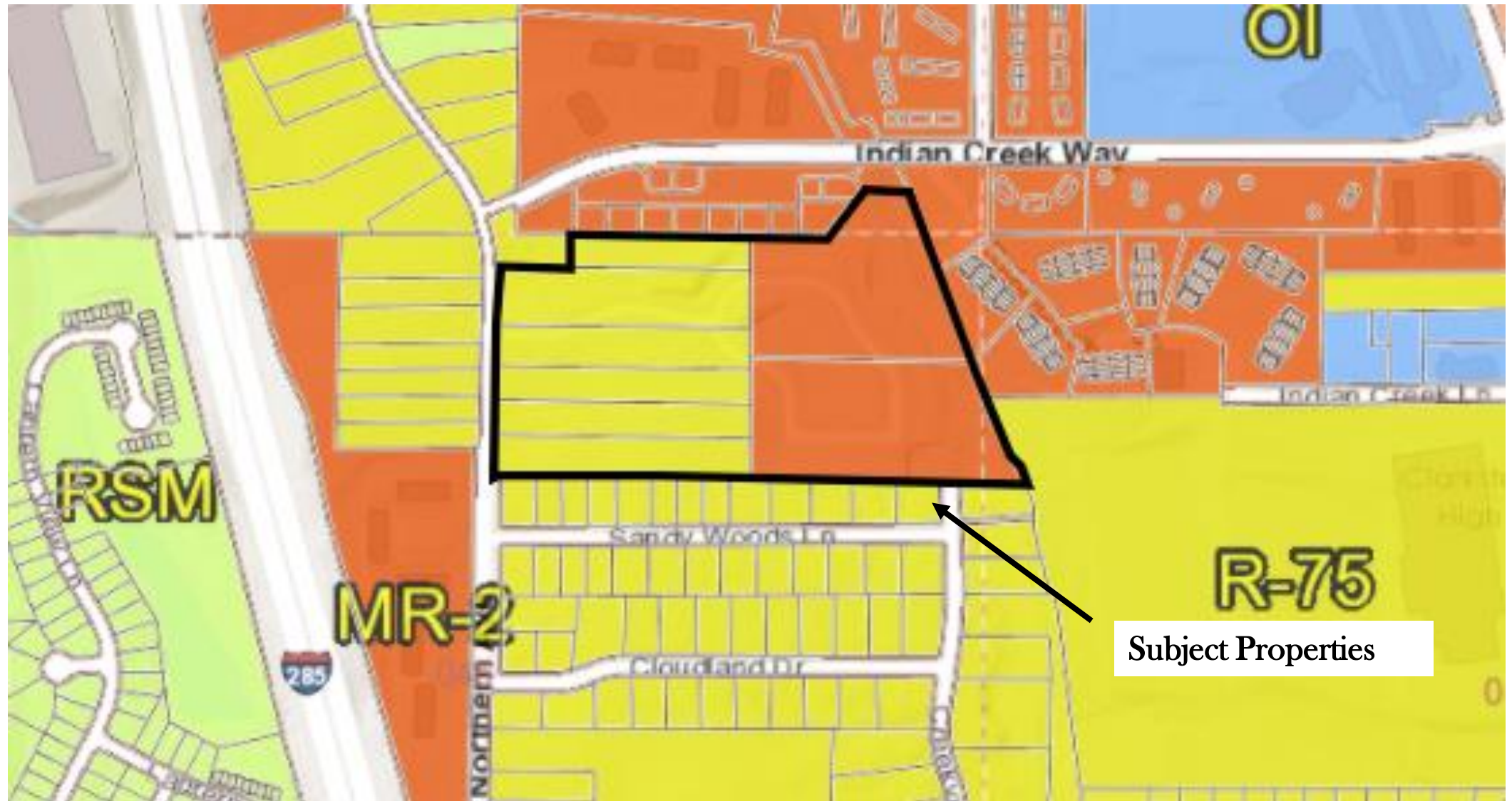





Subject Properties

CURRENT ZONING IS APPROVED FOR PRIVATE SCHOOL FOR 120 STUDENTS

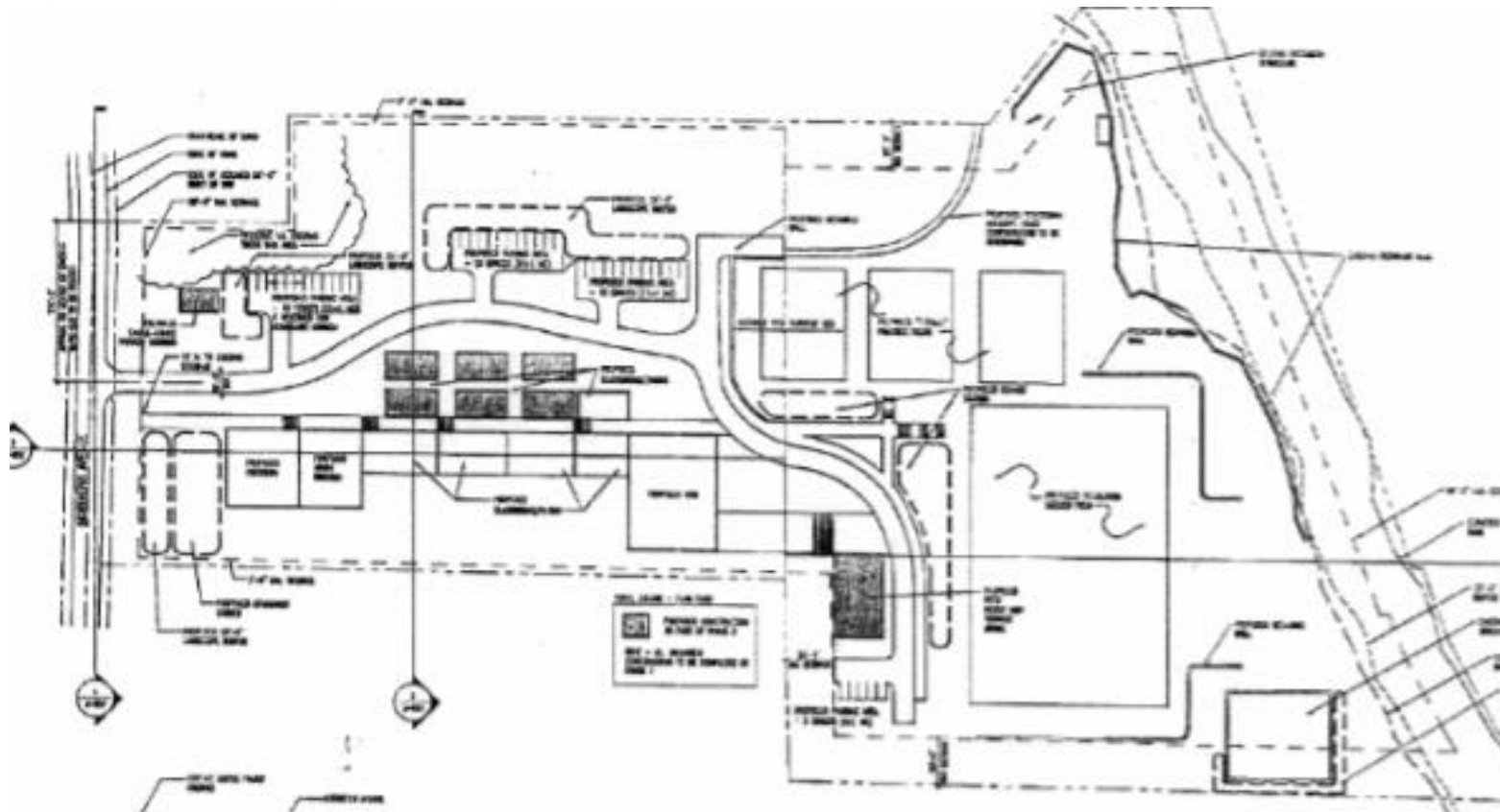

DeKalb County **approved** a Special Land Use Permit in June 2010, inclusive of the following uses:

- Private middle school w/ a max capacity of 120 students
- Two soccer fields
- Faculty residence
- Community garden

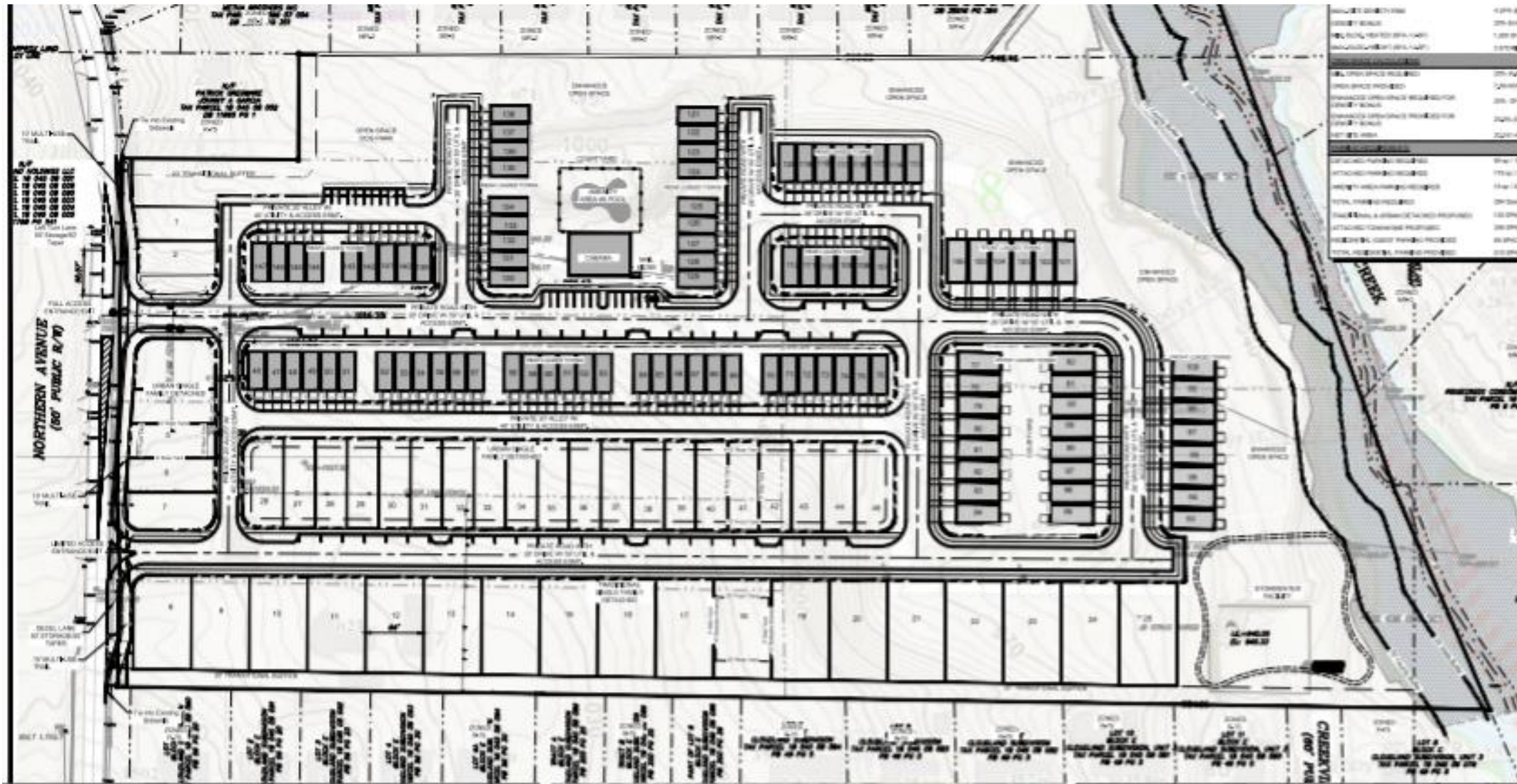

Adjacent Land Uses



Adjacent Multi-Family Densities





INLINE
COMMUNITIES



INLINE
COMMUNITIES

Architecture Examples – Elevations



Architecture Examples – Elevations



APPLICATION TO AMEND OFFICIAL ZONING MAP OF DEKALB COUNTY, GEORGIA

Z/CZ No. _____

Filing Fee: _____

Date Received: _____ Application No.: _____

Applicant: Inline Communities LLC c/o Battle Law PC E-Mail: mlb@battlelawpc.com

Applicant Mailing Address: One West Court Square, Suite 750, Decatur GA 30030

Applicant Phone: (404) 601-7616 Fax: (404) 745-0045

Owner(s): Refer to attachment E-Mail: _____
(If more than one owner, attach as Exhibit "A")

Owner's Mailing Address: _____

Owner(s) Phone: _____ Fax: _____

Address/Location of Subject Property: 671, 657, 635, 655, 649, 641, 631, 623 Northern Ave Clarkston GA 30021

District(s): 18 Land Lot(s): 045 Block: 08 Parcel(s): 095, 001, 008, 003, 005, 006, 007, 004

Acreage: 22.07 Commission District(s): District 4, Super District 6

Present Zoning Category: R-75 & MR-2 Proposed Zoning Category: RSM

Present Land Use Category: Suburban

PLEASE READ THE FOLLOWING BEFORE SIGNING

This form must be completed in its entirety before the Planning Department accepts it. It must include the attachments and filing fees identified on the attachments. An application, which lacks any of the required attachments, shall be determined as incomplete and shall not be accepted.

Disclosure of Campaign Contributions

**TRAFFIC IMPACT STUDY
FOR
RESIDENTIAL DEVELOPMENT ON NORTHERN AVENUE
DEKALB COUNTY, GEORGIA**



Prepared for:

***Inline Communities, LLC.
48 Atlanta Street
Marietta, GA 30060***

Prepared By:



A&R Engineering Inc.

2160 Kingston Court, Suite O
Marietta, GA 30067
Tel: (770) 690-9255 Fax: (770) 690-9210
www.areng.com

January 14, 2021
A & R Project # 20-147

TABLE OF CONTENTS

Item	Page
1.0 Introduction	1
2.0 Existing Facilities / Conditions	3
2.1 Roadway Facilities.....	3
2.1.1 Church Street	3
2.1.2 Northern Avenue	3
2.1.3 Indian Creek Way	3
2.1.4 N. Indian Creek Drive	3
2.1.5 N. Decatur Road	3
3.0 Study Methodology	4
3.1 Unsignalized Intersections	4
3.2 Signalized Intersections	4
4.0 Existing 2021 Traffic Analysis.....	6
4.1 Existing Traffic Volumes	6
4.2 Existing Traffic Operations	7
5.0 Proposed Development.....	11
5.1 Trip Generation	11
5.2 Trip Distribution	11
6.0 Future 2023 Traffic Analysis	14
6.1 Future “No-Build” Conditions	14
6.1.1 Annual Traffic Growth.....	14
6.2 Future “Build” Conditions	14
6.3 Auxiliary Lane Analysis	14
6.3.1 Left Turn Lane Analysis	15
6.3.2 Deceleration Turn Lane Analysis	15
6.4 Future Traffic Operations.....	18
7.0 Conclusions and Recommendations.....	20
7.1 Site Access Configuration.....	20
Appendix	

LIST OF TABLES

Item	Page
Table 1 – Level-of-service Criteria for Unsignalized Intersections.....	4
Table 2 – Level-of-service Criteria for Signalized Intersections	5
Table 3 – Existing Intersection Operations	7
Table 4 – Trip Generation	11
Table 5 - GDOT Requirements for Left Turn Lanes	15
Table 6 - GDOT Requirements for Deceleration Lanes	15
Table 7 – Future Intersection Operations	18

LIST OF FIGURES

Item	Page
Figure 1 – Location Map.....	2
Figure 2 – Existing Weekday Peak Hour Volumes during Covid-19	8
Figure 3 – Adjusted Existing Weekday Peak Hour Volumes	9
Figure 4 – Existing Traffic Control and Lane Geometry	10
Figure 5 – Site Plan.....	12
Figure 6 – Outer Leg Trip Distribution and Site Generated Peak Hour Volumes.....	13
Figure 7 – Future (No-Build) Peak Hour Volumes.....	16
Figure 8 – Future (Build) Peak Hour Volumes.....	17
Figure 9 – Future Traffic Control and Lane Geometry	19

1.0 INTRODUCTION

The purpose of this study is to determine the traffic impact that will result from the proposed residential development located in the southeast corner of the intersection of Northern Avenue and Indian Creek Way in DeKalb County, Georgia. The traffic analysis evaluates the current operations compared to the future conditions with the traffic generated by the development. The proposed development will consist of:

- 26 Single-family detached housing units and
- 139 Multifamily Low-Rise Housing units

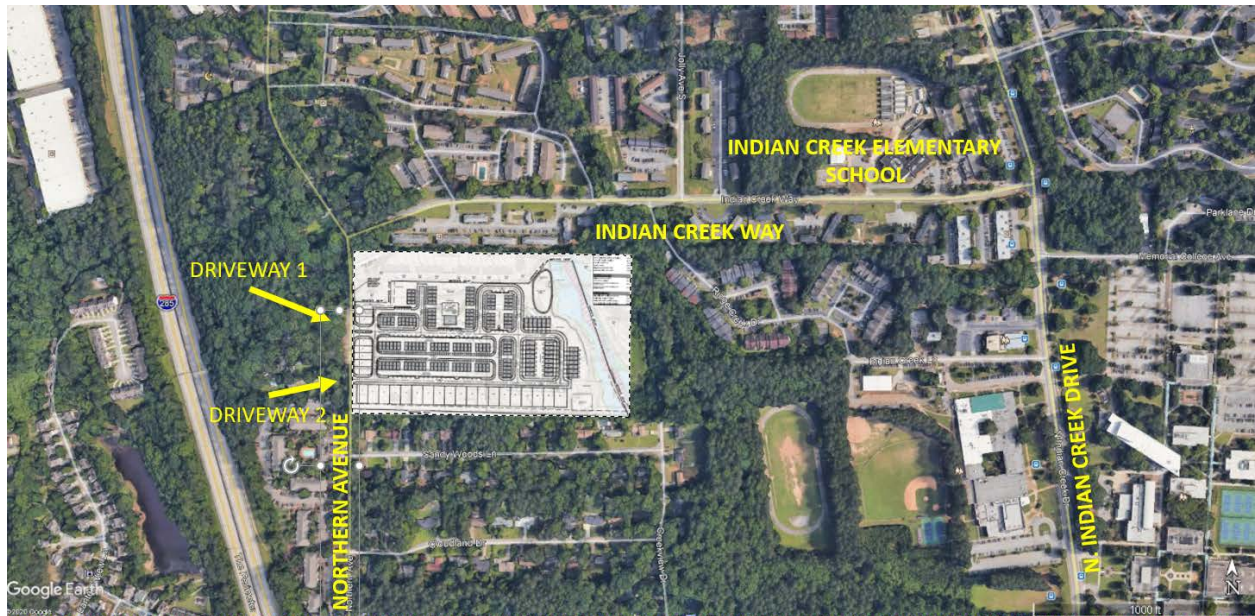

The development proposes access at the following locations:

- Site Driveway 1: Full-access (northern) driveway on Northern Avenue
- Site Driveway 2: Full-access (southern) driveway on Northern Avenue

The AM and PM peak hours have been analyzed in this study. In addition to the site driveways, this study includes the evaluation of traffic operations at the intersections of:

- Church Street at Northern Avenue
- Northern Avenue at Indian Creek Way
- N. Decatur Road at Northern Avenue
- N. Indian Creek Drive at Indian Creek Way

Recommendations to improve traffic operations have been identified as appropriate and are discussed in detail in the following sections of the report. The location of the development and the surrounding roadway network is shown in Figure 1.

⊕ - Study Intersection

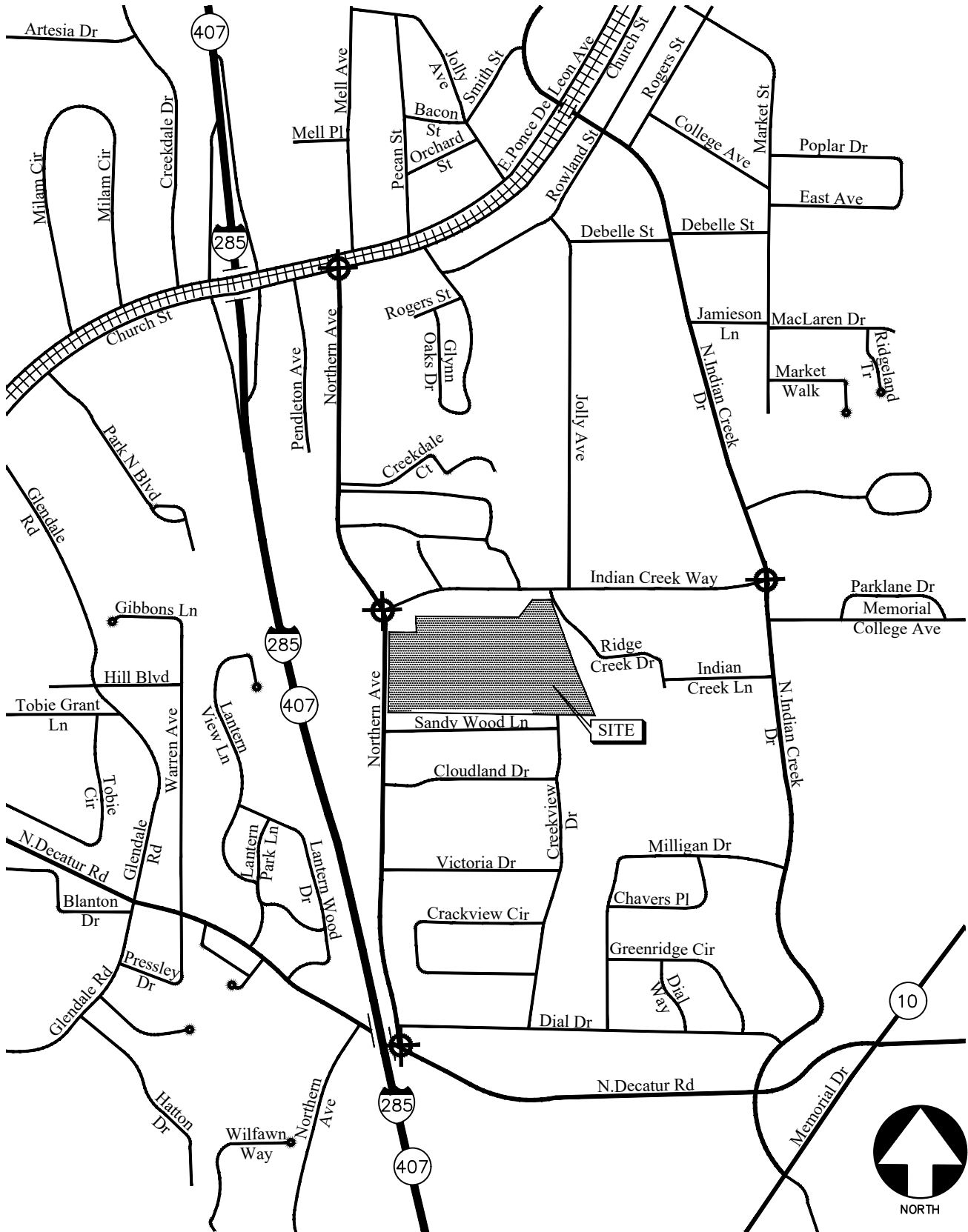

LOCATION MAP

FIGURE 1

A&R Engineering Inc.

2.0 EXISTING FACILITIES / CONDITIONS

2.1 Roadway Facilities

The following is a brief description of each of the roadway facilities located in proximity to the site:

2.1.1 Church Street

Church Street is an east-west, two-lane, undivided roadway with a posted speed limit of 35 mph in the vicinity of the site.

2.1.2 Northern Avenue

Northern Avenue is a north-south, two-lane, undivided roadway with a posted speed limit of 35 mph in the vicinity of the site.

2.1.3 Indian Creek Way

Indian Creek Way is an east-west, two-lane, undivided roadway with a posted speed limit of 35 mph.

2.1.4 N. Indian Creek Drive

N. Indian Creek Drive is a north-south, three-lane roadway with a two-way left-turn lane and posted speed limit of 35 mph in the vicinity of the site. GDOT traffic counts (Station ID 089-3754) indicate that the daily traffic volume on N. Indian Creek Drive in 2019 was 17,400 vehicles per day north of Indian Creek Way. GDOT classifies N. Indian Creek Drive as an Urban Minor Collector roadway.

2.1.5 N. Decatur Road

N. Decatur Road is an east-west, four-lane, undivided roadway with a posted speed limit of 40 mph in the vicinity of the site. GDOT traffic counts (Station ID 089-3729) indicate that the daily traffic volume on N. Decatur Road in 2019 was 15,200 vehicles per day between Northern Avenue and N. Indian Creek Drive. GDOT classifies N. Decatur Road as an Urban Minor Arterial roadway.

3.0 STUDY METHODOLOGY

In this study, the methodology used for evaluating traffic operations at each of the subject intersections is based on the criteria set forth in the Transportation Research Board's Highway Capacity Manual, 6th edition (HCM 6). Synchro software, which utilizes the HCM 6 methodology, was used for the analysis. The following is a description of the methodology employed for the analysis of unsignalized and signalized intersections.

3.1 Unsignalized Intersections

For unsignalized intersections at which the side street or minor street is controlled by a stop sign, the criteria for evaluating traffic operations are the level-of-service (LOS) for the turning movements at the intersection and the level-of-service for the overall intersection. Level-of-service is based on the average controlled delay incurred at the intersection. Controlled delay for unsignalized intersections includes initial deceleration delay, queue move-up time, stopped delay, and final acceleration delay. Several factors affect the controlled delay for unsignalized intersections, such as the availability and distribution of gaps in the conflicting traffic stream, critical gaps, and follow-up time for a vehicle in the queue.

Level-of-service is assigned a letter designation from "A" through "F". Level-of-service "A" indicates excellent operations with little delay to motorists, while level-of-service "F" exists when there are insufficient gaps of acceptable size to allow vehicles on the side street to cross safely, resulting in extremely long total delays and long queues. The level-of-service criteria for two-way stop-controlled and all-way stop-controlled (unsignalized) intersections are given in Table 1.

Level-of-service	Average Delay (sec)
A	≤ 10
B	> 10 and ≤ 15
C	> 15 and ≤ 25
D	> 25 and ≤ 35
E	> 35 and ≤ 50
F	> 50

Source: Highway Capacity Manual

3.2 Signalized Intersections

For signalized intersections, it is necessary to evaluate both capacity and level-of-service in order to evaluate the overall operation of the intersection. The capacity analysis of an intersection is performed by comparing the volume of traffic using the various lane groups at the intersection to the capacity of those lane groups. This results in a volume/capacity (v/c) ratio for each lane group. A v/c ratio greater than 1.0 indicates that the volume of traffic has exceeded the capacity available, resulting in a temporary excess of demand. Although the capacity of the entire intersection is not defined, a composite v/c ratio for the sum of the critical lane groups within the intersection is computed. This composite v/c ratio is an indication of the overall intersection sufficiency.

Level-of-service for a signalized intersection is defined in terms of average controlled delay per vehicle, which is composed of initial deceleration delay, queue move-up time, stopped delay, and final acceleration delay. The level-of-service criteria for signalized intersections, based on average controlled delay, are shown in Table 2. Level-of-service “A” indicates operations with very low controlled delay, while level-of-service “F” describes operations with extremely high average controlled delay. Level-of-service “E” is typically considered to be the limit of acceptable delay, and level-of-service “F” is considered unacceptable by most drivers.

TABLE 2 – LEVEL-OF-SERVICE CRITERIA FOR SIGNALIZED INTERSECTIONS	
Level-of-service	Average Control Delay (sec)
A	≤ 10
B	$> 10 \text{ and } \leq 20$
C	$> 20 \text{ and } \leq 35$
D	$> 35 \text{ and } \leq 55$
E	$> 55 \text{ and } \leq 80$
F	> 80

Source: Highway Capacity Manual

4.0 EXISTING 2021 TRAFFIC ANALYSIS

4.1 Existing Traffic Volumes

Existing traffic counts were obtained at the following study intersections:

- Church Street at Northern Avenue
- Northern Avenue at Indian Creek Way
- N. Decatur Road at Northern Avenue

Turning movement counts were collected on Thursday, January 7, 2021. All turning movement counts were recorded during the AM and PM peak hours between 7:00 AM to 9:00 AM and 4:00 PM to 6:00 PM, respectively. The four consecutive 15-minute interval volumes that summed to produce the highest volume at the intersections were then determined. These volumes make up the peak hour traffic volumes for the intersections counted and are shown in Figure 2.

We had evaluated the intersection of N. Indian Creek Drive and Indian Creek Way in 2018 for 2020 build-out year for the expansion of Indian Creek Elementary School from 950 students to 1,200 students. Since schools were closed at the time of collection of traffic counts now, we have used the projected Build 2020 traffic volumes at the intersection of N. Indian Creek Drive and Indian Creek Way, which included the 2018 traffic counts grown to 2020 and the projected school generated traffic after its expansion to 1,200 students. The 2020 build volumes from that project were grown for one year at a 1% growth rate to obtain the existing 2021 volumes. These 2021 volumes are also shown in Figure 2.

For the recently collected counts, since traffic patterns are irregular due to the COVID-19 pandemic, adjustment factors for the AM and PM peak hours were determined by comparing current traffic volumes to historic traffic volumes at a location that had historical GDOT counts available. GDOT had traffic counts available from 2009 at Station ID 089-3729 on N. Decatur Road. GDOT recorded counts from 2009 were increased by the annual growth rate of 1% for 12 years to project 2021 counts and compared to the new counts collected. The comparison of the projected 2021 GDOT counts and the new counts revealed that historic traffic volumes are higher by 70% in the AM peak hour and higher by 15% in the PM peak hour. Therefore, new turning movement counts were increased by 70% in the AM peak hour and 15% in the PM peak hour at all study intersections except the intersection of N. Indian Creek Drive and Indian Creek Way (please see above paragraph explaining the methodology for this intersection). No other adjustments were made to the 2021 volumes at the N. Indian Creek Drive at Indian Creek Way intersection. The adjusted existing peak hour volumes are shown in Figure 3 and were used in the existing traffic operations analysis.

4.2 Existing Traffic Operations

Existing traffic operations were analyzed at the study intersections in accordance with the HCM methodology. The results of the analyses are shown in Table 3. The existing traffic control and lane geometry for the intersections are shown in Figure 4.

TABLE 3 – EXISTING INTERSECTION OPERATIONS				
	Intersection	Traffic Control	LOS (Delay)	
			AM Peak Hour	PM Peak Hour
1	Church Street @ Northern Avenue -Westbound Left -Northbound Approach	Stop Controlled on NB Approach	A (8.0) B (12.4)	A (8.5) B (12.3)
2	Northern Avenue @ Indian Creek Way -Westbound Approach -Southbound Left	Stop Controlled on WB Approach	A (9.8) A (7.6)	B (10.4) A (7.6)
3	N. Decatur Road St @ Northern Avenue -Eastbound Approach -Westbound Approach -Southbound Approach	Signalized	A (2.8) A (1.1) A (1.5) E (64.8)	A (5.1) A (2.0) A (1.6) E (68.1)
4	N. Indian Creek Drive @ Indian Creek Way -Eastbound Approach -Northbound Approach -Southbound Approach	Signalized	B (10.8) E (62.0) A (4.4) A (3.6)	B (11.5) E (61.3) A (5.2) A (6.2)

The results of existing traffic operations analysis indicate that all the study intersections are operating at satisfactory levels of service in both the AM and PM peak hours.

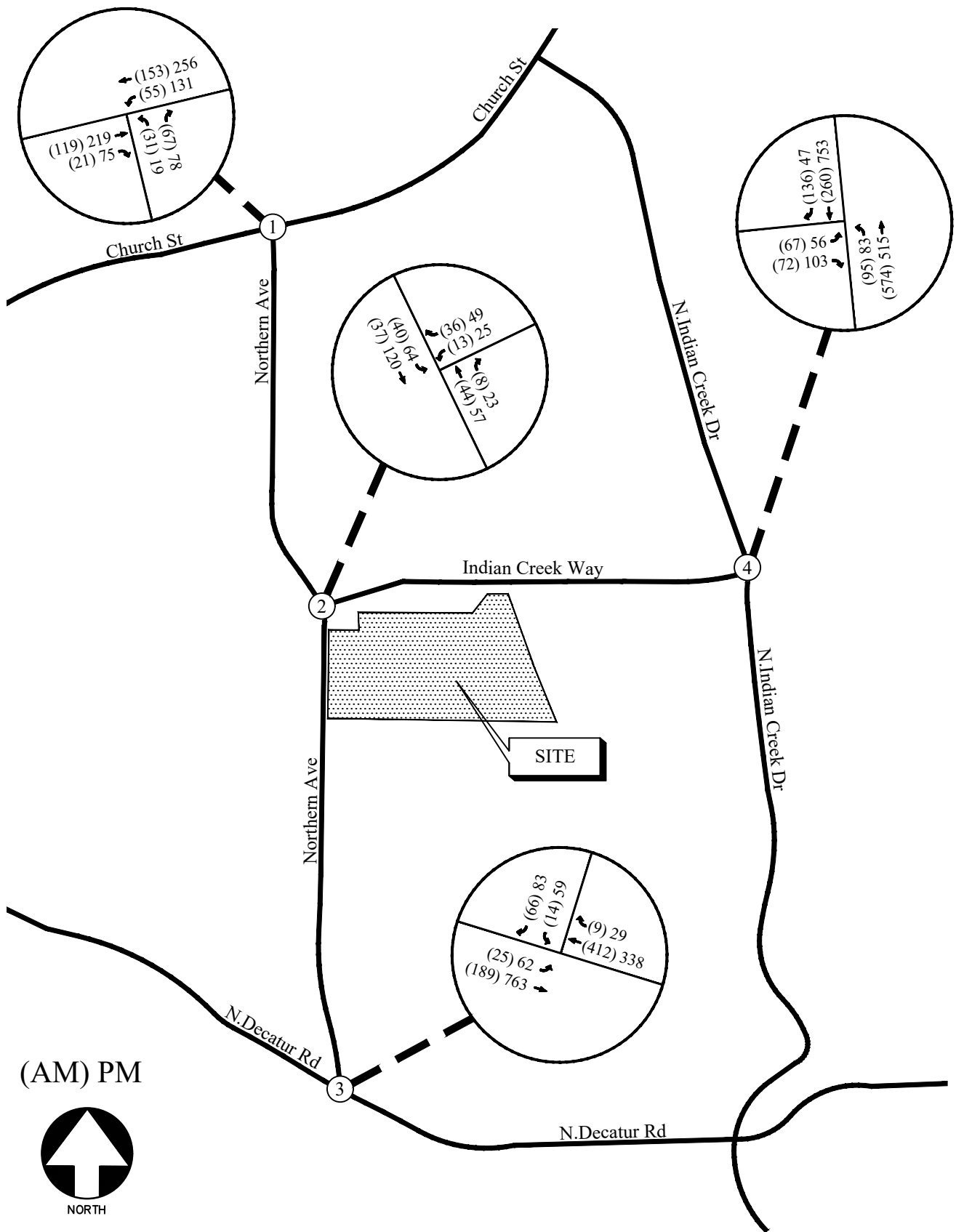

EXISTING WEEKDAY PEAK-HOUR VOLUMES
(DURING COVID-19)

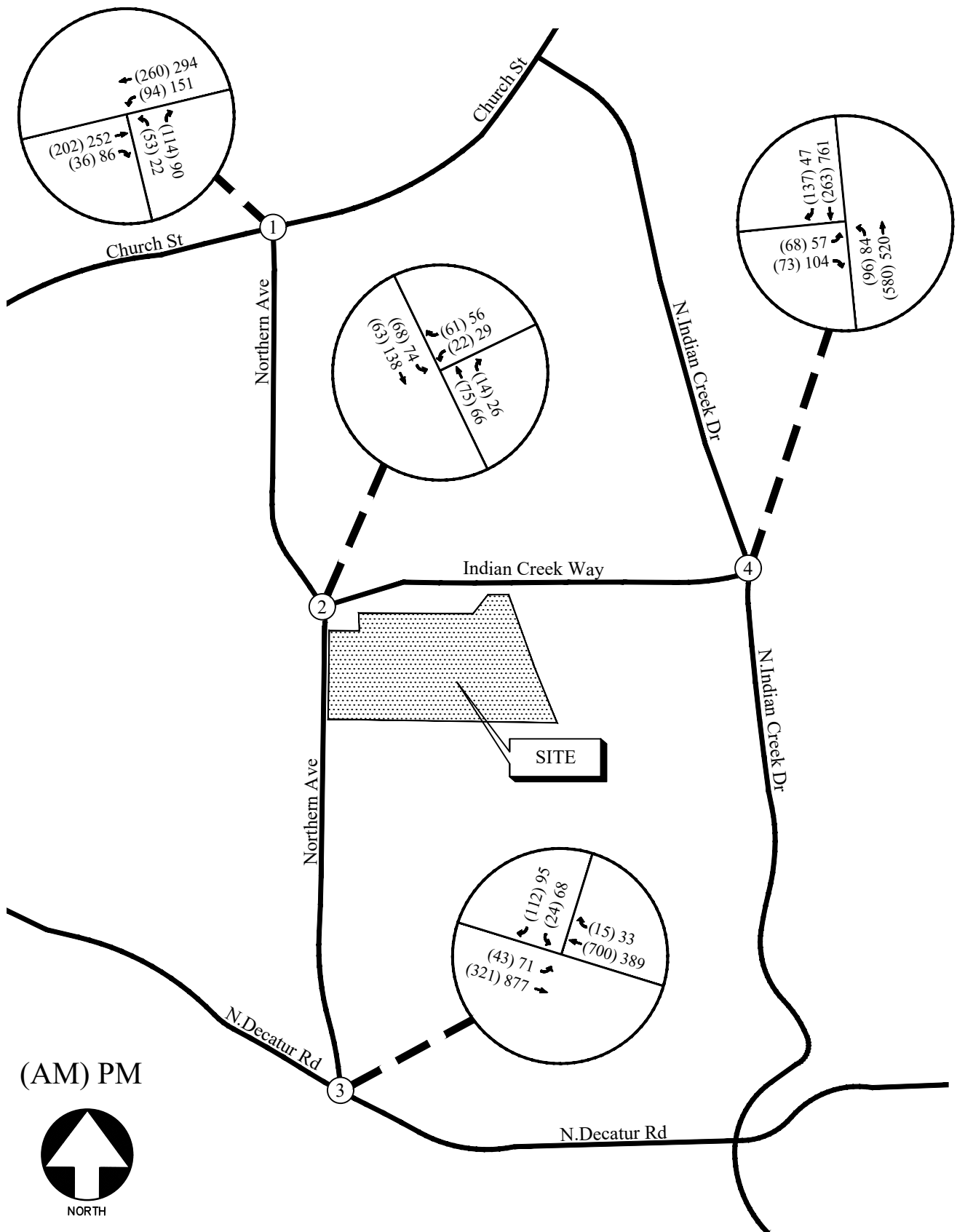

FIGURE 2
A&R Engineering Inc.



ADJUSTED WEEKDAY PEAK-HOUR VOLUMES

FIGURE 3
A&R Engineering Inc.

LEGEND

- Ex  Existing Signed Approach
-  Existing Lane Geometry
- Ex  Existing Traffic Signal

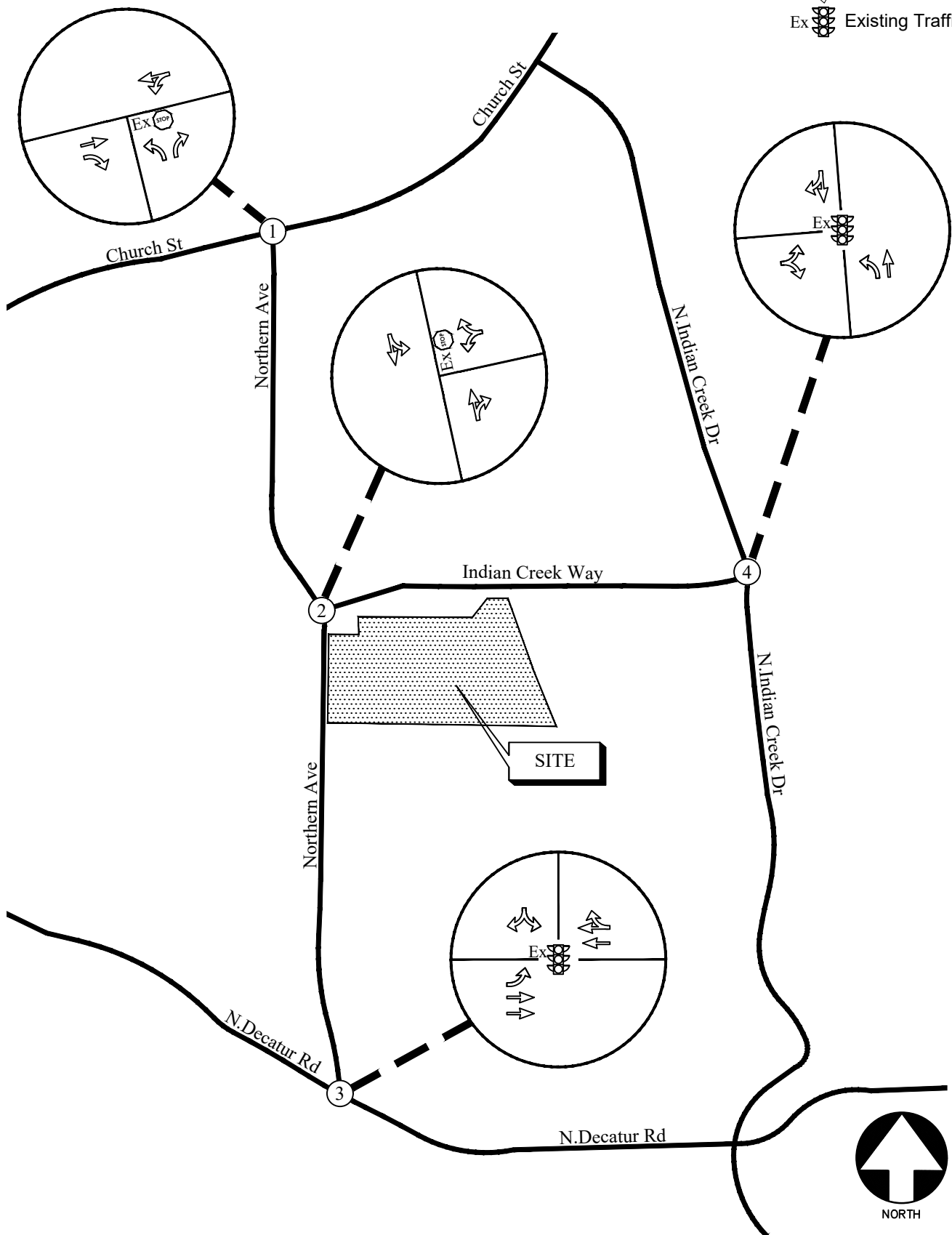

EXISTING TRAFFIC CONTROL AND LANE GEOMETRY

FIGURE 4

A&R Engineering Inc.

5.0 PROPOSED DEVELOPMENT

The proposed residential development will be located in the southeast corner of the intersection of Northern Avenue and Indian Creek Way in DeKalb County, Georgia. The development will consist of:

- 26 Single-family detached housing units and
- 139 Multifamily Low-Rise Housing units

The development proposes access at the following locations:

- Site Driveway 1: Full-access (northern) driveway on Northern Avenue
- Site Driveway 2: Full-access (southern) driveway on Northern Avenue

A site plan is shown in Figure 5.

5.1 Trip Generation

Trip generation estimates for the project were based on the rates and equations published in the 10th edition of the Institute of Transportation Engineers (ITE) Trip Generation report. This reference contains traffic volume count data collected at similar facilities nationwide. The trip generation was based on the following ITE Land Uses: 210 – *Single-Family Detached Housing* and 220 – *Multifamily Housing (Low-Rise)*. The calculated total trip generation for the proposed development is shown in Table 4.

Land Use	Size	AM Peak Hour			PM Peak Hour			24-Hour	
		Enter	Exit	Total	Enter	Exit	Total	Enter	Exit
ITE 210 – Single Family Detached Housing	26 units	6	17	23	18	10	28	150	151
ITE 220 – Multifamily Housing (Low-Rise)	139 units	15	50	65	50	29	79	505	505
Total Site Trips		21	67	88	68	39	107	655	656

5.2 Trip Distribution

The trip distribution describes how traffic arrives and departs from the site. An overall trip distribution was developed for the site based on a review of the existing travel patterns in the area and the locations of major roadways and highways that will serve the development. The site-generated peak hour traffic volumes, shown in Table 4, were assigned to the study area intersections based on this distribution. The outer-leg distribution and AM and PM peak hour new traffic generated by the site are shown in Figure 6.

Figure 5 – Site Plan

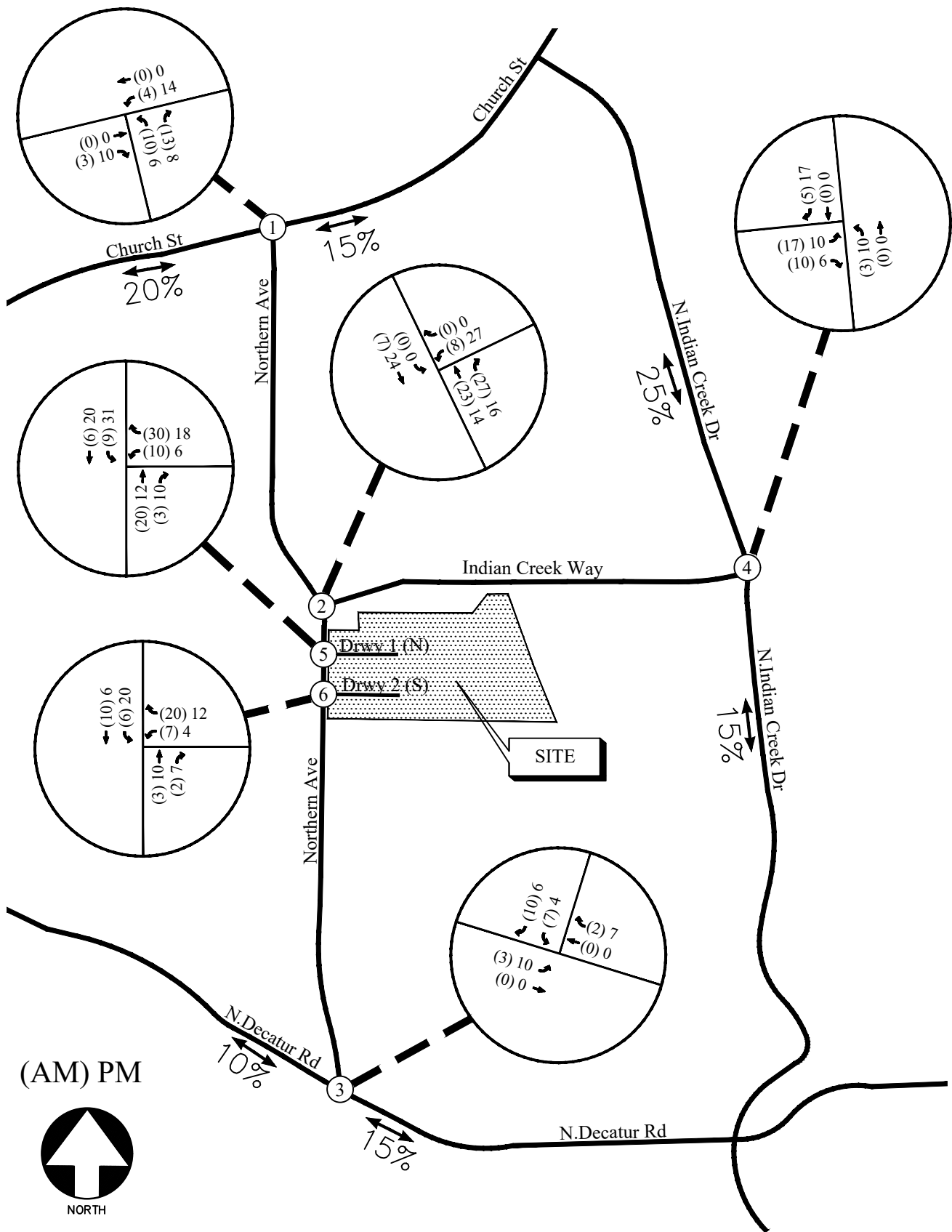

TRIP DISTRIBUTION AND SITE-GENERATED
WEEKDAY PEAK HOUR VOLUMES

FIGURE 6
A&R Engineering Inc.

6.0 FUTURE 2023 TRAFFIC ANALYSIS

The future 2023 traffic operations are analyzed for the “Build” and “No-Build” conditions.

6.1 Future “No-Build” Conditions

The “No-Build” (or background) conditions provide an assessment of how traffic will operate in the study horizon year without the study site being developed as proposed, with projected increases in through traffic volumes due to normal annual growth. The Future “No-Build” volumes consist of the adjusted existing traffic volumes (Figure 3) plus increases for annual growth of through traffic.

6.1.1 Annual Traffic Growth

To evaluate future traffic operations in this area, a projection of normal traffic growth was applied to the adjusted existing volumes. The Georgia Department of Transportation recorded average daily traffic volumes at several locations in the vicinity of the site. Reviewing the growth over the last three years revealed growth of approximately 1% in the area. This growth factor was applied to the adjusted existing traffic volumes (Figure 3) between collector and arterial roadways in order to estimate the future year traffic volumes prior to the addition of site-generated traffic. The resulting Future “No-Build” volumes on the roadway are shown in Figure 7.

6.2 Future “Build” Conditions

The “Build” or development conditions include the estimated background traffic from the “No-Build” conditions plus the added traffic from the proposed development. In order to evaluate future traffic operations in this area, the additional traffic volumes from the site (Figure 6) were added to base traffic volumes (Figure 7) to calculate the future traffic volumes after the construction of the development. These total future “Build” traffic volumes are shown in Figure 8.

6.3 Auxiliary Lane Analysis

Included below are analyses for left-turn lanes and deceleration lanes for all site driveways per GDOT standards. The analysis assumes that the average annual daily traffic (ADT) count on Northern Avenue is less than 6,000 vehicles per day based on the peak hour volumes on all three study intersections on Northern Avenue. The analysis is based on the trip distribution described in Section 5.2 and shown in Figure 6. The 24-hour two-way volume is 1,311 vehicles entering and exiting the site as shown in Trip Generation Table 4.

6.3.1 Left Turn Lane Analysis

For two lane roadways with AADT's less than 6,000 vehicles and a posted speed limit of 35 mph, the daily site generated traffic left-turn movements threshold to warrant a left-turn lane is 300 left-turning vehicles a day. The projected left-turn volumes per day for each driveway are included below.

TABLE 5 - GDOT REQUIREMENTS FOR LEFT TURN LANES				
Intersection	Left-turn traffic (% total entering)	Left-turn Volume (veh/day)	GDOT Threshold (veh/day)	Left-Turn Warrants
Northern Avenue @ Site Driveway 1 (North)	45%	295 (total trips 1311) ÷ 2 × 0.45	300	Not Met
Northern Avenue @ Site Driveway 2 (South)	30%	196 (total trips 1311) ÷ 2 × 0.30 =	300	Not Met

Since the projected number of left-turning vehicles is below the threshold of 300 left turning vehicles at both driveways, left-turn lanes are not warranted at both site driveways on Northern Avenue as per GDOT standards.

6.3.2 Deceleration Turn Lane Analysis

For two lane roadways with AADT's less than 6,000 vehicles and a posted speed limit of 35 mph, the daily site generated right-turn volume threshold to warrant a deceleration lane is 200 right -turning vehicles a day. The projected right-turn volumes per day for each driveway are shown in Table 6.

TABLE 6 - GDOT REQUIREMENTS FOR DECELERATION LANES				
Intersection	Right-turn traffic (% total entering)	Right-turn Volume (veh/day)	GDOT Threshold (veh/day)	Right-Turn Warrants
Northern Avenue @ Site Driveway 1 (North)	15%	98 (total trips 1311) ÷ 2 × 0.15	200	Not Met
Northern Avenue @ Site Driveway 2 (South)	10%	66 (total 1311 trips) ÷ 2 × 0.16	200	Not Met

Since the projected number of right turning vehicles is below the threshold of 200 right turning vehicles, a deceleration lane is not warranted at both the site driveways on Northern Avenue as per GDOT standards.

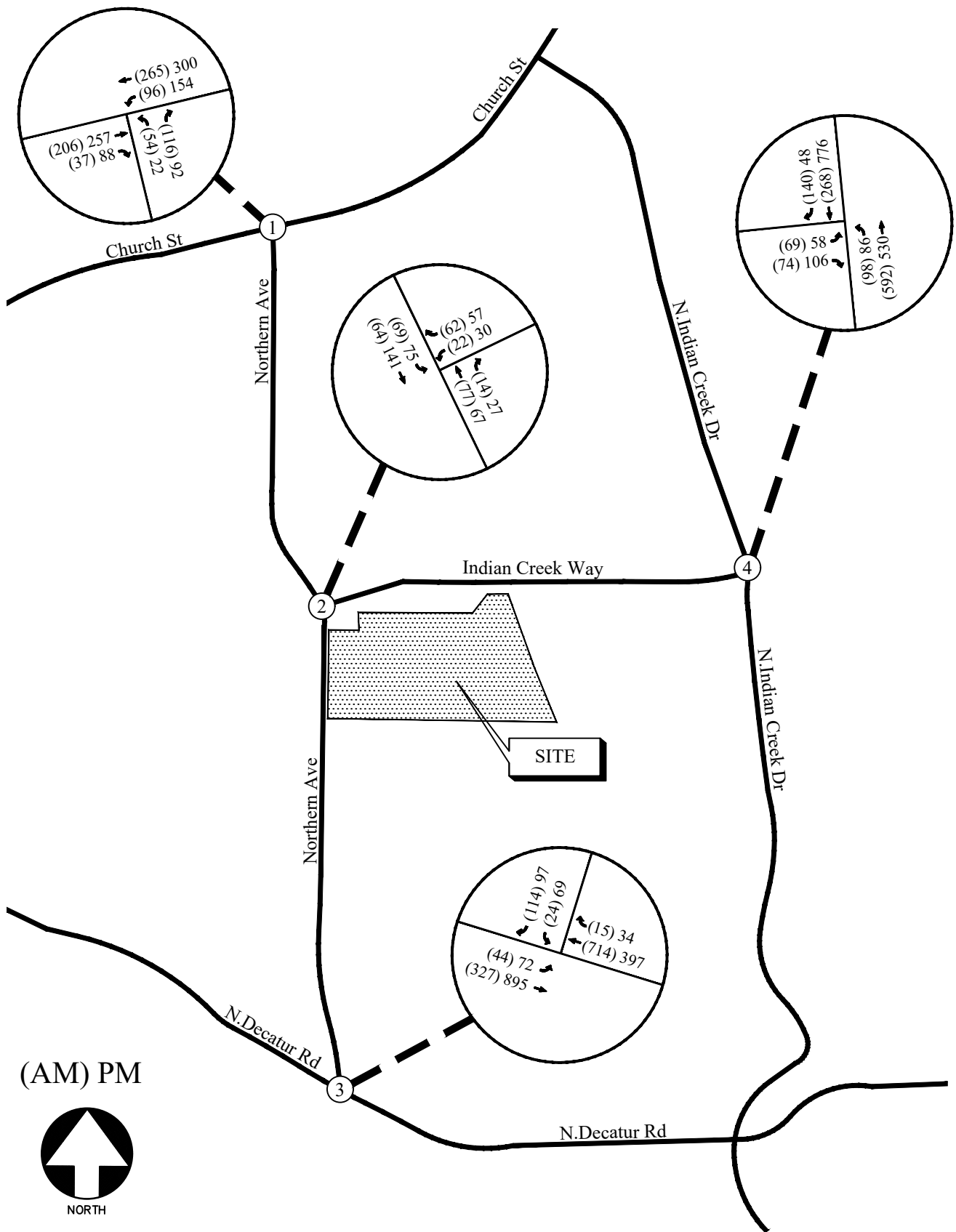

FUTURE (NO-BUILD) WEEKDAY PEAK HOUR VOLUMES

FIGURE 7
A&R Engineering Inc.

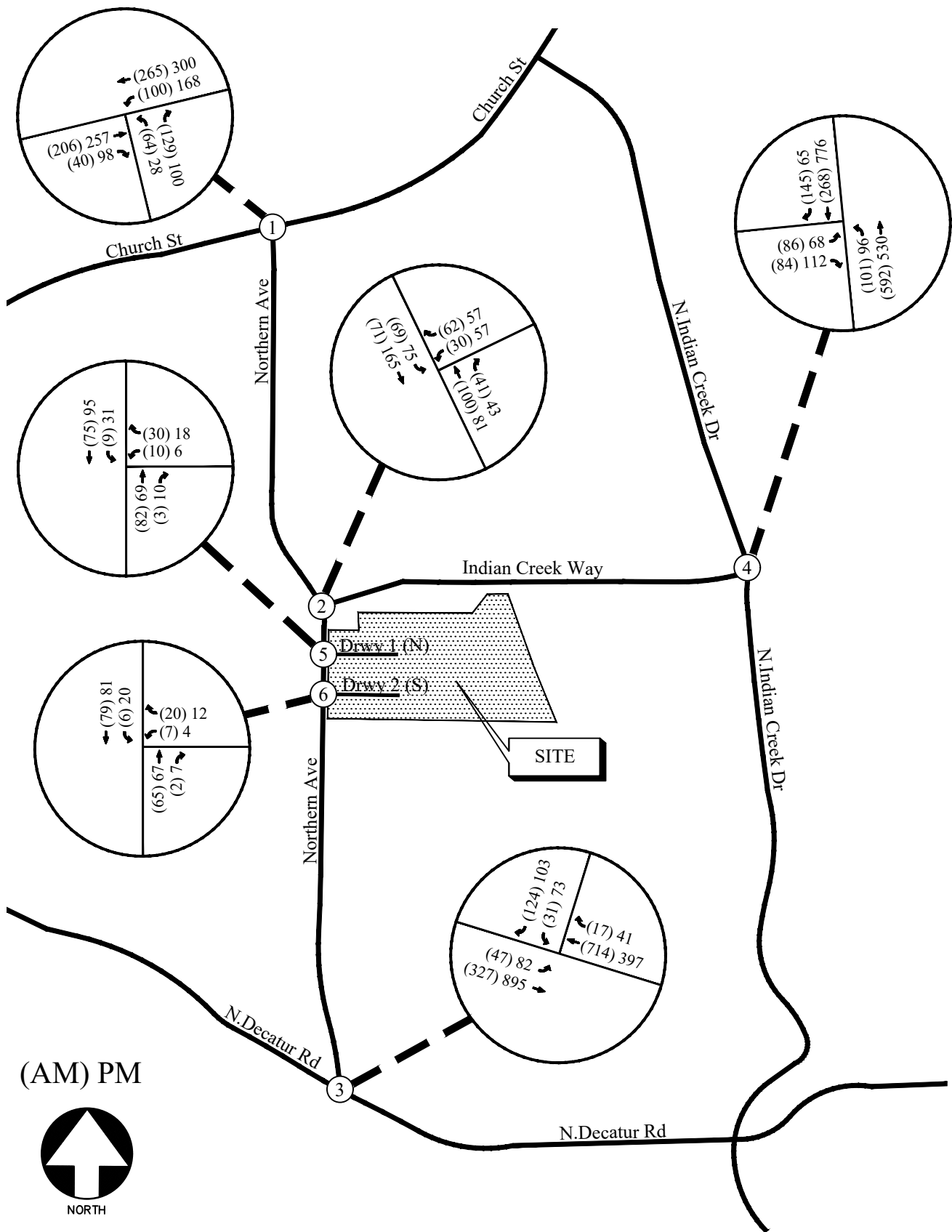

FUTURE (BUILD) WEEKDAY PEAK HOUR VOLUMES

FIGURE 8
A&R Engineering Inc.

6.4 Future Traffic Operations





The future “No-Build” and “Build” traffic operations were analyzed using the volumes in Figure 7 and Figure 8, respectively. The results of the future traffic operations analysis are shown in Table 7.

TABLE 7 – FUTURE INTERSECTION OPERATIONS					
Intersection		Future Condition: LOS (Delay)			
		NO-BUILD		BUILD	
		AM Peak	PM Peak	AM Peak	PM Peak
1	<u>Church Street @ Northern Avenue</u>				
	-Westbound Left -Northbound Approach	A (8.0) B (12.6)	A (8.6) B (12.7)	A (8.1) B (13.0)	A (8.7) B (13.5)
2	<u>Northern Avenue @ Indian Creek Way</u>				
	-Westbound Approach -Southbound Left	A (9.8) A (7.6)	B (10.5) A (7.6)	B (10.4) A (7.7)	B (11.9) A (7.7)
3	<u>N. Decatur Road St @ Northern Avenue</u>	<u>A (2.8)</u>	<u>A (5.1)</u>	<u>A (3.2)</u>	<u>A (5.2)</u>
	-Eastbound Approach	A (1.1)	A (2.0)	A (1.2)	A (2.1)
	-Westbound Approach	A (1.5)	A (1.7)	A (1.6)	A (1.7)
	-Southbound Approach	E (64.8)	E (68.0)	E (65.0)	E (67.4)
4	<u>N. Indian Creek Drive @ Indian Creek Way</u>	<u>B (10.9)</u>	<u>B (11.7)</u>	<u>B (12.4)</u>	<u>B (12.6)</u>
	-Eastbound Approach	E (61.9)	E (61.1)	E (60.5)	E (60.3)
	-Northbound Approach	A (4.5)	A (5.4)	A (5.2)	A (6.1)
	-Southbound Approach	A (3.7)	A (6.5)	A (4.3)	A (7.2)
5	<u>Northern Avenue @ Site Drwy (North)</u>				
	-Westbound Approach -Southbound Left	-	-	A (9.1) A (7.4)	A (9.1) A (7.4)
6	<u>Northern Avenue @ Site Drwy (South)</u>				
	-Westbound Approach -Southbound Left	-	-	A (9.0) A (7.4)	A (9.0) A (7.4)

The future traffic operations analysis results show that all the study intersections will continue to operate at satisfactory levels of service in both the AM and PM peak hours in the future conditions. The impact of site generated traffic on traffic operations on study intersections is insignificant. No improvements are recommended to lane geometry and traffic controls at any study intersection.

Recommendations on traffic control and lane geometry at the site driveways are shown graphically in Figure 9.

LEGEND

- Ex  Existing Signed Approach
-  Proposed Signed Approach
-  Existing Lane Geometry
-  Proposed Lane Geometry
- Ex  Existing Traffic Signal

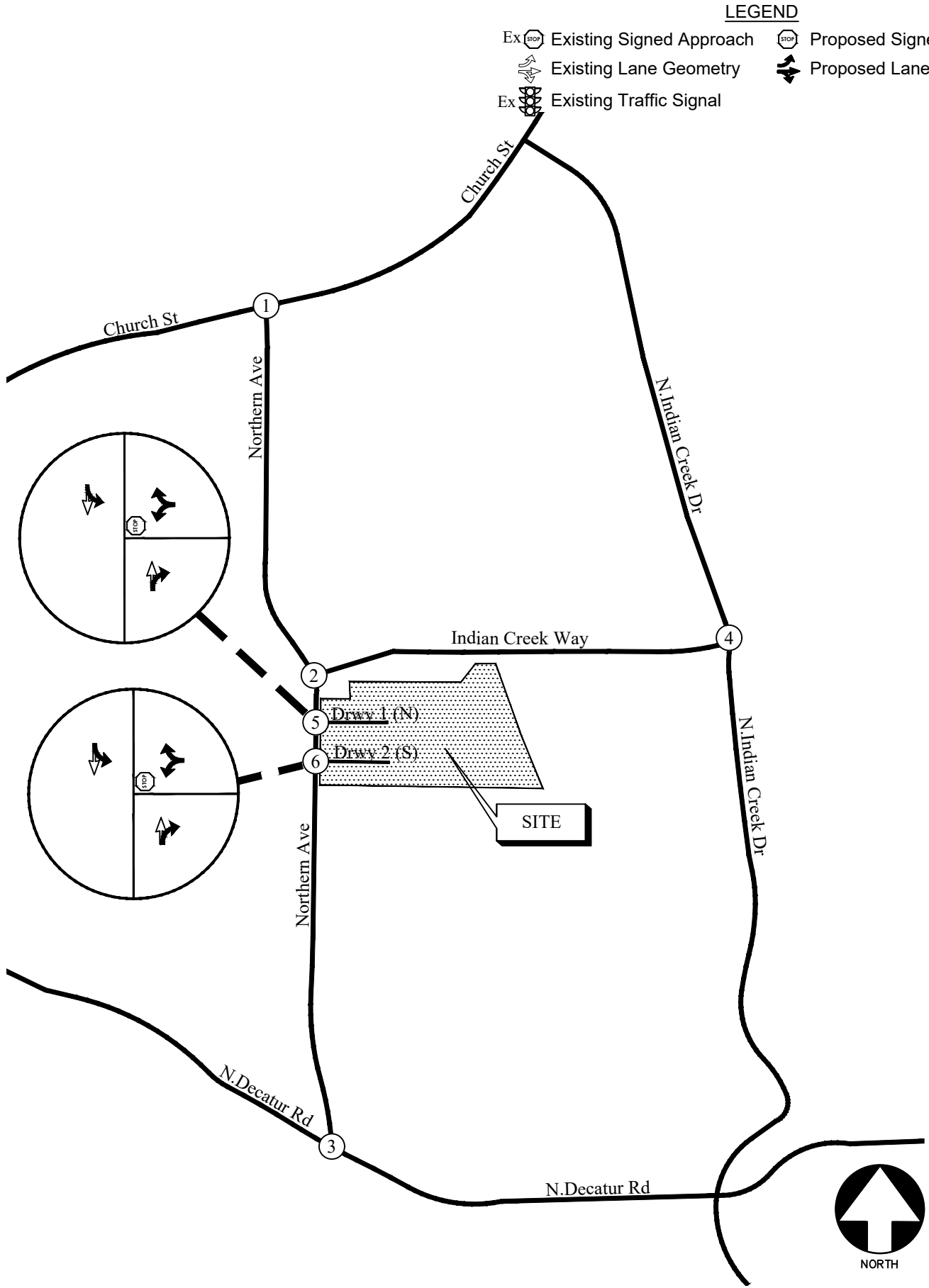

FUTURE TRAFFIC CONTROL AND LANE GEOMETRY

FIGURE 9

A&R Engineering Inc.

7.0 CONCLUSIONS AND RECOMMENDATIONS

Traffic impacts were evaluated for the added traffic from the proposed residential development that will be located in the southeast corner of the intersection of Northern Avenue and Indian Creek Way in DeKalb County, Georgia. The proposed development will consist of:

- 26 Single-family detached housing units and
- 139 Multifamily Low-Rise Housing units

The AM and PM peak hours have been analyzed in this study. In addition to the site driveways, this study includes the evaluation of traffic operations at the intersections of:

- Church Street at Northern Avenue
- Northern Avenue at Indian Creek Way
- N. Decatur Road at Northern Avenue
- N. Indian Creek Drive at Indian Creek Way

7.1 Site Access Configuration

The following access configuration is recommended for the proposed site driveway intersections:

- Site Driveway 1: Full-access (northern) driveway on Northern Avenue
 - To consist of one entering and one exiting lane. The westbound (driveway) approach to have a shared left/right-turn lane for exiting traffic.
 - To be un-signalized with a STOP sign on the westbound approach.
 - A left turn lane is not warranted based on GDOT standards (See Section 6.3.1).
 - A deceleration lane is not warranted based on GDOT standards (See Section 6.3.2).
- Site Driveway 2: Full-access (southern) driveway on Northern Avenue
 - To consist of one entering and one exiting lane. The westbound (driveway) approach to have a shared left/right-turn lane for exiting traffic.
 - To be un-signalized with a STOP sign on the westbound approach.
 - A left turn lane is not warranted based on GDOT standards (See Section 6.3.1).
 - A deceleration lane is not warranted based on GDOT standards (See Section 6.3.2).

The future traffic operations analysis results show that all the study intersections will continue to operate at satisfactory levels of service in both the AM and PM peak hours. The impact of site generated traffic on traffic operations on study intersections is insignificant. No improvements are recommended to lane geometry and traffic controls at any study intersection.

Appendix

- Existing Intersection Traffic Counts
- Linear Regression of Daily Traffic.....
- Existing Intersection Analysis.....
- Future “No-Build” Intersection Analysis
- Future “Build” Intersection Analysis.....
- Traffic Volume Worksheets

EXISTING INTERSECTION TRAFFIC COUNTS

A & R Engineering, In

2160 Kingston Court, Suite 'O',
Marietta, GA 30067

TMC Data
Northern Ave @ Church St
7-9 am | 4-6 pm

File Name : 20210005
Site Code : 20210005
Start Date : 1/7/2021
Page No : 1

Groups Printed- Cars,Buses & Trucks

Start Time	Northern Ave Northbound				Southbound				Church St Eastbound				Church St Westbound				Int. Total
	Left	Thru	Right	App. Total	Left	Thru	Right	App. Total	Left	Thru	Right	App. Total	Left	Thru	Right	App. Total	
07:00 AM	3	0	16	19	0	0	0	0	0	16	5	21	13	36	0	49	89
07:15 AM	11	0	17	28	0	0	0	0	0	22	6	28	15	44	0	59	115
07:30 AM	8	0	16	24	0	0	0	0	0	21	7	28	10	38	0	48	100
07:45 AM	11	0	15	26	0	0	0	0	0	42	6	48	22	28	0	50	124
Total	33	0	64	97	0	0	0	0	0	101	24	125	60	146	0	206	428
08:00 AM	4	0	15	19	0	0	0	0	0	23	8	31	14	35	0	49	99
08:15 AM	8	0	18	26	0	0	0	0	0	24	3	27	11	53	0	64	117
08:30 AM	8	0	19	27	0	0	0	0	0	30	4	34	8	37	0	45	106
08:45 AM	8	0	20	28	0	0	0	0	0	31	2	33	16	35	0	51	112
Total	28	0	72	100	0	0	0	0	0	108	17	125	49	160	0	209	434
*** BREAK ***																	
04:00 PM	11	0	31	42	0	0	0	0	0	75	7	82	42	48	0	90	214
04:15 PM	9	0	22	31	0	0	0	0	0	60	6	66	43	62	0	105	202
04:30 PM	4	0	23	27	0	0	0	0	0	46	16	62	31	53	0	84	173
04:45 PM	4	0	15	19	0	0	0	0	0	48	9	57	36	51	0	87	163
Total	28	0	91	119	0	0	0	0	0	229	38	267	152	214	0	366	752
05:00 PM	5	0	17	22	0	0	0	0	0	49	25	74	35	83	0	118	214
05:15 PM	4	0	24	28	0	0	0	0	0	57	13	70	24	55	0	79	177
05:30 PM	5	0	16	21	0	0	0	0	0	60	21	81	34	63	0	97	199
05:45 PM	5	0	21	26	0	0	0	0	0	53	16	69	38	55	0	93	188
Total	19	0	78	97	0	0	0	0	0	219	75	294	131	256	0	387	778
Grand Total	108	0	305	413	0	0	0	0	0	657	154	811	392	776	0	1168	2392
Apprch %	26.2	0	73.8		0	0	0		0	81	19		33.6	66.4	0		
Total %	4.5	0	12.8	17.3	0	0	0	0	0	27.5	6.4	33.9	16.4	32.4	0	48.8	

A & R Engineering, In

2160 Kingston Court, Suite 'O',
Marietta, GA 30067

TMC Data
Northern Ave @ Church St
7-9 am | 4-6 pm

File Name : 20210005
Site Code : 20210005
Start Date : 1/7/2021
Page No : 2

Start Time	Northern Ave Northbound				Southbound				Church St Eastbound				Church St Westbound				Int. Total
	Left	Thru	Right	App. Total	Left	Thru	Right	App. Total	Left	Thru	Right	App. Total	Left	Thru	Right	App. Total	
Peak Hour Analysis From 07:00 AM to 08:45 AM - Peak 1 of 1																	
Peak Hour for Entire Intersection Begins at 07:45 AM																	
07:45 AM	11	0	15	26	0	0	0	0	0	42	6	48	22	28	0	50	124
08:00 AM	4	0	15	19	0	0	0	0	0	23	8	31	14	35	0	49	99
08:15 AM	8	0	18	26	0	0	0	0	0	24	3	27	11	53	0	64	117
08:30 AM	8	0	19	27	0	0	0	0	0	30	4	34	8	37	0	45	106
Total Volume	31	0	67	98	0	0	0	0	0	119	21	140	55	153	0	208	446
% App. Total	31.6	0	68.4		0	0	0			85	15		26.4	73.6	0		
PHF	.705	.000	.882	.907	.000	.000	.000	.000	.000	.708	.656	.729	.625	.722	.000	.813	.899

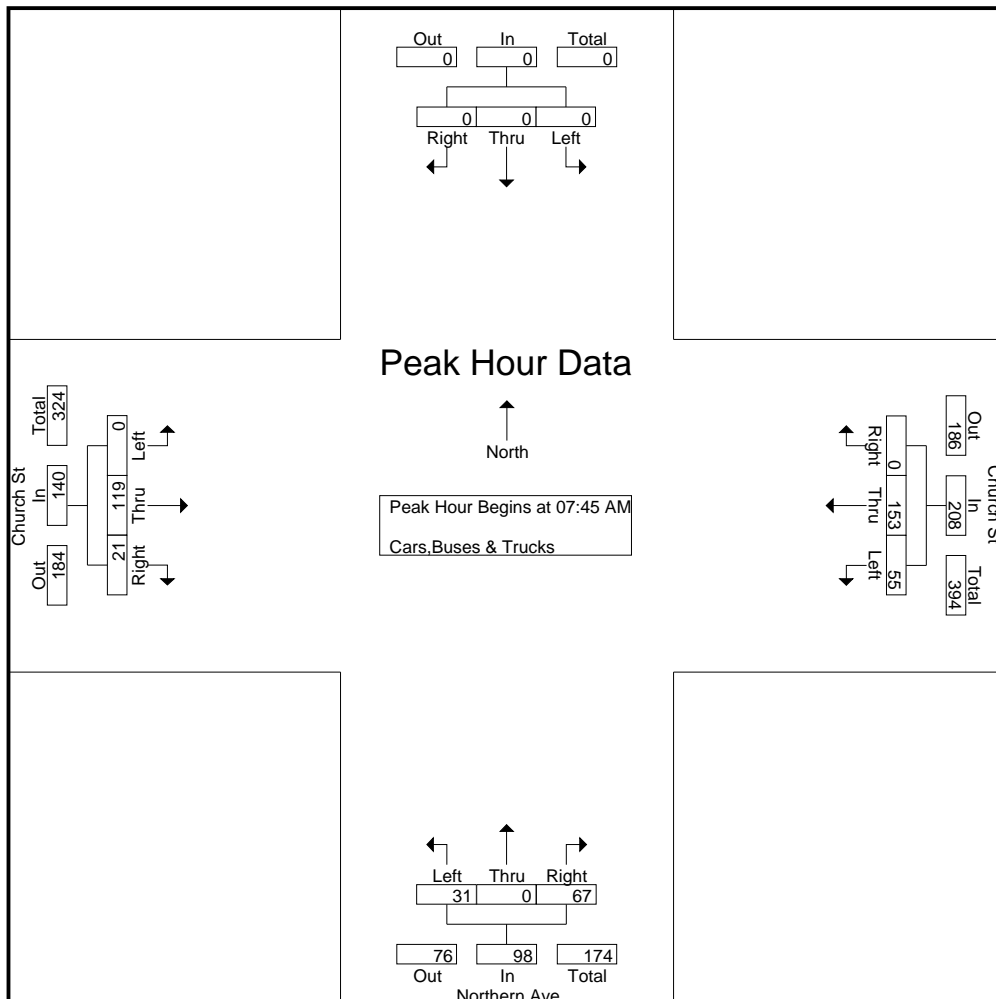

A & R Engineering, In

2160 Kingston Court, Suite 'O',
Marietta, GA 30067

TMC Data
Northern Ave @ Church St
7-9 am | 4-6 pm

File Name : 20210005
Site Code : 20210005
Start Date : 1/7/2021
Page No : 3

Start Time	Northern Ave Northbound				Southbound				Church St Eastbound				Church St Westbound				Int. Total
	Left	Thru	Right	App. Total	Left	Thru	Right	App. Total	Left	Thru	Right	App. Total	Left	Thru	Right	App. Total	
Peak Hour Analysis From 04:00 PM to 05:45 PM - Peak 1 of 1																	
Peak Hour for Entire Intersection Begins at 05:00 PM																	
05:00 PM	5	0	17	22	0	0	0	0	0	49	25	74	35	83	0	118	214
05:15 PM	4	0	24	28	0	0	0	0	0	57	13	70	24	55	0	79	177
05:30 PM	5	0	16	21	0	0	0	0	0	60	21	81	34	63	0	97	199
05:45 PM	5	0	21	26	0	0	0	0	0	53	16	69	38	55	0	93	188
Total Volume	19	0	78	97	0	0	0	0	0	219	75	294	131	256	0	387	778
% App. Total	19.6	0	80.4		0	0	0		0	74.5	25.5		33.9	66.1	0		
PHF	.950	.000	.813	.866	.000	.000	.000	.000	.000	.913	.750	.907	.862	.771	.000	.820	.909

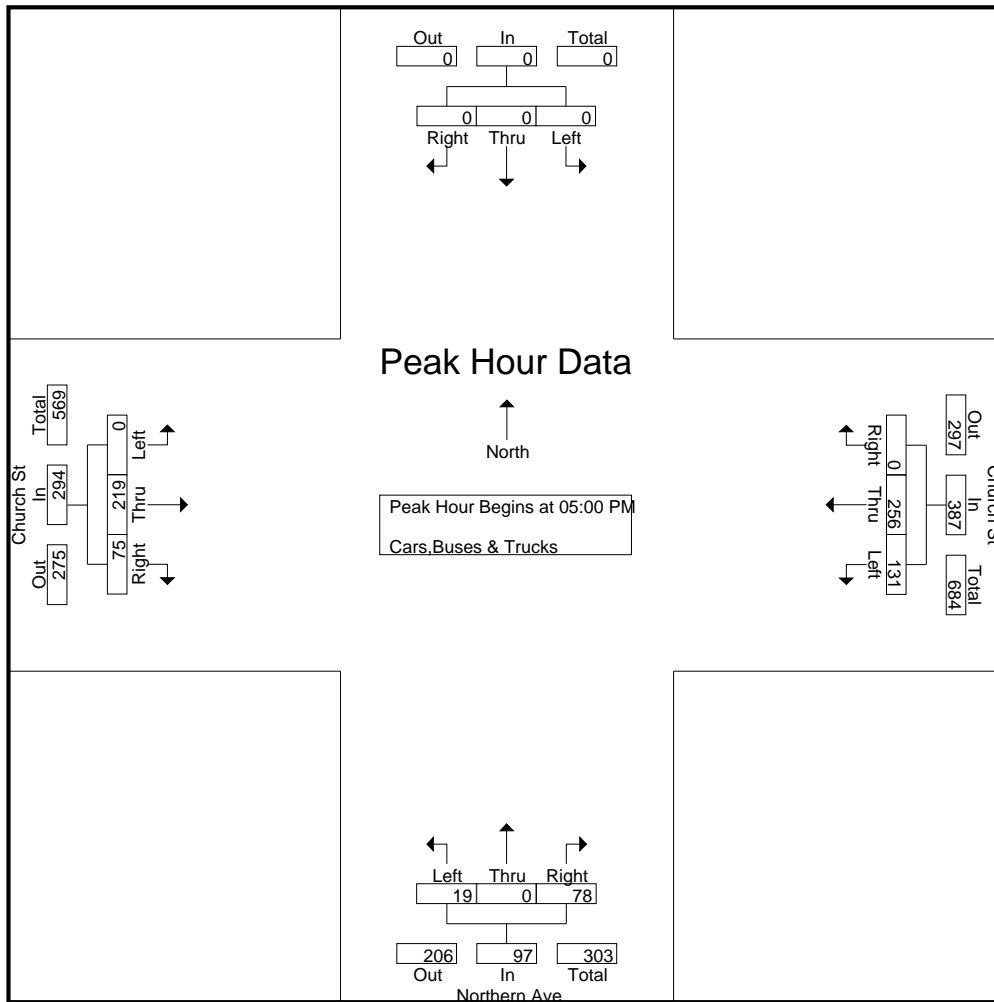

A & R Engineering, In

2160 Kingston Court, Suite 'O',
Marietta, GA 30067

TMC Data
Northern Avenue @ Indian Creek Way
7-9 am | 4-6 pm

File Name : 20210006
Site Code : 20210006
Start Date : 1/7/2021
Page No : 1

Groups Printed- Cars,Buses & Trucks

Start Time	Northern Ave Northbound				Northern Ave Southbound				Eastbound				Indian Creek Way Westbound				Int. Total
	Left	Thru	Right	App. Total	Left	Thru	Right	App. Total	Left	Thru	Right	App. Total	Left	Thru	Right	App. Total	
07:00 AM	0	9	0	9	11	11	0	22	0	0	0	0	4	0	5	9	40
07:15 AM	0	16	2	18	8	9	0	17	0	0	0	0	5	0	12	17	52
07:30 AM	0	7	1	8	10	9	0	19	0	0	0	0	1	0	9	10	37
07:45 AM	0	10	2	12	14	9	0	23	0	0	0	0	3	0	7	10	45
Total	0	42	5	47	43	38	0	81	0	0	0	0	13	0	33	46	174
08:00 AM	0	11	3	14	8	10	0	18	0	0	0	0	4	0	8	12	44
08:15 AM	0	14	2	16	1	11	0	12	0	0	0	0	2	0	8	10	38
08:30 AM	0	12	1	13	1	15	0	16	0	0	0	0	7	0	6	13	42
08:45 AM	0	11	2	13	6	11	0	17	0	0	0	0	4	0	11	15	45
Total	0	48	8	56	16	47	0	63	0	0	0	0	17	0	33	50	169
*** BREAK ***																	
04:00 PM	0	18	5	23	14	33	0	47	0	0	0	0	6	0	14	20	90
04:15 PM	0	18	3	21	15	35	0	50	0	0	0	0	2	0	9	11	82
04:30 PM	0	17	6	23	12	23	0	35	0	0	0	0	6	0	6	12	70
04:45 PM	0	11	3	14	16	30	0	46	0	0	0	0	7	0	11	18	78
Total	0	64	17	81	57	121	0	178	0	0	0	0	21	0	40	61	320
05:00 PM	0	16	5	21	15	29	0	44	0	0	0	0	8	0	14	22	87
05:15 PM	0	14	2	16	16	26	0	42	0	0	0	0	5	0	12	17	75
05:30 PM	0	16	13	29	17	35	0	52	0	0	0	0	5	0	12	17	98
05:45 PM	0	19	2	21	18	24	0	42	0	0	0	0	4	0	10	14	77
Total	0	65	22	87	66	114	0	180	0	0	0	0	22	0	48	70	337
Grand Total	0	219	52	271	182	320	0	502	0	0	0	0	73	0	154	227	1000
Apprch %	0	80.8	19.2		36.3	63.7	0		0	0	0	0	32.2	0	67.8		
Total %	0	21.9	5.2	27.1	18.2	32	0	50.2	0	0	0	0	7.3	0	15.4	22.7	

A & R Engineering, In

2160 Kingston Court, Suite 'O',
Marietta, GA 30067

TMC Data
Northern Avenue @ Indian Creek Way
7-9 am | 4-6 pm

File Name : 20210006
Site Code : 20210006
Start Date : 1/7/2021
Page No : 2

Start Time	Northern Ave Northbound				Northern Ave Southbound				Eastbound				Indian Creek Way Westbound				Int. Total
	Left	Thru	Right	App. Total	Left	Thru	Right	App. Total	Left	Thru	Right	App. Total	Left	Thru	Right	App. Total	
Peak Hour Analysis From 07:00 AM to 11:45 AM - Peak 1 of 1																	
Peak Hour for Entire Intersection Begins at 07:15 AM																	
07:15 AM	0	16	2	18	8	9	0	17	0	0	0	0	5	0	12	17	52
07:30 AM	0	7	1	8	10	9	0	19	0	0	0	0	1	0	9	10	37
07:45 AM	0	10	2	12	14	9	0	23	0	0	0	0	3	0	7	10	45
08:00 AM	0	11	3	14	8	10	0	18	0	0	0	0	4	0	8	12	44
Total Volume	0	44	8	52	40	37	0	77	0	0	0	0	13	0	36	49	178
% App. Total	0	84.6	15.4		51.9	48.1	0		0	0	0		26.5	0	73.5		
PHF	.000	.688	.667	.722	.714	.925	.000	.837	.000	.000	.000	.000	.650	.000	.750	.721	.856

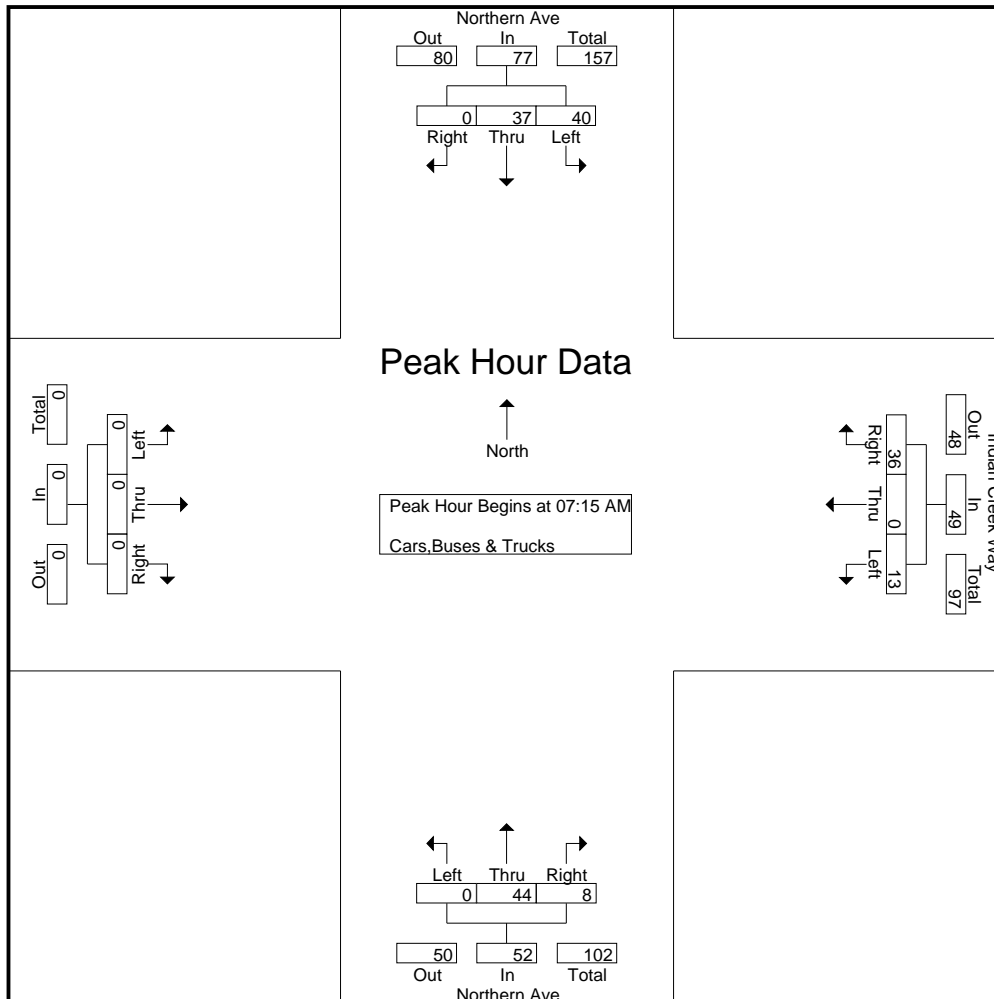

A & R Engineering, In

2160 Kingston Court, Suite 'O',
Marietta, GA 30067

TMC Data
Northern Avenue @ Indian Creek Way
7-9 am | 4-6 pm

File Name : 20210006
Site Code : 20210006
Start Date : 1/7/2021
Page No : 3

Start Time	Northern Ave Northbound				Northern Ave Southbound				Eastbound				Indian Creek Way Westbound				Int. Total
	Left	Thru	Right	App. Total	Left	Thru	Right	App. Total	Left	Thru	Right	App. Total	Left	Thru	Right	App. Total	
Peak Hour Analysis From 04:00 PM to 05:45 PM - Peak 1 of 1																	
Peak Hour for Entire Intersection Begins at 04:45 PM																	
04:45 PM	0	11	3	14	16	30	0	46	0	0	0	0	7	0	11	18	78
05:00 PM	0	16	5	21	15	29	0	44	0	0	0	0	8	0	14	22	87
05:15 PM	0	14	2	16	16	26	0	42	0	0	0	0	5	0	12	17	75
05:30 PM	0	16	13	29	17	35	0	52	0	0	0	0	5	0	12	17	98
Total Volume	0	57	23	80	64	120	0	184	0	0	0	0	25	0	49	74	338
% App. Total	0	71.2	28.8		34.8	65.2	0		0	0	0		33.8	0	66.2		
PHF	.000	.891	.442	.690	.941	.857	.000	.885	.000	.000	.000	.000	.781	.000	.875	.841	.862

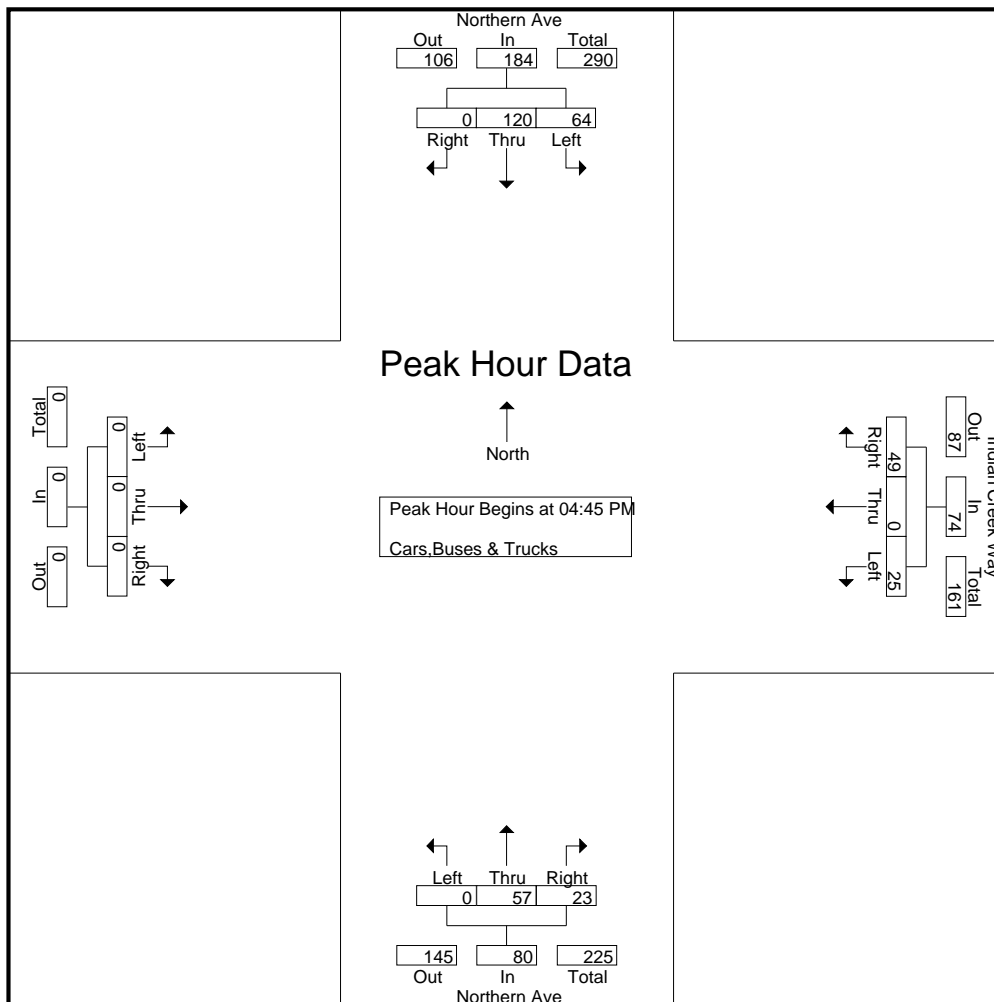

A & R Engineering, In

2160 Kingston Court, Suite 'O',
Marietta, GA 30067

TMC Data
Indian Creek Way @
North Indian Creek Dr
7-9 am | 4-6 pm

File Name : 20210007
Site Code : 20210007
Start Date : 1/7/2021
Page No : 1

Groups Printed- Cars,Buses & Trucks

Start Time	N Indian Creek Dr Northbound				N Indian Creek Dr Southbound				Indian Creek Way Eastbound				Westbound				Int. Total
	Left	Thru	Right	App. Total	Left	Thru	Right	App. Total	Left	Thru	Right	App. Total	Left	Thru	Right	App. Total	
07:00 AM	2	31	0	33	0	17	2	19	5	0	4	9	0	0	0	0	61
07:15 AM	10	34	0	44	0	28	4	32	4	0	5	9	0	0	0	0	85
07:30 AM	8	40	0	48	0	36	1	37	6	0	7	13	0	0	0	0	98
07:45 AM	11	42	0	53	0	36	5	41	4	0	12	16	0	0	0	0	110
Total	31	147	0	178	0	117	12	129	19	0	28	47	0	0	0	0	354
08:00 AM	7	52	0	59	0	37	8	45	6	0	9	15	0	0	0	0	119
08:15 AM	10	45	0	55	0	48	3	51	3	0	12	15	0	0	0	0	121
08:30 AM	5	46	0	51	0	49	4	53	4	0	9	13	0	0	0	0	117
08:45 AM	6	45	0	51	0	52	4	56	5	0	14	19	0	0	0	0	126
Total	28	188	0	216	0	186	19	205	18	0	44	62	0	0	0	0	483
*** BREAK ***																	
04:00 PM	17	96	0	113	0	136	13	149	15	0	20	35	0	0	0	0	297
04:15 PM	25	105	0	130	0	126	14	140	12	0	22	34	0	0	0	0	304
04:30 PM	13	110	0	123	0	139	11	150	5	0	26	31	0	0	0	0	304
04:45 PM	21	106	0	127	0	123	17	140	6	0	19	25	0	0	0	0	292
Total	76	417	0	493	0	524	55	579	38	0	87	125	0	0	0	0	1197
05:00 PM	15	121	0	136	0	120	12	132	17	0	20	37	0	0	0	0	305
05:15 PM	20	93	0	113	0	116	11	127	9	0	21	30	0	0	0	0	270
05:30 PM	15	109	0	124	0	111	11	122	8	0	23	31	0	0	0	0	277
05:45 PM	25	105	0	130	0	99	12	111	15	0	19	34	0	0	0	0	275
Total	75	428	0	503	0	446	46	492	49	0	83	132	0	0	0	0	1127
Grand Total	210	1180	0	1390	0	1273	132	1405	124	0	242	366	0	0	0	0	3161
Apprch %	15.1	84.9	0		0	90.6	9.4		33.9	0	66.1		0	0	0		
Total %	6.6	37.3	0	4.4	0	40.3	4.2	44.4	3.9	0	7.7	11.6	0	0	0	0	

A & R Engineering, In

2160 Kingston Court, Suite 'O',
Marietta, GA 30067

TMC Data
Indian Creek Way @
North Indian Creek Dr
7-9 am | 4-6 pm

File Name : 20210007
Site Code : 20210007
Start Date : 1/7/2021
Page No : 2

Start Time	N Indian Creek Dr Northbound				N Indian Creek Dr Southbound				Indian Creek Way Eastbound				Westbound				Int. Total
	Left	Thru	Right	App. Total	Left	Thru	Right	App. Total	Left	Thru	Right	App. Total	Left	Thru	Right	App. Total	
Peak Hour Analysis From 07:00 AM to 08:45 AM - Peak 1 of 1																	
Peak Hour for Entire Intersection Begins at 08:00 AM																	
08:00 AM	7	52	0	59	0	37	8	45	6	0	9	15	0	0	0	0	119
08:15 AM	10	45	0	55	0	48	3	51	3	0	12	15	0	0	0	0	121
08:30 AM	5	46	0	51	0	49	4	53	4	0	9	13	0	0	0	0	117
08:45 AM	6	45	0	51	0	52	4	56	5	0	14	19	0	0	0	0	126
Total Volume	28	188	0	216	0	186	19	205	18	0	44	62	0	0	0	0	483
% App. Total	13	87	0		0	90.7	9.3		29	0	71		0	0	0		
PHF	.700	.904	.000	.915	.000	.894	.594	.915	.750	.000	.786	.816	.000	.000	.000	.000	.958

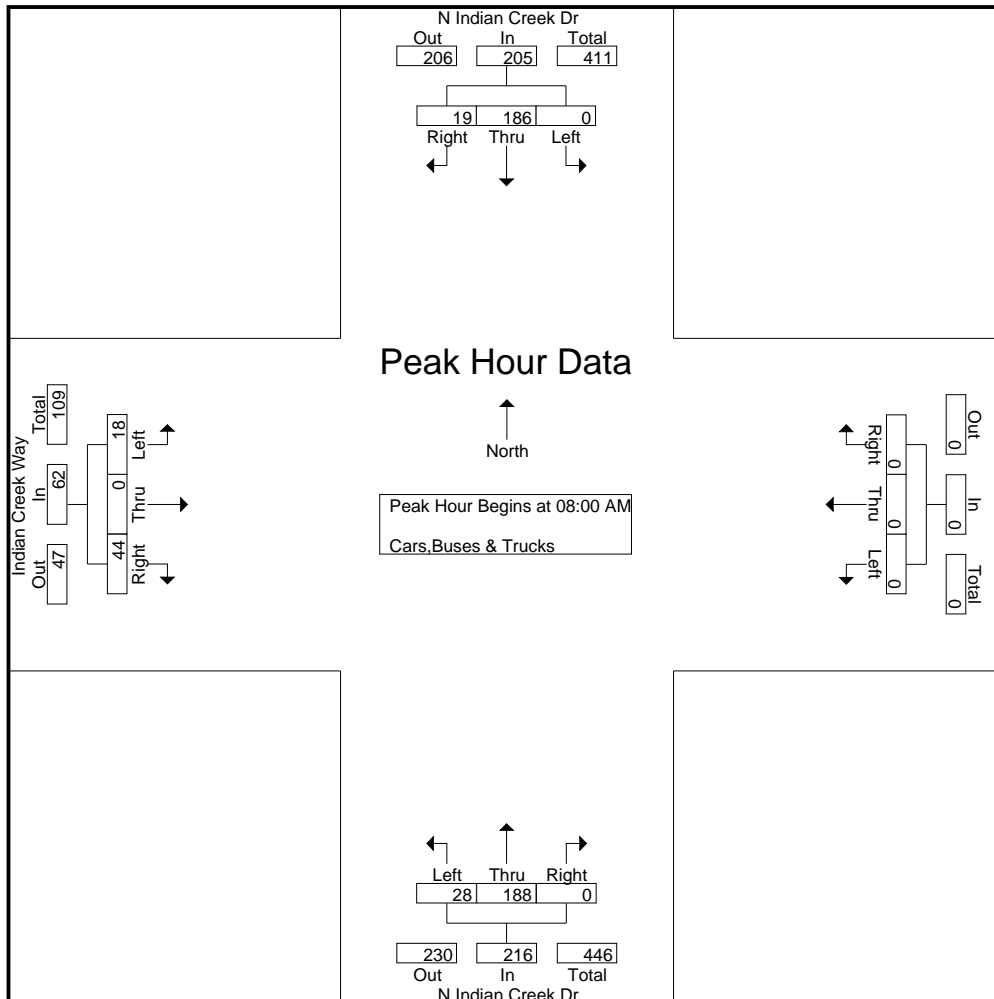

A & R Engineering, In

2160 Kingston Court, Suite 'O',
Marietta, GA 30067

TMC Data
Indian Creek Way @
North Indian Creek Dr
7-9 am | 4-6 pm

File Name : 20210007
Site Code : 20210007
Start Date : 1/7/2021
Page No : 3

Start Time	N Indian Creek Dr Northbound				N Indian Creek Dr Southbound				Indian Creek Way Eastbound				Westbound				Int. Total
	Left	Thru	Right	App. Total	Left	Thru	Right	App. Total	Left	Thru	Right	App. Total	Left	Thru	Right	App. Total	
Peak Hour Analysis From 04:00 PM to 05:45 PM - Peak 1 of 1																	
Peak Hour for Entire Intersection Begins at 04:15 PM																	
04:15 PM	25	105	0	130	0	126	14	140	12	0	22	34	0	0	0	0	304
04:30 PM	13	110	0	123	0	139	11	150	5	0	26	31	0	0	0	0	304
04:45 PM	21	106	0	127	0	123	17	140	6	0	19	25	0	0	0	0	292
05:00 PM	15	121	0	136	0	120	12	132	17	0	20	37	0	0	0	0	305
Total Volume	74	442	0	516	0	508	54	562	40	0	87	127	0	0	0	0	1205
% App. Total	14.3	85.7	0		0	90.4	9.6		31.5	0	68.5		0	0	0		
PHF	.740	.913	.000	.949	.000	.914	.794	.937	.588	.000	.837	.858	.000	.000	.000	.000	.988

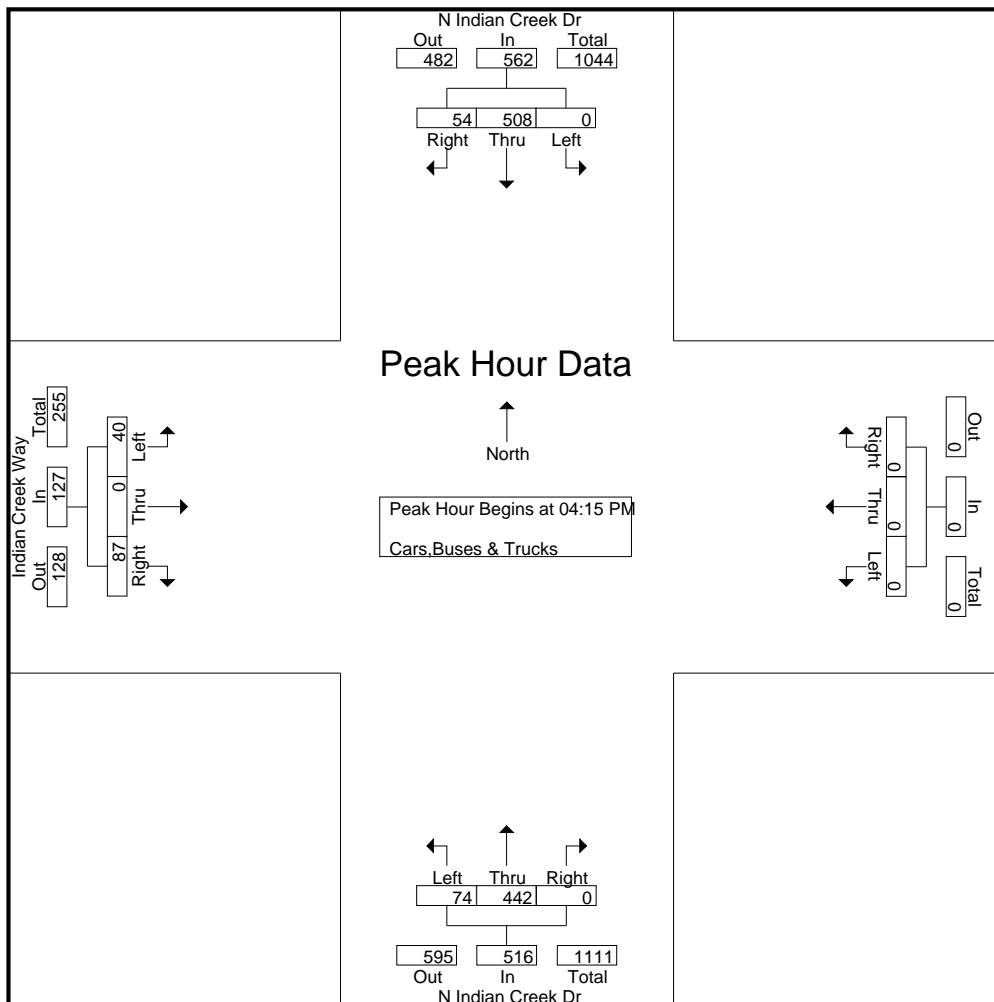

A & R Engineering, In

2160 Kingston Court, Suite 'O',
Marietta, GA 30067

TMC Data
Northern Ave @ North Decatur Rd
7-9 am | 4-6 pm

File Name : 20210008
Site Code : 20210008
Start Date : 1/7/2021
Page No : 1

Groups Printed- Cars,Buses & Trucks

Start Time	Northbound				Northern Ave Southbound				N Decatur Rd Eastbound				N Decatur Rd Westbound				Int. Total
	Left	Thru	Right	App. Total	Left	Thru	Right	App. Total	Left	Thru	Right	App. Total	Left	Thru	Right	App. Total	
07:00 AM	0	0	0	0	4	0	9	13	5	35	0	40	0	98	4	102	155
07:15 AM	0	0	0	0	3	0	10	13	9	22	0	31	0	93	2	95	139
07:30 AM	0	0	0	0	7	0	10	17	7	32	0	39	0	98	3	101	157
07:45 AM	0	0	0	0	3	0	9	12	5	48	0	53	0	124	1	125	190
Total	0	0	0	0	17	0	38	55	26	137	0	163	0	413	10	423	641
08:00 AM	0	0	0	0	2	0	13	15	5	48	0	53	0	108	2	110	178
08:15 AM	0	0	0	0	3	0	17	20	5	46	0	51	0	88	2	90	161
08:30 AM	0	0	0	0	6	0	27	33	10	47	0	57	0	92	4	96	186
08:45 AM	0	0	0	0	6	0	13	19	6	55	0	61	0	103	5	108	188
Total	0	0	0	0	17	0	70	87	26	196	0	222	0	391	13	404	713
*** BREAK ***																	
04:00 PM	0	0	0	0	10	0	26	36	13	169	0	182	0	83	6	89	307
04:15 PM	0	0	0	0	15	0	16	31	17	210	0	227	0	86	6	92	350
04:30 PM	0	0	0	0	14	0	21	35	14	172	0	186	0	86	5	91	312
04:45 PM	0	0	0	0	15	0	25	40	16	200	0	216	0	82	6	88	344
Total	0	0	0	0	54	0	88	142	60	751	0	811	0	337	23	360	1313
05:00 PM	0	0	0	0	15	0	21	36	15	181	0	196	0	84	12	96	328
05:15 PM	0	0	0	0	9	0	26	35	18	199	0	217	0	77	8	85	337
05:30 PM	0	0	0	0	11	0	24	35	24	174	0	198	0	75	15	90	323
05:45 PM	0	0	0	0	7	0	16	23	13	176	0	189	0	83	7	90	302
Total	0	0	0	0	42	0	87	129	70	730	0	800	0	319	42	361	1290
Grand Total	0	0	0	0	130	0	283	413	182	1814	0	1996	0	1460	88	1548	3957
Apprch %	0	0	0	0	31.5	0	68.5	10.4	9.1	90.9	0	50.4	0	94.3	5.7	39.1	
Total %	0	0	0	0	3.3	0	7.2	10.4	4.6	45.8	0	50.4	0	36.9	2.2	39.1	

A & R Engineering, In

2160 Kingston Court, Suite 'O',
Marietta, GA 30067

TMC Data
Northern Ave @ North Decatur Rd
7-9 am | 4-6 pm

File Name : 20210008
Site Code : 20210008
Start Date : 1/7/2021
Page No : 2

Start Time	Northbound				Northern Ave Southbound				N Decatur Rd Eastbound				N Decatur Rd Westbound				Int. Total
	Left	Thru	Right	App. Total	Left	Thru	Right	App. Total	Left	Thru	Right	App. Total	Left	Thru	Right	App. Total	
Peak Hour Analysis From 07:00 AM to 08:45 AM - Peak 1 of 1																	
Peak Hour for Entire Intersection Begins at 07:45 AM																	
07:45 AM	0	0	0	0	3	0	9	12	5	48	0	53	0	124	1	125	190
08:00 AM	0	0	0	0	2	0	13	15	5	48	0	53	0	108	2	110	178
08:15 AM	0	0	0	0	3	0	17	20	5	46	0	51	0	88	2	90	161
08:30 AM	0	0	0	0	6	0	27	33	10	47	0	57	0	92	4	96	186
Total Volume	0	0	0	0	14	0	66	80	25	189	0	214	0	412	9	421	715
% App. Total	0	0	0	0	17.5	0	82.5		11.7	88.3	0		0	97.9	2.1		
PHF	.000	.000	.000	.000	.583	.000	.611	.606	.625	.984	.000	.939	.000	.831	.563	.842	.941

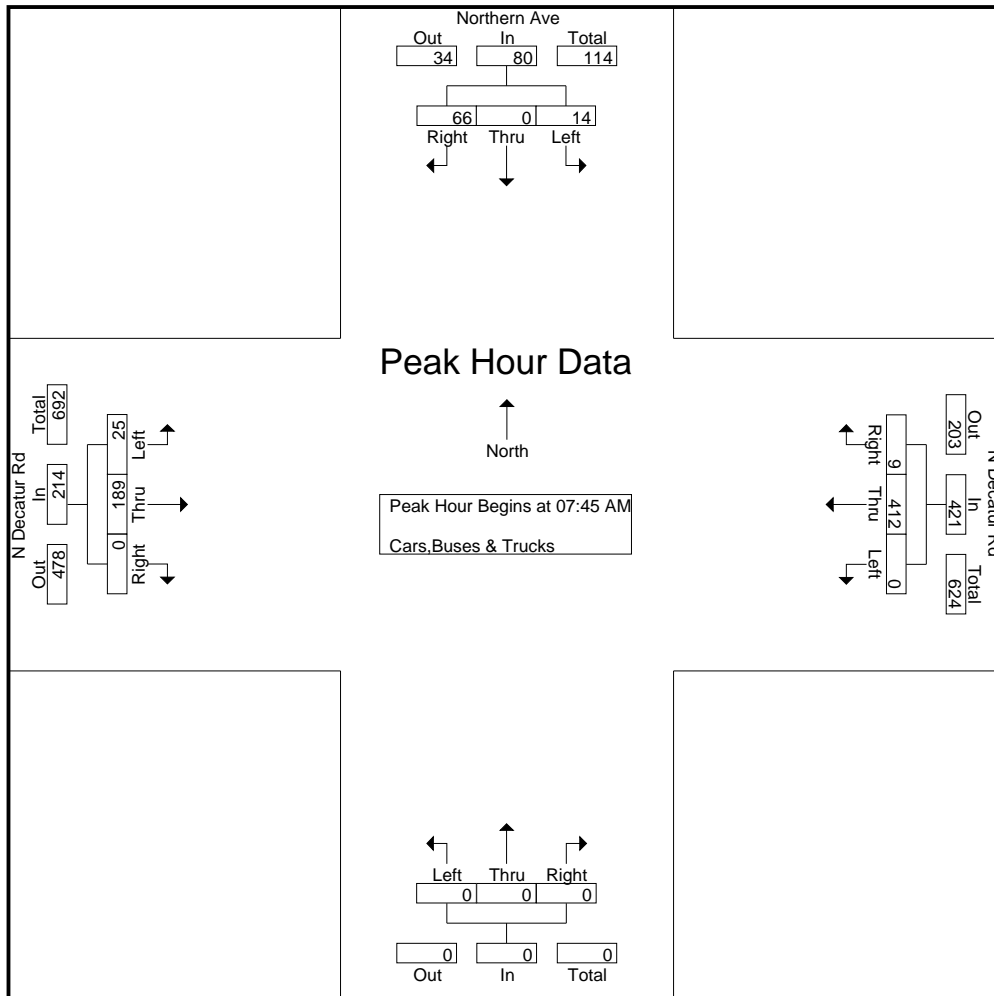

A & R Engineering, Inc

2160 Kingston Court, Suite 'O',
Marietta, GA 30067

TMC Data
Northern Ave @ North Decatur Rd
7-9 am | 4-6 pm

File Name : 20210008
Site Code : 20210008
Start Date : 1/7/2021
Page No : 3

Start Time	Northbound				Northern Ave Southbound				N Decatur Rd Eastbound				N Decatur Rd Westbound				Int. Total
	Left	Thru	Right	App. Total	Left	Thru	Right	App. Total	Left	Thru	Right	App. Total	Left	Thru	Right	App. Total	
Peak Hour Analysis From 04:00 PM to 05:45 PM - Peak 1 of 1																	
Peak Hour for Entire Intersection Begins at 04:15 PM																	
04:15 PM	0	0	0	0	15	0	16	31	17	210	0	227	0	86	6	92	350
04:30 PM	0	0	0	0	14	0	21	35	14	172	0	186	0	86	5	91	312
04:45 PM	0	0	0	0	15	0	25	40	16	200	0	216	0	82	6	88	344
05:00 PM	0	0	0	0	15	0	21	36	15	181	0	196	0	84	12	96	328
Total Volume	0	0	0	0	59	0	83	142	62	763	0	825	0	338	29	367	1334
% App. Total	0	0	0	0	41.5	0	58.5		7.5	92.5	0		0	92.1	7.9		
PHF	.000	.000	.000	.000	.983	.000	.830	.888	.912	.908	.000	.909	.000	.983	.604	.956	.953

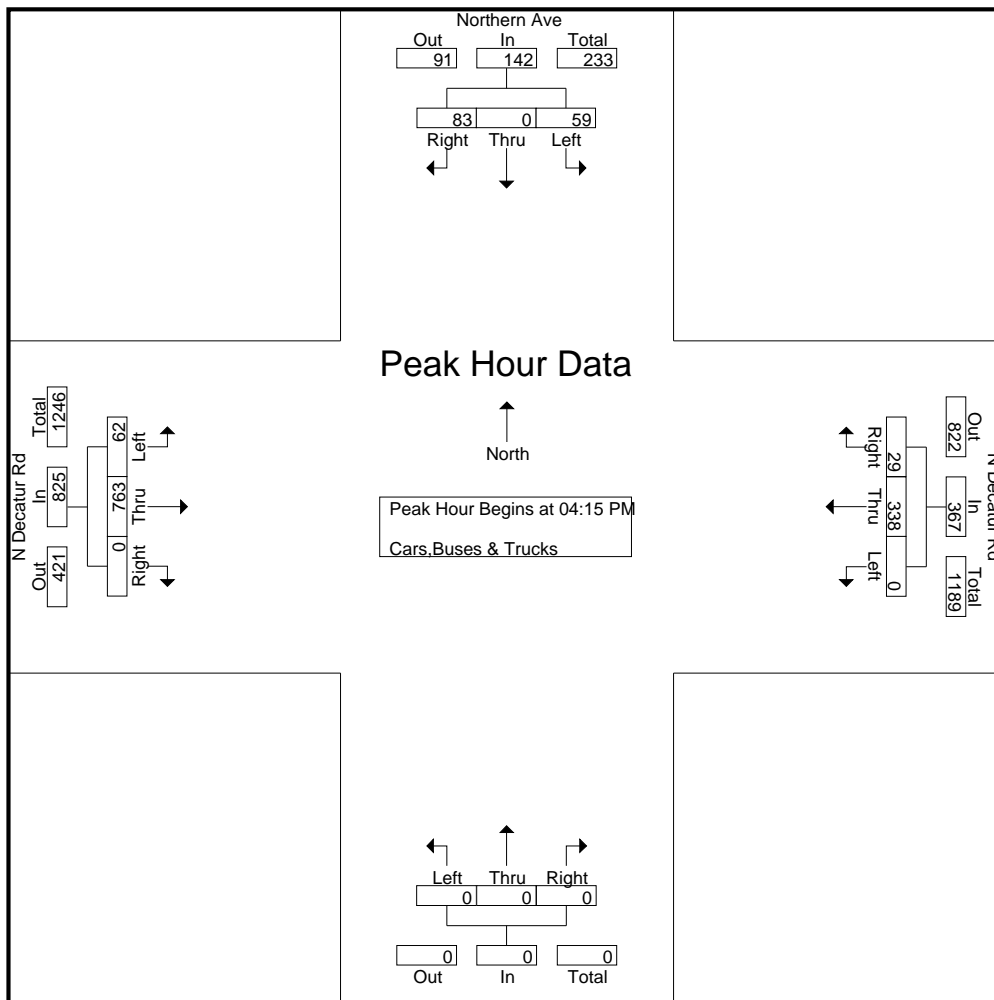

Greater Traffic Company

File Name : 01
 Site Code : 00000000
 Start Date : 9/5/2018
 Page No : 1

Groups Printed- Vehicles - Trucks - Buses

Start Time	N Indian Creek Dr Northbound					N Indian Creek Dr Southbound					Indian Creek Way Eastbound					Westbound					Int. Total
	Left	Thru	Right	Peds	App. Total	Left	Thru	Right	Peds	App. Total	Left	Thru	Right	Peds	App. Total	Left	Thru	Right	Peds	App. Total	
07:00 AM	19	122	0	0	141	0	38	7	0	45	15	0	6	0	21	0	0	0	0	0	207
07:15 AM	28	147	0	0	175	0	40	2	0	42	30	0	13	0	43	0	0	0	0	0	260
07:30 AM	17	151	0	0	168	0	69	4	0	73	29	0	20	0	49	0	0	0	0	0	290
07:45 AM	14	142	0	0	156	0	103	7	0	110	15	0	28	0	43	0	0	0	0	0	309
Total	78	562	0	0	640	0	250	20	0	270	89	0	67	0	156	0	0	0	0	0	1066
08:00 AM	15	118	0	0	133	0	118	10	0	128	6	0	20	0	26	0	0	0	0	0	287
08:15 AM	9	131	0	0	140	0	109	9	0	118	3	0	16	0	19	0	0	0	0	0	277
08:30 AM	12	137	0	0	149	0	97	7	0	104	12	0	13	0	25	0	0	0	0	0	278
08:45 AM	22	115	0	0	137	0	73	7	0	80	10	0	9	0	19	0	0	0	0	0	236
Total	58	501	0	0	559	0	397	33	0	430	31	0	58	0	89	0	0	0	0	0	1078
*** BREAK ***																					
02:00 PM	24	134	0	0	158	0	118	19	0	137	15	0	18	0	33	0	0	0	0	0	328
02:15 PM	19	144	0	0	163	0	154	22	0	176	23	0	31	0	54	0	0	0	0	0	393
02:30 PM	29	120	0	0	149	0	94	15	0	109	21	0	25	0	46	0	0	0	0	0	304
02:45 PM	22	143	0	0	165	0	118	20	0	138	19	0	33	0	52	0	0	0	0	0	355
Total	94	541	0	0	635	0	484	76	0	560	78	0	107	0	185	0	0	0	0	0	1380
03:00 PM	17	112	0	0	129	0	93	8	0	101	22	0	22	0	44	0	0	0	0	0	274
03:15 PM	14	130	0	0	144	0	116	12	0	128	19	0	23	0	42	0	0	0	0	0	314
03:30 PM	23	138	0	0	161	0	145	15	0	160	13	0	17	0	30	0	0	0	0	0	351
03:45 PM	20	149	0	0	169	0	147	8	0	155	15	0	41	0	56	0	0	0	0	0	380
Total	74	529	0	0	603	0	501	43	0	544	69	0	103	0	172	0	0	0	0	0	1319
04:00 PM	12	153	0	0	165	0	149	5	0	154	15	0	32	0	47	0	0	0	0	0	366
04:15 PM	22	149	0	0	171	0	161	10	0	171	14	0	21	0	35	0	0	0	0	0	377
04:30 PM	17	117	0	0	134	0	155	8	0	163	12	0	17	0	29	0	0	0	0	0	326
04:45 PM	17	130	0	0	147	0	155	7	0	162	13	0	32	0	45	0	0	0	0	0	354
Total	68	549	0	0	617	0	620	30	0	650	54	0	102	0	156	0	0	0	0	0	1423
05:00 PM	16	124	0	0	140	0	152	8	0	160	17	0	25	0	42	0	0	0	0	0	342
05:15 PM	17	137	0	0	154	0	169	14	0	183	13	0	25	0	38	0	0	0	0	0	375
05:30 PM	17	126	0	0	143	0	208	13	0	221	14	0	27	0	41	0	0	0	0	0	405
05:45 PM	30	108	0	0	138	0	196	7	0	203	10	0	21	0	31	0	0	0	0	0	372
Total	80	495	0	0	575	0	725	42	0	767	54	0	98	0	152	0	0	0	0	0	1494
Grand Total	452	3177	0	0	3629	0	2977	244	0	3221	375	0	535	0	910	0	0	0	0	0	7760
Apprch %	12.5	87.5	0	0		0	92.4	7.6	0		41.2	0	58.8	0		0	0	0	0		
Total %	5.8	40.9	0	0	46.8	0	38.4	3.1	0	41.5	4.8	0	6.9	0	11.7	0	0	0	0	0	
Vehicles	437	3036	0	0	3473	0	2871	238	0	3109	362	0	516	0	878	0	0	0	0	0	7460
% Vehicles	96.7	95.6	0	0	95.7	0	96.4	97.5	0	96.5	96.5	0	96.4	0	96.5	0	0	0	0	0	96.1
Trucks	1	27	0	0	28	0	28	1	0	29	0	0	1	0	1	0	0	0	0	0	58
% Trucks	0.2	0.8	0	0	0.8	0	0.9	0.4	0	0.9	0	0	0.2	0	0.1	0	0	0	0	0	0.7
Buses	14	114	0	0	128	0	78	5	0	83	13	0	18	0	31	0	0	0	0	0	242
% Buses	3.1	3.6	0	0	3.5	0	2.6	2	0	2.6	3.5	0	3.4	0	3.4	0	0	0	0	0	3.1

Greater Traffic Company

File Name : 01
 Site Code : 00000000
 Start Date : 9/5/2018
 Page No : 2

Start Time	N Indian Creek Dr Northbound					N Indian Creek Dr Southbound					Indian Creek Way Eastbound					Westbound					Int. Total
	Left	Thru	Right	Peds	App. Total	Left	Thru	Right	Peds	App. Total	Left	Thru	Right	Peds	App. Total	Left	Thru	Right	Peds	App. Total	
Peak Hour Analysis From 07:00 AM to 08:45 AM - Peak 1 of 1																					
Peak Hour for Entire Intersection Begins at 07:30 AM																					
07:30 AM	17	151	0	0	168	0	69	4	0	73	29	0	20	0	49	0	0	0	0	0	290
07:45 AM	14	142	0	0	156	0	103	7	0	110	15	0	28	0	43	0	0	0	0	0	309
08:00 AM	15	118	0	0	133	0	118	10	0	128	6	0	20	0	26	0	0	0	0	0	287
08:15 AM	9	131	0	0	140	0	109	9	0	118	3	0	16	0	19	0	0	0	0	0	277
Total Volume	55	542	0	0	597	0	399	30	0	429	53	0	84	0	137	0	0	0	0	0	1163
% App. Total	9.2	90.8	0	0		0	93	7	0		38.7	0	61.3	0		0	0	0	0	0	
PHF	.809	.897	.000	.000	.888	.000	.845	.750	.000	.838	.457	.000	.750	.000	.699	.000	.000	.000	.000	.000	.941
Vehicles	50	508	0	0	558	0	378	28	0	406	53	0	79	0	132	0	0	0	0	0	1096
% Vehicles																					
Trucks	0	9	0	0	9	0	1	0	0	1	0	0	0	0	0	0	0	0	0	0	10
% Trucks	0	1.7	0	0	1.5	0	0.3	0	0	0.2	0	0	0	0	0	0	0	0	0	0	0.9
Buses	5	25	0	0	30	0	20	2	0	22	0	0	5	0	5	0	0	0	0	0	57
% Buses	9.1	4.6	0	0	5.0	0	5.0	6.7	0	5.1	0	0	6.0	0	3.6	0	0	0	0	0	4.9

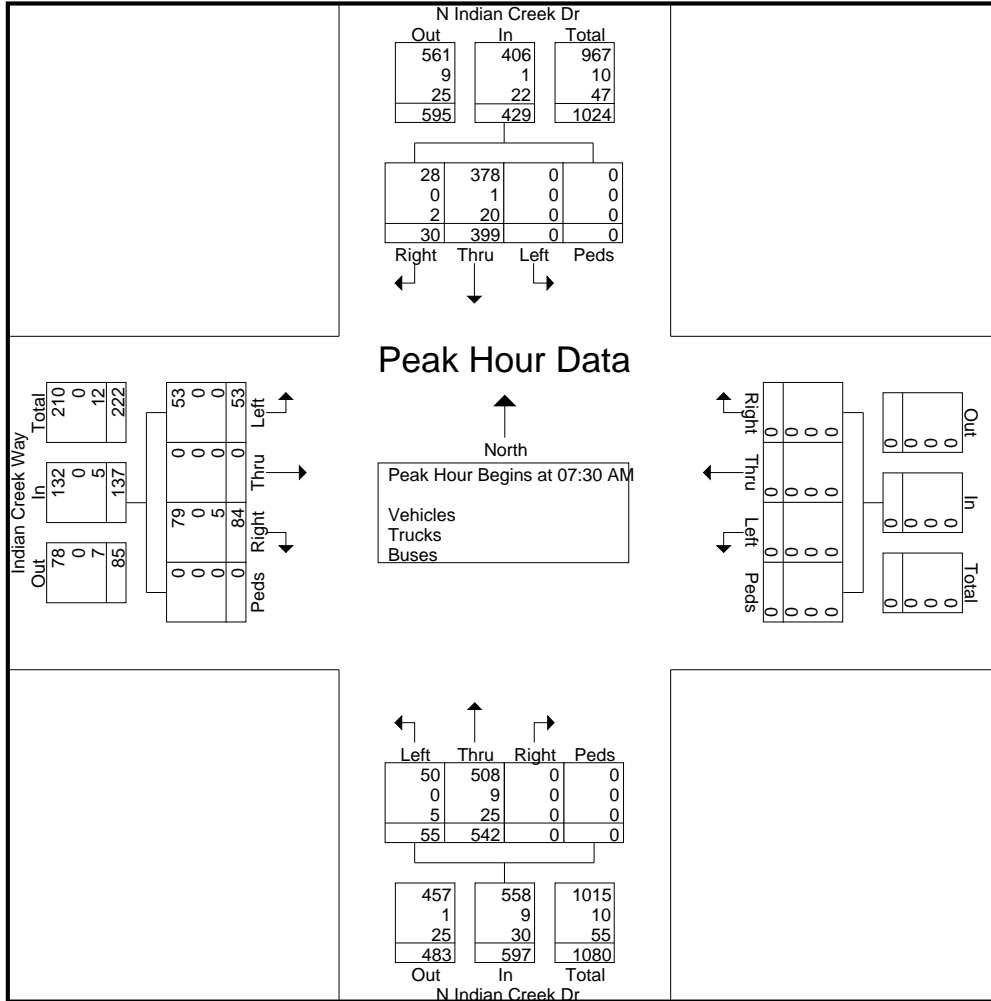

Greater Traffic Company

File Name : 01
 Site Code : 00000000
 Start Date : 9/5/2018
 Page No : 3

Start Time	N Indian Creek Dr Northbound					N Indian Creek Dr Southbound					Indian Creek Way Eastbound					Westbound					Int. Total
	Left	Thru	Right	Peds	App. Total	Left	Thru	Right	Peds	App. Total	Left	Thru	Right	Peds	App. Total	Left	Thru	Right	Peds	App. Total	
Peak Hour Analysis From 04:00 PM to 05:45 PM - Peak 1 of 1																					
Peak Hour for Entire Intersection Begins at 05:00 PM																					
05:00 PM	16	124	0	0	140	0	152	8	0	160	17	0	25	0	42	0	0	0	0	0	342
05:15 PM	17	137	0	0	154	0	169	14	0	183	13	0	25	0	38	0	0	0	0	0	375
05:30 PM	17	126	0	0	143	0	208	13	0	221	14	0	27	0	41	0	0	0	0	0	405
05:45 PM	30	108	0	0	138	0	196	7	0	203	10	0	21	0	31	0	0	0	0	0	372
Total Volume	80	495	0	0	575	0	725	42	0	767	54	0	98	0	152	0	0	0	0	0	1494
% App. Total	13.9	86.1	0	0		0	94.5	5.5	0		35.5	0	64.5	0		0	0	0	0	0	
PHF	.667	.903	.000	.000	.933	.000	.871	.750	.000	.868	.794	.000	.907	.000	.905	.000	.000	.000	.000	.000	.922
Vehicles	80	488	0	0	568	0	714	41	0	755	53	0	96	0	149	0	0	0	0	0	1472
% Vehicles																					
Trucks	0	2	0	0	2	0	4	1	0	5	0	0	0	0	0	0	0	0	0	0	7
% Trucks	0	0.4	0	0	0.3	0	0.6	2.4	0	0.7	0	0	0	0	0	0	0	0	0	0	0.5
Buses	0	5	0	0	5	0	7	0	0	7	1	0	2	0	3	0	0	0	0	0	15
% Buses	0	1.0	0	0	0.9	0	1.0	0	0	0.9	1.9	0	2.0	0	2.0	0	0	0	0	0	1.0

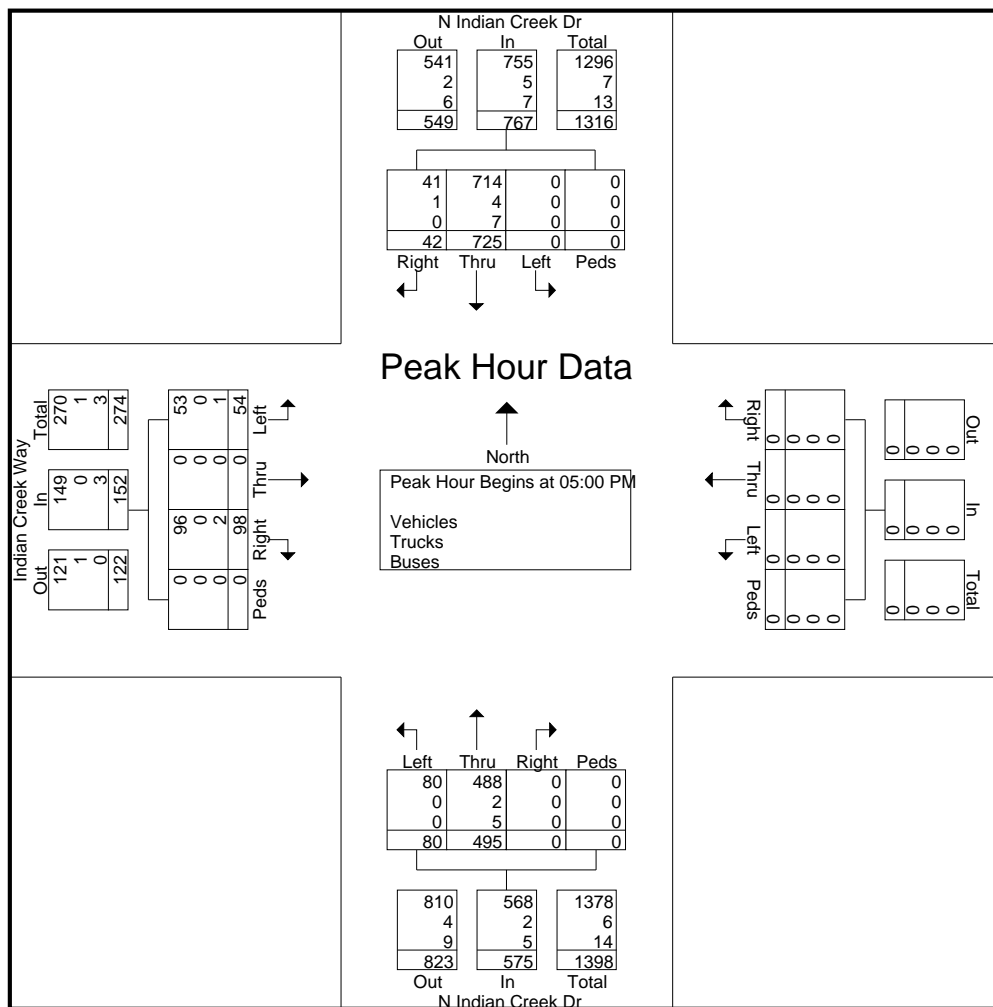

LINEAR REGRESSION OF DAILY TRAFFIC

Location	Growth Rate	R Squared	Station ID	Route	2017	2018	2019
N.Indian Creek Dr (E of Indian Creek V	1.8%	1.00	089-3754	00517200	16,800	17,100	17,400
N.Indian Creek Dr (SE of Rockbridge R	1.6%	0.98	089-7163	00084800	9,880	10,000	10,200
N.Decatur Rd (W of N.Indian Creek Dr	0.3%	0.75	089-3729	00514800	15,100	15,100	15,200
N.Decatur Rd (W of I 285)	0.8%	0.75	089-3727	00514800	18,800	18,800	19,100
E. Ponce De Leon Ave (W of I 285)	0.3%	0.75	089-3736	00515100	14,600	14,600	14,700
Weighted Average	0.9%	0.95	Sum of Count Stations =		75,180	75,600	76,600

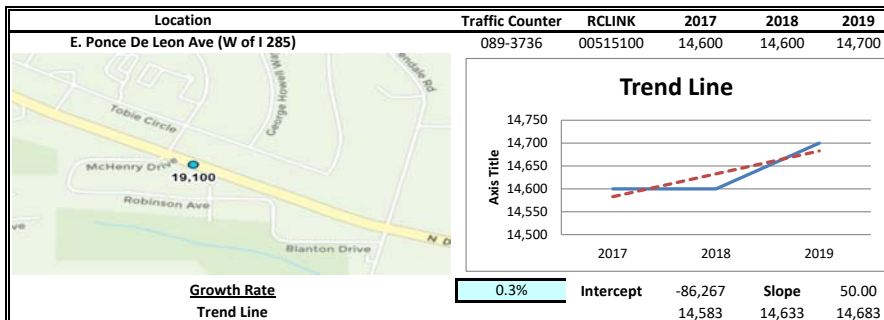
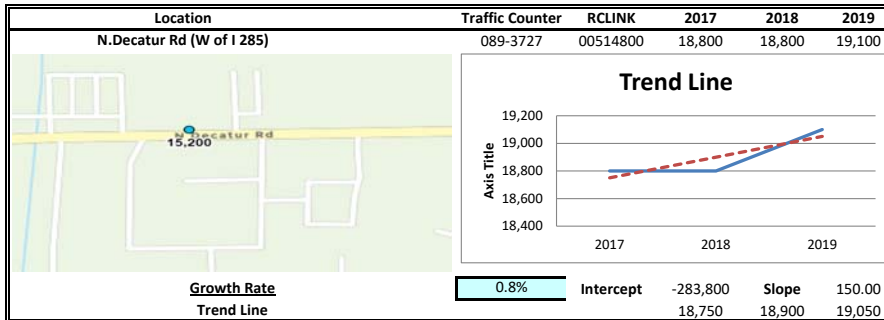
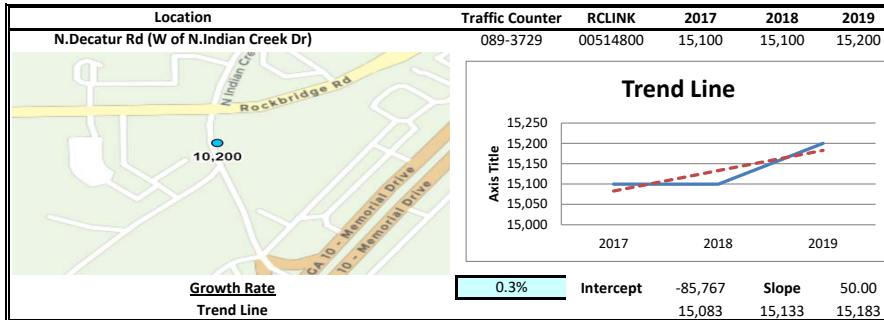
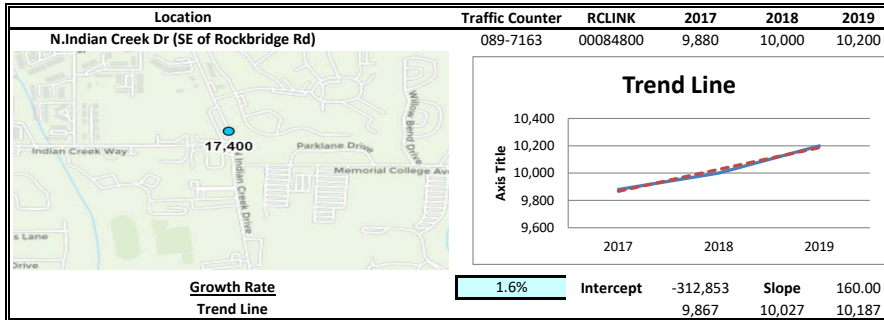
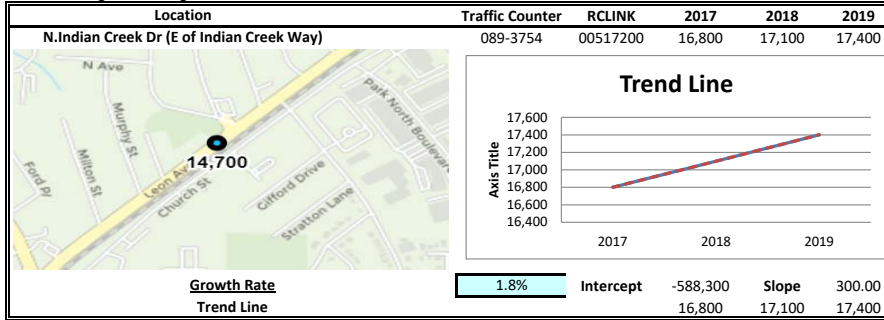

EXISTING INTERSECTION ANALYSIS

Intersection						
Int Delay, s/veh	3.7					
Movement	EBT	EBR	WBL	WBT	NBL	NBR
Lane Configurations	↑	↗		↖	↖	↗
Traffic Vol, veh/h	202	36	94	260	53	114
Future Vol, veh/h	202	36	94	260	53	114
Conflicting Peds, #/hr	0	0	0	0	0	0
Sign Control	Free	Free	Free	Free	Stop	Stop
RT Channelized	-	None	-	None	-	None
Storage Length	-	270	-	-	0	30
Veh in Median Storage, #	0	-	-	0	0	-
Grade, %	0	-	-	0	0	-
Peak Hour Factor	90	90	90	90	90	90
Heavy Vehicles, %	2	2	2	2	2	2
Mvmt Flow	224	40	104	289	59	127

Major/Minor	Major1	Major2	Minor1		
Conflicting Flow All	0	0	264	0	721
Stage 1	-	-	-	-	224
Stage 2	-	-	-	-	497
Critical Hdwy	-	-	4.12	-	6.42
Critical Hdwy Stg 1	-	-	-	-	5.42
Critical Hdwy Stg 2	-	-	-	-	5.42
Follow-up Hdwy	-	-	2.218	-	3.518
Pot Cap-1 Maneuver	-	-	1300	-	394
Stage 1	-	-	-	-	813
Stage 2	-	-	-	-	611
Platoon blocked, %	-	-	-	-	-
Mov Cap-1 Maneuver	-	-	1300	-	357
Mov Cap-2 Maneuver	-	-	-	-	357
Stage 1	-	-	-	-	813
Stage 2	-	-	-	-	553

Approach	EB	WB	NB
HCM Control Delay, s	0	2.1	12.4
HCM LOS			B

Minor Lane/Major Mvmt	NBLn1	NBLn2	EBT	EBR	WBL	WBT
Capacity (veh/h)	357	815	-	-	1300	-
HCM Lane V/C Ratio	0.165	0.155	-	-	0.08	-
HCM Control Delay (s)	17.1	10.2	-	-	8	0
HCM Lane LOS	C	B	-	-	A	A
HCM 95th %tile Q(veh)	0.6	0.5	-	-	0.3	-

Intersection						
Int Delay, s/veh	4.4					
Movement	WBL	WBR	NBT	NBR	SBL	SBT
Lane Configurations						
Traffic Vol, veh/h	22	61	75	14	68	63
Future Vol, veh/h	22	61	75	14	68	63
Conflicting Peds, #/hr	0	0	0	0	0	0
Sign Control	Stop	Stop	Free	Free	Free	Free
RT Channelized	-	None	-	None	-	None
Storage Length	0	-	-	-	-	-
Veh in Median Storage, #	0	-	0	-	-	0
Grade, %	0	-	0	-	-	0
Peak Hour Factor	86	86	86	86	86	86
Heavy Vehicles, %	2	2	2	2	2	2
Mvmt Flow	26	71	87	16	79	73

Major/Minor	Minor1	Major1	Major2			
Conflicting Flow All	326	95	0	0	103	0
Stage 1	95	-	-	-	-	-
Stage 2	231	-	-	-	-	-
Critical Hdwy	6.42	6.22	-	-	4.12	-
Critical Hdwy Stg 1	5.42	-	-	-	-	-
Critical Hdwy Stg 2	5.42	-	-	-	-	-
Follow-up Hdwy	3.518	3.318	-	-	2.218	-
Pot Cap-1 Maneuver	668	962	-	-	1489	-
Stage 1	929	-	-	-	-	-
Stage 2	807	-	-	-	-	-
Platoon blocked, %			-	-		-
Mov Cap-1 Maneuver	631	962	-	-	1489	-
Mov Cap-2 Maneuver	631	-	-	-	-	-
Stage 1	929	-	-	-	-	-
Stage 2	763	-	-	-	-	-

Approach	WB	NB	SB
HCM Control Delay, s	9.8	0	3.9
HCM LOS	A		

Minor Lane/Major Mvmt	NBT	NBRWBLn1	SBL	SBT
Capacity (veh/h)	-	-	845	1489
HCM Lane V/C Ratio	-	-	0.114	0.053
HCM Control Delay (s)	-	-	9.8	7.6
HCM Lane LOS	-	-	A	A
HCM 95th %tile Q(veh)	-	-	0.4	0.2

Timings
3: N. Decatur Rd & Northern Ave

Existing AM
01/14/2021



Lane Group	EBL	EBT	WBT	SBL
Lane Configurations	↖	↗↗	↗↖	↘
Traffic Volume (vph)	43	321	700	24
Future Volume (vph)	43	321	700	24
Lane Group Flow (vph)	46	341	761	145
Turn Type	Perm	NA	NA	Prot
Protected Phases		2	6	4
Permitted Phases	2			
Detector Phase	2	2	6	4
Switch Phase				
Minimum Initial (s)	15.0	15.0	15.0	6.0
Minimum Split (s)	23.5	23.5	23.5	30.5
Total Split (s)	71.4	71.4	71.4	48.6
Total Split (%)	59.5%	59.5%	59.5%	40.5%
Yellow Time (s)	3.5	3.5	3.5	3.5
All-Red Time (s)	2.0	2.0	2.0	2.0
Lost Time Adjust (s)	0.0	0.0	0.0	0.0
Total Lost Time (s)	5.5	5.5	5.5	5.5
Lead/Lag				
Lead-Lag Optimize?				
Recall Mode	C-Min	C-Min	C-Min	None
v/c Ratio	0.08	0.12	0.26	0.63
Control Delay	2.6	2.1	2.5	26.4
Queue Delay	0.0	0.0	0.0	0.0
Total Delay	2.6	2.1	2.5	26.4
Queue Length 50th (ft)	4	17	44	20
Queue Length 95th (ft)	15	36	85	82
Internal Link Dist (ft)		586	931	454
Turn Bay Length (ft)	100			
Base Capacity (vph)	562	2955	2947	665
Starvation Cap Reductn	0	0	0	0
Spillback Cap Reductn	0	0	0	0
Storage Cap Reductn	0	0	0	0
Reduced v/c Ratio	0.08	0.12	0.26	0.22

Intersection Summary

Cycle Length: 120
 Actuated Cycle Length: 120
 Offset: 0 (0%), Referenced to phase 2:EBTL and 6:WBT, Start of Green
 Natural Cycle: 55
 Control Type: Actuated-Coordinated

Splits and Phases: 3: N. Decatur Rd & Northern Ave

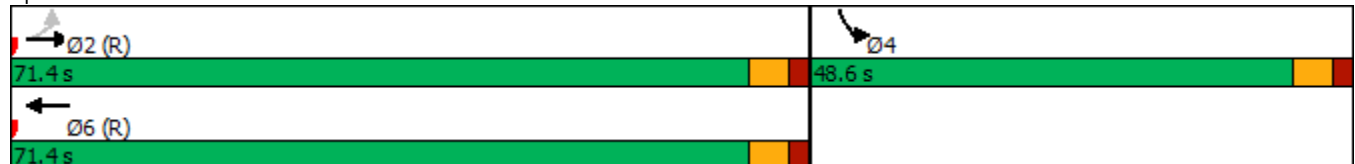

HCM 6th Signalized Intersection Summary

3: N. Decatur Rd & Northern Ave

Existing AM
01/14/2021



Movement	EBL	EBT	WBT	WBR	SBL	SBR
Lane Configurations						
Traffic Volume (veh/h)	43	321	700	15	24	112
Future Volume (veh/h)	43	321	700	15	24	112
Initial Q (Qb), veh	0	0	0	0	0	0
Ped-Bike Adj(A_pbT)	1.00			1.00	1.00	1.00
Parking Bus, Adj	1.00	1.00	1.00	1.00	1.00	1.00
Work Zone On Approach		No	No		No	
Adj Sat Flow, veh/h/ln	1870	1870	1870	1870	1870	1870
Adj Flow Rate, veh/h	46	341	745	16	26	0
Peak Hour Factor	0.94	0.94	0.94	0.94	0.94	0.94
Percent Heavy Veh, %	2	2	2	2	2	2
Cap, veh/h	657	3122	3125	67	51	
Arrive On Green	0.88	0.88	0.88	0.88	0.03	0.00
Sat Flow, veh/h	705	3647	3651	76	1718	0
Grp Volume(v), veh/h	46	341	372	389	27	0
Grp Sat Flow(s),veh/h/ln	705	1777	1777	1857	1784	0
Q Serve(g_s), s	1.3	1.5	3.9	3.9	1.8	0.0
Cycle Q Clear(g_c), s	5.1	1.5	3.9	3.9	1.8	0.0
Prop In Lane	1.00			0.04	0.96	0.00
Lane Grp Cap(c), veh/h	657	3122	1561	1631	53	
V/C Ratio(X)	0.07	0.11	0.24	0.24	0.51	
Avail Cap(c_a), veh/h	657	3122	1561	1631	641	
HCM Platoon Ratio	1.00	1.00	1.00	1.00	1.00	1.00
Upstream Filter(I)	1.00	1.00	1.00	1.00	1.00	0.00
Uniform Delay (d), s/veh	1.5	1.0	1.1	1.1	57.4	0.0
Incr Delay (d2), s/veh	0.2	0.1	0.4	0.3	7.4	0.0
Initial Q Delay(d3),s/veh	0.0	0.0	0.0	0.0	0.0	0.0
%ile BackOfQ(50%),veh/ln	0.1	0.2	0.5	0.5	0.9	0.0
Unsig. Movement Delay, s/veh						
LnGrp Delay(d),s/veh	1.7	1.0	1.5	1.5	64.8	0.0
LnGrp LOS	A	A	A	A	E	
Approach Vol, veh/h		387	761		27	A
Approach Delay, s/veh		1.1	1.5		64.8	
Approach LOS		A	A		E	
Timer - Assigned Phs		2		4		6
Phs Duration (G+Y+Rc), s		110.9		9.1		110.9
Change Period (Y+Rc), s		5.5		5.5		5.5
Max Green Setting (Gmax), s		65.9		43.1		65.9
Max Q Clear Time (g_c+I1), s		7.1		3.8		5.9
Green Ext Time (p_c), s		5.4		0.1		11.4

Intersection Summary

HCM 6th Ctrl Delay	2.8
HCM 6th LOS	A

Notes

User approved volume balancing among the lanes for turning movement.

Unsignalized Delay for [SBR] is excluded from calculations of the approach delay and intersection delay.

Timings
4: N.Indian Creek Dr & Indian Creek Way

Existing AM
01/14/2021



Lane Group	EBL	NBL	NBT	SBT
Lane Configurations				
Traffic Volume (vph)	68	96	580	263
Future Volume (vph)	68	96	580	263
Lane Group Flow (vph)	147	100	604	417
Turn Type	Prot	Perm	NA	NA
Protected Phases	4		2	6
Permitted Phases		2		
Detector Phase	4	2	2	6
Switch Phase				
Minimum Initial (s)	6.0	15.0	15.0	15.0
Minimum Split (s)	61.5	57.5	57.5	23.5
Total Split (s)	61.5	58.5	58.5	58.5
Total Split (%)	51.3%	48.8%	48.8%	48.8%
Yellow Time (s)	3.5	3.5	3.5	3.5
All-Red Time (s)	2.0	2.0	2.0	2.0
Lost Time Adjust (s)	0.0	0.0	0.0	0.0
Total Lost Time (s)	5.5	5.5	5.5	5.5
Lead/Lag				
Lead-Lag Optimize?				
Recall Mode	None	C-Min	C-Min	C-Min
v/c Ratio	0.66	0.13	0.40	0.29
Control Delay	43.9	3.4	4.6	3.6
Queue Delay	0.0	0.0	0.0	0.0
Total Delay	43.9	3.4	4.6	3.6
Queue Length 50th (ft)	64	13	105	58
Queue Length 95th (ft)	128	34	201	118
Internal Link Dist (ft)	1475		446	669
Turn Bay Length (ft)		50		
Base Capacity (vph)	821	769	1506	1442
Starvation Cap Reductn	0	0	0	0
Spillback Cap Reductn	0	0	0	0
Storage Cap Reductn	0	0	0	0
Reduced v/c Ratio	0.18	0.13	0.40	0.29

Intersection Summary

Cycle Length: 120
 Actuated Cycle Length: 120
 Offset: 0 (0%), Referenced to phase 2:NBTL and 6:SBT, Start of Green
 Natural Cycle: 120
 Control Type: Actuated-Coordinated

Splits and Phases: 4: N.Indian Creek Dr & Indian Creek Way

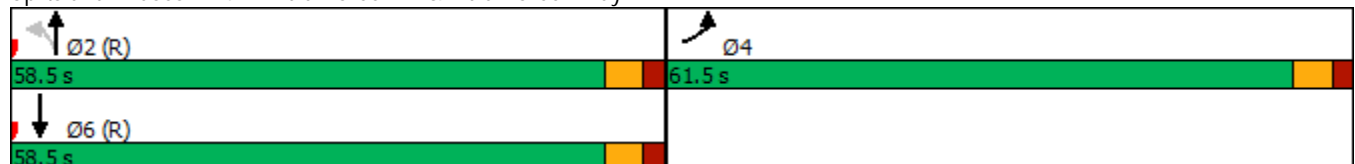

HCM 6th Signalized Intersection Summary
4: N.Indian Creek Dr & Indian Creek Way

Existing AM
01/14/2021



Movement	EBL	EBR	NBL	NBT	SBT	SBR
Lane Configurations						
Traffic Volume (veh/h)	68	73	96	580	263	137
Future Volume (veh/h)	68	73	96	580	263	137
Initial Q (Qb), veh	0	0	0	0	0	0
Ped-Bike Adj(A_pbT)	1.00	1.00	1.00			1.00
Parking Bus, Adj	1.00	1.00	1.00	1.00	1.00	1.00
Work Zone On Approach	No			No	No	
Adj Sat Flow, veh/h/ln	1870	1870	1870	1870	1870	1870
Adj Flow Rate, veh/h	71	76	100	604	274	143
Peak Hour Factor	0.96	0.96	0.96	0.96	0.96	0.96
Percent Heavy Veh, %	2	2	2	2	2	2
Cap, veh/h	86	92	778	1500	928	484
Arrive On Green	0.11	0.11	0.80	0.80	0.80	0.80
Sat Flow, veh/h	804	860	969	1870	1158	604
Grp Volume(v), veh/h	148	0	100	604	0	417
Grp Sat Flow(s),veh/h/ln	1675	0	969	1870	0	1762
Q Serve(g_s), s	10.4	0.0	3.6	11.3	0.0	7.4
Cycle Q Clear(g_c), s	10.4	0.0	11.0	11.3	0.0	7.4
Prop In Lane	0.48	0.51	1.00			0.34
Lane Grp Cap(c), veh/h	178	0	778	1500	0	1413
V/C Ratio(X)	0.83	0.00	0.13	0.40	0.00	0.30
Avail Cap(c_a), veh/h	782	0	778	1500	0	1413
HCM Platoon Ratio	1.00	1.00	1.00	1.00	1.00	1.00
Upstream Filter(I)	1.00	0.00	1.00	1.00	0.00	1.00
Uniform Delay (d), s/veh	52.5	0.0	4.5	3.5	0.0	3.1
Incr Delay (d2), s/veh	9.5	0.0	0.3	0.8	0.0	0.5
Initial Q Delay(d3),s/veh	0.0	0.0	0.0	0.0	0.0	0.0
%ile BackOfQ(50%),veh/ln	4.9	0.0	0.7	3.5	0.0	2.1
Unsig. Movement Delay, s/veh						
LnGrp Delay(d),s/veh	62.0	0.0	4.8	4.3	0.0	3.6
LnGrp LOS	E	A	A	A	A	A
Approach Vol, veh/h	148			704	417	
Approach Delay, s/veh	62.0			4.4	3.6	
Approach LOS	E			A	A	
Timer - Assigned Phs		2		4		6
Phs Duration (G+Y+Rc), s		101.7		18.3		101.7
Change Period (Y+Rc), s		5.5		5.5		5.5
Max Green Setting (Gmax), s		53.0		56.0		53.0
Max Q Clear Time (g_c+I1), s		13.3		12.4		9.4
Green Ext Time (p_c), s		5.1		0.5		2.9
Intersection Summary						
HCM 6th Ctrl Delay			10.8			
HCM 6th LOS			B			

Notes

User approved volume balancing among the lanes for turning movement.

Intersection						
Int Delay, s/veh	3					
Movement	EBT	EBR	WBL	WBT	NBL	NBR
Lane Configurations	↑	↑		↑	↑	↑
Traffic Vol, veh/h	252	86	151	294	20	90
Future Vol, veh/h	252	86	151	294	20	90
Conflicting Peds, #/hr	0	0	0	0	0	0
Sign Control	Free	Free	Free	Free	Stop	Stop
RT Channelized	-	None	-	None	-	None
Storage Length	-	270	-	-	0	30
Veh in Median Storage, #	0	-	-	0	0	-
Grade, %	0	-	-	0	0	-
Peak Hour Factor	91	91	91	91	91	91
Heavy Vehicles, %	2	2	2	2	2	2
Mvmt Flow	277	95	166	323	22	99

Major/Minor	Major1	Major2	Minor1			
Conflicting Flow All	0	0	372	0	932	277
Stage 1	-	-	-	-	277	-
Stage 2	-	-	-	-	655	-
Critical Hdwy	-	-	4.12	-	6.42	6.22
Critical Hdwy Stg 1	-	-	-	-	5.42	-
Critical Hdwy Stg 2	-	-	-	-	5.42	-
Follow-up Hdwy	-	-	2.218	-	3.518	3.318
Pot Cap-1 Maneuver	-	-	1186	-	296	762
Stage 1	-	-	-	-	770	-
Stage 2	-	-	-	-	517	-
Platoon blocked, %	-	-	-	-	-	-
Mov Cap-1 Maneuver	-	-	1186	-	245	762
Mov Cap-2 Maneuver	-	-	-	-	245	-
Stage 1	-	-	-	-	770	-
Stage 2	-	-	-	-	429	-

Approach	EB	WB	NB
HCM Control Delay, s	0	2.9	12.3
HCM LOS			B

Minor Lane/Major Mvmt	NBLn1	NBLn2	EBT	EBR	WBL	WBT
Capacity (veh/h)	245	762	-	-	1186	-
HCM Lane V/C Ratio	0.09	0.13	-	-	0.14	-
HCM Control Delay (s)	21.1	10.4	-	-	8.5	0
HCM Lane LOS	C	B	-	-	A	A
HCM 95th %tile Q(veh)	0.3	0.4	-	-	0.5	-

Intersection						
Int Delay, s/veh	3.7					
Movement	WBL	WBR	NBT	NBR	SBL	SBT
Lane Configurations						
Traffic Vol, veh/h	29	56	66	26	74	138
Future Vol, veh/h	29	56	66	26	74	138
Conflicting Peds, #/hr	0	0	0	0	0	0
Sign Control	Stop	Stop	Free	Free	Free	Free
RT Channelized	-	None	-	None	-	None
Storage Length	0	-	-	-	-	-
Veh in Median Storage, #	0	-	0	-	-	0
Grade, %	0	-	0	-	-	0
Peak Hour Factor	86	86	86	86	86	86
Heavy Vehicles, %	2	2	2	2	2	2
Mvmt Flow	34	65	77	30	86	160

Major/Minor	Minor1	Major1	Major2			
Conflicting Flow All	424	92	0	0	107	0
Stage 1	92	-	-	-	-	-
Stage 2	332	-	-	-	-	-
Critical Hdwy	6.42	6.22	-	-	4.12	-
Critical Hdwy Stg 1	5.42	-	-	-	-	-
Critical Hdwy Stg 2	5.42	-	-	-	-	-
Follow-up Hdwy	3.518	3.318	-	-	2.218	-
Pot Cap-1 Maneuver	587	965	-	-	1484	-
Stage 1	932	-	-	-	-	-
Stage 2	727	-	-	-	-	-
Platoon blocked, %			-	-	-	-
Mov Cap-1 Maneuver	549	965	-	-	1484	-
Mov Cap-2 Maneuver	549	-	-	-	-	-
Stage 1	932	-	-	-	-	-
Stage 2	680	-	-	-	-	-

Approach	WB	NB	SB
HCM Control Delay, s	10.4	0	2.6
HCM LOS	B		

Minor Lane/Major Mvmt	NBT	NBRWBLn1	SBL	SBT
Capacity (veh/h)	-	-	767	1484
HCM Lane V/C Ratio	-	-	0.129	0.058
HCM Control Delay (s)	-	-	10.4	7.6
HCM Lane LOS	-	-	B	A
HCM 95th %tile Q(veh)	-	-	0.4	0.2

Timings
3: N. Decatur Rd & Northern Ave

Existing PM
01/14/2021



Lane Group	EBL	EBT	WBT	SBL
Lane Configurations	↖	↑↑	↑↑	↘
Traffic Volume (vph)	71	877	389	68
Future Volume (vph)	71	877	389	68
Lane Group Flow (vph)	75	923	444	172
Turn Type	Perm	NA	NA	Prot
Protected Phases		2	6	4
Permitted Phases	2			
Detector Phase	2	2	6	4
Switch Phase				
Minimum Initial (s)	15.0	15.0	15.0	6.0
Minimum Split (s)	23.5	23.5	23.5	30.5
Total Split (s)	71.4	71.4	71.4	48.6
Total Split (%)	59.5%	59.5%	59.5%	40.5%
Yellow Time (s)	3.5	3.5	3.5	3.5
All-Red Time (s)	2.0	2.0	2.0	2.0
Lost Time Adjust (s)	0.0	0.0	0.0	0.0
Total Lost Time (s)	5.5	5.5	5.5	5.5
Lead/Lag				
Lead-Lag Optimize?				
Recall Mode	C-Min	C-Min	C-Min	None
v/c Ratio	0.10	0.33	0.16	0.70
Control Delay	3.8	4.1	3.3	46.3
Queue Delay	0.0	0.0	0.0	0.0
Total Delay	3.8	4.1	3.3	46.3
Queue Length 50th (ft)	10	83	33	80
Queue Length 95th (ft)	29	143	61	148
Internal Link Dist (ft)		586	931	454
Turn Bay Length (ft)	100			
Base Capacity (vph)	734	2820	2789	645
Starvation Cap Reductn	0	0	0	0
Spillback Cap Reductn	0	0	0	0
Storage Cap Reductn	0	0	0	0
Reduced v/c Ratio	0.10	0.33	0.16	0.27

Intersection Summary

Cycle Length: 120
 Actuated Cycle Length: 120
 Offset: 0 (0%), Referenced to phase 2:EBTL and 6:WBT, Start of Green
 Natural Cycle: 55
 Control Type: Actuated-Coordinated

Splits and Phases: 3: N. Decatur Rd & Northern Ave

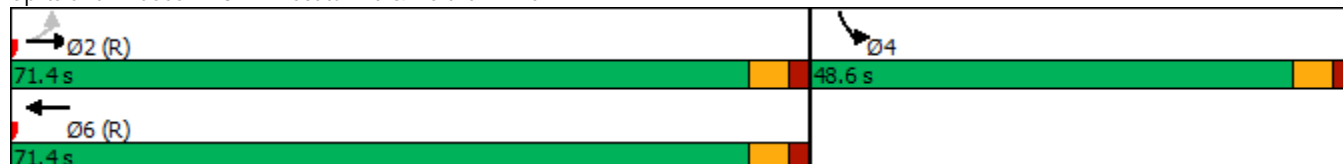

HCM 6th Signalized Intersection Summary

3: N. Decatur Rd & Northern Ave

Existing PM
01/14/2021



Movement	EBL	EBT	WBT	WBR	SBL	SBR
Lane Configurations						
Traffic Volume (veh/h)	71	877	389	33	68	95
Future Volume (veh/h)	71	877	389	33	68	95
Initial Q (Qb), veh	0	0	0	0	0	0
Ped-Bike Adj(A_pbT)	1.00			1.00	1.00	1.00
Parking Bus, Adj	1.00	1.00	1.00	1.00	1.00	1.00
Work Zone On Approach		No	No		No	
Adj Sat Flow, veh/h/ln	1870	1870	1870	1870	1870	1870
Adj Flow Rate, veh/h	75	923	409	35	72	0
Peak Hour Factor	0.95	0.95	0.95	0.95	0.95	0.95
Percent Heavy Veh, %	2	2	2	2	2	2
Cap, veh/h	849	3038	2833	241	94	
Arrive On Green	0.85	0.85	0.85	0.85	0.05	0.00
Sat Flow, veh/h	946	3647	3408	282	1758	0
Grp Volume(v), veh/h	75	923	218	226	73	0
Grp Sat Flow(s),veh/h/ln	946	1777	1777	1820	1782	0
Q Serve(g_s), s	1.7	6.1	2.4	2.5	4.9	0.0
Cycle Q Clear(g_c), s	4.2	6.1	2.4	2.5	4.9	0.0
Prop In Lane	1.00			0.16	0.99	0.00
Lane Grp Cap(c), veh/h	849	3038	1519	1555	95	
V/C Ratio(X)	0.09	0.30	0.14	0.14	0.77	
Avail Cap(c_a), veh/h	849	3038	1519	1555	640	
HCM Platoon Ratio	1.00	1.00	1.00	1.00	1.00	1.00
Upstream Filter(I)	1.00	1.00	1.00	1.00	1.00	0.00
Uniform Delay (d), s/veh	1.8	1.7	1.4	1.4	56.1	0.0
Incr Delay (d2), s/veh	0.2	0.3	0.2	0.2	12.0	0.0
Initial Q Delay(d3),s/veh	0.0	0.0	0.0	0.0	0.0	0.0
%ile BackOfQ(50%),veh/ln	0.2	1.0	0.5	0.5	2.5	0.0
Unsig. Movement Delay, s/veh						
LnGrp Delay(d),s/veh	2.0	2.0	1.6	1.6	68.1	0.0
LnGrp LOS	A	A	A	A	E	
Approach Vol, veh/h		998	444		73	A
Approach Delay, s/veh		2.0	1.6		68.1	
Approach LOS		A	A		E	
Timer - Assigned Phs		2		4		6
Phs Duration (G+Y+Rc), s		108.1		11.9		108.1
Change Period (Y+Rc), s		5.5		5.5		5.5
Max Green Setting (Gmax), s		65.9		43.1		65.9
Max Q Clear Time (g_c+I1), s		8.1		6.9		4.5
Green Ext Time (p_c), s		17.8		0.2		5.7

Intersection Summary

HCM 6th Ctrl Delay	5.1
HCM 6th LOS	A

Notes

User approved volume balancing among the lanes for turning movement.
Unsignalized Delay for [SBR] is excluded from calculations of the approach delay and intersection delay.

Timings
4: N.Indian Creek Dr & Indian Creek Way

Existing PM
01/14/2021



Lane Group	EBL	NBL	NBT	SBT
Lane Configurations				
Traffic Volume (vph)	57	84	520	761
Future Volume (vph)	57	84	520	761
Lane Group Flow (vph)	162	85	525	816
Turn Type	Prot	Perm	NA	NA
Protected Phases	4		2	6
Permitted Phases		2		
Detector Phase	4	2	2	6
Switch Phase				
Minimum Initial (s)	6.0	15.0	15.0	15.0
Minimum Split (s)	61.5	57.5	57.5	23.5
Total Split (s)	61.5	58.5	58.5	58.5
Total Split (%)	51.3%	48.8%	48.8%	48.8%
Yellow Time (s)	3.5	3.5	3.5	3.5
All-Red Time (s)	2.0	2.0	2.0	2.0
Lost Time Adjust (s)	0.0	0.0	0.0	0.0
Total Lost Time (s)	5.5	5.5	5.5	5.5
Lead/Lag				
Lead-Lag Optimize?				
Recall Mode	None	C-Min	C-Min	C-Min
v/c Ratio	0.68	0.18	0.34	0.54
Control Delay	34.4	3.9	3.8	5.6
Queue Delay	0.0	0.0	0.0	0.0
Total Delay	34.4	3.9	3.8	5.6
Queue Length 50th (ft)	46	10	77	153
Queue Length 95th (ft)	113	31	156	310
Internal Link Dist (ft)	1475		446	669
Turn Bay Length (ft)		50		
Base Capacity (vph)	833	475	1526	1514
Starvation Cap Reductn	0	0	0	0
Spillback Cap Reductn	0	0	0	0
Storage Cap Reductn	0	0	0	0
Reduced v/c Ratio	0.19	0.18	0.34	0.54

Intersection Summary

Cycle Length: 120
 Actuated Cycle Length: 120
 Offset: 0 (0%), Referenced to phase 2:NBTL and 6:SBT, Start of Green
 Natural Cycle: 130
 Control Type: Actuated-Coordinated

Splits and Phases: 4: N.Indian Creek Dr & Indian Creek Way

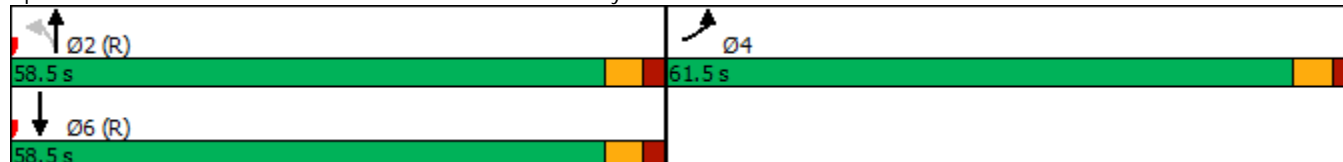

HCM 6th Signalized Intersection Summary
4: N.Indian Creek Dr & Indian Creek Way

Existing PM
01/14/2021



Movement	EBL	EBR	NBL	NBT	SBT	SBR
Lane Configurations						
Traffic Volume (veh/h)	57	103	84	520	761	47
Future Volume (veh/h)	57	103	84	520	761	47
Initial Q (Qb), veh	0	0	0	0	0	0
Ped-Bike Adj(A_pbT)	1.00	1.00	1.00			1.00
Parking Bus, Adj	1.00	1.00	1.00	1.00	1.00	1.00
Work Zone On Approach	No			No	No	
Adj Sat Flow, veh/h/ln	1870	1870	1870	1870	1870	1870
Adj Flow Rate, veh/h	58	104	85	525	769	47
Peak Hour Factor	0.99	0.99	0.99	0.99	0.99	0.99
Percent Heavy Veh, %	2	2	2	2	2	2
Cap, veh/h	69	124	479	1480	1380	84
Arrive On Green	0.12	0.12	0.79	0.79	0.79	0.79
Sat Flow, veh/h	588	1054	670	1870	1745	107
Grp Volume(v), veh/h	163	0	85	525	0	816
Grp Sat Flow(s),veh/h/ln	1651	0	670	1870	0	1851
Q Serve(g_s), s	11.6	0.0	6.5	9.8	0.0	19.8
Cycle Q Clear(g_c), s	11.6	0.0	26.3	9.8	0.0	19.8
Prop In Lane	0.36	0.64	1.00			0.06
Lane Grp Cap(c), veh/h	194	0	479	1480	0	1464
V/C Ratio(X)	0.84	0.00	0.18	0.35	0.00	0.56
Avail Cap(c_a), veh/h	771	0	479	1480	0	1464
HCM Platoon Ratio	1.00	1.00	1.00	1.00	1.00	1.00
Upstream Filter(I)	1.00	0.00	1.00	1.00	0.00	1.00
Uniform Delay (d), s/veh	51.9	0.0	9.6	3.6	0.0	4.7
Incr Delay (d2), s/veh	9.4	0.0	0.8	0.7	0.0	1.5
Initial Q Delay(d3),s/veh	0.0	0.0	0.0	0.0	0.0	0.0
%ile BackOfQ(50%),veh/ln	5.3	0.0	1.0	3.1	0.0	6.2
Unsig. Movement Delay, s/veh						
LnGrp Delay(d),s/veh	61.3	0.0	10.4	4.3	0.0	6.2
LnGrp LOS	E	A	B	A	A	A
Approach Vol, veh/h	163			610	816	
Approach Delay, s/veh	61.3			5.2	6.2	
Approach LOS	E			A	A	
Timer - Assigned Phs		2		4		6
Phs Duration (G+Y+Rc), s		100.4		19.6		100.4
Change Period (Y+Rc), s		5.5		5.5		5.5
Max Green Setting (Gmax), s		53.0		56.0		53.0
Max Q Clear Time (g_c+I1), s		28.3		13.6		21.8
Green Ext Time (p_c), s		4.2		0.5		6.8
Intersection Summary						
HCM 6th Ctrl Delay			11.5			
HCM 6th LOS			B			

**FUTURE “NO-BUILD” INTERSECTION
ANALYSIS**

Intersection						
Int Delay, s/veh	3.7					
Movement	EBT	EBR	WBL	WBT	NBL	NBR
Lane Configurations	↑	↑		↑	↑	↑
Traffic Vol, veh/h	206	37	96	265	54	116
Future Vol, veh/h	206	37	96	265	54	116
Conflicting Peds, #/hr	0	0	0	0	0	0
Sign Control	Free	Free	Free	Free	Stop	Stop
RT Channelized	-	None	-	None	-	None
Storage Length	-	270	-	-	0	30
Veh in Median Storage, #	0	-	-	0	0	-
Grade, %	0	-	-	0	0	-
Peak Hour Factor	90	90	90	90	90	90
Heavy Vehicles, %	2	2	2	2	2	2
Mvmt Flow	229	41	107	294	60	129

Major/Minor	Major1	Major2	Minor1			
Conflicting Flow All	0	0	270	0	737	229
Stage 1	-	-	-	-	229	-
Stage 2	-	-	-	-	508	-
Critical Hdwy	-	-	4.12	-	6.42	6.22
Critical Hdwy Stg 1	-	-	-	-	5.42	-
Critical Hdwy Stg 2	-	-	-	-	5.42	-
Follow-up Hdwy	-	-	2.218	-	3.518	3.318
Pot Cap-1 Maneuver	-	-	1293	-	386	810
Stage 1	-	-	-	-	809	-
Stage 2	-	-	-	-	604	-
Platoon blocked, %	-	-	-	-	-	-
Mov Cap-1 Maneuver	-	-	1293	-	348	810
Mov Cap-2 Maneuver	-	-	-	-	348	-
Stage 1	-	-	-	-	809	-
Stage 2	-	-	-	-	544	-

Approach	EB	WB	NB
HCM Control Delay, s	0	2.1	12.6
HCM LOS			B

Minor Lane/Major Mvmt	NBLn1	NBLn2	EBT	EBR	WBL	WBT
Capacity (veh/h)	348	810	-	-	1293	-
HCM Lane V/C Ratio	0.172	0.159	-	-	0.082	-
HCM Control Delay (s)	17.5	10.3	-	-	8	0
HCM Lane LOS	C	B	-	-	A	A
HCM 95th %tile Q(veh)	0.6	0.6	-	-	0.3	-

Intersection						
Int Delay, s/veh	4.4					
Movement	WBL	WBR	NBT	NBR	SBL	SBT
Lane Configurations	Y		B			A
Traffic Vol, veh/h	22	62	77	14	69	64
Future Vol, veh/h	22	62	77	14	69	64
Conflicting Peds, #/hr	0	0	0	0	0	0
Sign Control	Stop	Stop	Free	Free	Free	Free
RT Channelized	-	None	-	None	-	None
Storage Length	0	-	-	-	-	-
Veh in Median Storage, #	0	-	0	-	-	0
Grade, %	0	-	0	-	-	0
Peak Hour Factor	86	86	86	86	86	86
Heavy Vehicles, %	2	2	2	2	2	2
Mvmt Flow	26	72	90	16	80	74

Major/Minor	Minor1	Major1	Major2			
Conflicting Flow All	332	98	0	0	106	0
Stage 1	98	-	-	-	-	-
Stage 2	234	-	-	-	-	-
Critical Hdwy	6.42	6.22	-	-	4.12	-
Critical Hdwy Stg 1	5.42	-	-	-	-	-
Critical Hdwy Stg 2	5.42	-	-	-	-	-
Follow-up Hdwy	3.518	3.318	-	-	2.218	-
Pot Cap-1 Maneuver	663	958	-	-	1485	-
Stage 1	926	-	-	-	-	-
Stage 2	805	-	-	-	-	-
Platoon blocked, %			-	-		-
Mov Cap-1 Maneuver	626	958	-	-	1485	-
Mov Cap-2 Maneuver	626	-	-	-	-	-
Stage 1	926	-	-	-	-	-
Stage 2	760	-	-	-	-	-

Approach	WB	NB	SB
HCM Control Delay, s	9.8	0	3.9
HCM LOS	A		

Minor Lane/Major Mvmt	NBT	NBRWBLn1	SBL	SBT
Capacity (veh/h)	-	-	841	1485
HCM Lane V/C Ratio	-	-	0.116	0.054
HCM Control Delay (s)	-	-	9.8	7.6
HCM Lane LOS	-	-	A	A
HCM 95th %tile Q(veh)	-	-	0.4	0.2

Timings
3: N. Decatur Rd & Northern Ave

No-Build AM
01/14/2021



Lane Group	EBL	EBT	WBT	SBL
Lane Configurations	↖	↗	↔	↘
Traffic Volume (vph)	44	327	714	24
Future Volume (vph)	44	327	714	24
Lane Group Flow (vph)	47	348	776	147
Turn Type	Perm	NA	NA	Prot
Protected Phases		2	6	4
Permitted Phases	2			
Detector Phase	2	2	6	4
Switch Phase				
Minimum Initial (s)	15.0	15.0	15.0	6.0
Minimum Split (s)	23.5	23.5	23.5	30.5
Total Split (s)	75.0	75.0	75.0	45.0
Total Split (%)	62.5%	62.5%	62.5%	37.5%
Yellow Time (s)	3.5	3.5	3.5	3.5
All-Red Time (s)	2.0	2.0	2.0	2.0
Lost Time Adjust (s)	0.0	0.0	0.0	0.0
Total Lost Time (s)	5.5	5.5	5.5	5.5
Lead/Lag				
Lead-Lag Optimize?				
Recall Mode	C-Min	C-Min	C-Min	None
v/c Ratio	0.08	0.12	0.26	0.63
Control Delay	2.6	2.1	2.5	26.3
Queue Delay	0.0	0.0	0.0	0.0
Total Delay	2.6	2.1	2.5	26.3
Queue Length 50th (ft)	4	17	45	20
Queue Length 95th (ft)	15	37	87	82
Internal Link Dist (ft)		586	931	454
Turn Bay Length (ft)	100			
Base Capacity (vph)	555	2955	2947	621
Starvation Cap Reductn	0	0	0	0
Spillback Cap Reductn	0	0	0	0
Storage Cap Reductn	0	0	0	0
Reduced v/c Ratio	0.08	0.12	0.26	0.24

Intersection Summary

Cycle Length: 120
 Actuated Cycle Length: 120
 Offset: 0 (0%), Referenced to phase 2:EBTL and 6:WBT, Start of Green
 Natural Cycle: 55
 Control Type: Actuated-Coordinated

Splits and Phases: 3: N. Decatur Rd & Northern Ave



HCM 6th Signalized Intersection Summary

3: N. Decatur Rd & Northern Ave

No-Build AM
01/14/2021



Movement	EBL	EBT	WBT	WBR	SBL	SBR
Lane Configurations						
Traffic Volume (veh/h)	44	327	714	15	24	114
Future Volume (veh/h)	44	327	714	15	24	114
Initial Q (Qb), veh	0	0	0	0	0	0
Ped-Bike Adj(A_pbT)	1.00			1.00	1.00	1.00
Parking Bus, Adj	1.00	1.00	1.00	1.00	1.00	1.00
Work Zone On Approach		No	No		No	
Adj Sat Flow, veh/h/ln	1870	1870	1870	1870	1870	1870
Adj Flow Rate, veh/h	47	348	760	16	26	0
Peak Hour Factor	0.94	0.94	0.94	0.94	0.94	0.94
Percent Heavy Veh, %	2	2	2	2	2	2
Cap, veh/h	648	3122	3127	66	51	
Arrive On Green	0.88	0.88	0.88	0.88	0.03	0.00
Sat Flow, veh/h	695	3647	3652	75	1718	0
Grp Volume(v), veh/h	47	348	379	397	27	0
Grp Sat Flow(s),veh/h/ln	695	1777	1777	1857	1784	0
Q Serve(g_s), s	1.3	1.6	4.0	4.0	1.8	0.0
Cycle Q Clear(g_c), s	5.3	1.6	4.0	4.0	1.8	0.0
Prop In Lane	1.00			0.04	0.96	0.00
Lane Grp Cap(c), veh/h	648	3122	1561	1632	53	
V/C Ratio(X)	0.07	0.11	0.24	0.24	0.51	
Avail Cap(c_a), veh/h	648	3122	1561	1632	587	
HCM Platoon Ratio	1.00	1.00	1.00	1.00	1.00	1.00
Upstream Filter(I)	1.00	1.00	1.00	1.00	1.00	0.00
Uniform Delay (d), s/veh	1.5	1.0	1.1	1.1	57.4	0.0
Incr Delay (d2), s/veh	0.2	0.1	0.4	0.4	7.4	0.0
Initial Q Delay(d3),s/veh	0.0	0.0	0.0	0.0	0.0	0.0
%ile BackOfQ(50%),veh/ln	0.1	0.2	0.5	0.5	0.9	0.0
Unsig. Movement Delay, s/veh						
LnGrp Delay(d),s/veh	1.7	1.1	1.5	1.5	64.8	0.0
LnGrp LOS	A	A	A	A	E	
Approach Vol, veh/h		395	776		27	A
Approach Delay, s/veh		1.1	1.5		64.8	
Approach LOS		A	A		E	
Timer - Assigned Phs		2		4		6
Phs Duration (G+Y+Rc), s		110.9		9.1		110.9
Change Period (Y+Rc), s		5.5		5.5		5.5
Max Green Setting (Gmax), s		69.5		39.5		69.5
Max Q Clear Time (g_c+I1), s		7.3		3.8		6.0
Green Ext Time (p_c), s		5.6		0.0		11.8

Intersection Summary

HCM 6th Ctrl Delay	2.8
HCM 6th LOS	A

Notes

User approved volume balancing among the lanes for turning movement.
Unsignalized Delay for [SBR] is excluded from calculations of the approach delay and intersection delay.

Timings
4: N.Indian Creek Dr & Indian Creek Way

No-Build AM
01/14/2021



Lane Group	EBL	NBL	NBT	SBT
Lane Configurations				
Traffic Volume (vph)	69	98	592	268
Future Volume (vph)	69	98	592	268
Lane Group Flow (vph)	149	102	617	425
Turn Type	Prot	Perm	NA	NA
Protected Phases	4		2	6
Permitted Phases		2		
Detector Phase	4	2	2	6
Switch Phase				
Minimum Initial (s)	6.0	15.0	15.0	15.0
Minimum Split (s)	61.5	57.5	57.5	23.5
Total Split (s)	61.5	58.5	58.5	58.5
Total Split (%)	51.3%	48.8%	48.8%	48.8%
Yellow Time (s)	3.5	3.5	3.5	3.5
All-Red Time (s)	2.0	2.0	2.0	2.0
Lost Time Adjust (s)	0.0	0.0	0.0	0.0
Total Lost Time (s)	5.5	5.5	5.5	5.5
Lead/Lag				
Lead-Lag Optimize?				
Recall Mode	None	C-Min	C-Min	C-Min
v/c Ratio	0.67	0.13	0.41	0.30
Control Delay	44.3	3.5	4.7	3.7
Queue Delay	0.0	0.0	0.0	0.0
Total Delay	44.3	3.5	4.7	3.7
Queue Length 50th (ft)	66	14	109	61
Queue Length 95th (ft)	130	35	209	122
Internal Link Dist (ft)	1475		446	669
Turn Bay Length (ft)		50		
Base Capacity (vph)	821	761	1504	1439
Starvation Cap Reductn	0	0	0	0
Spillback Cap Reductn	0	0	0	0
Storage Cap Reductn	0	0	0	0
Reduced v/c Ratio	0.18	0.13	0.41	0.30

Intersection Summary

Cycle Length: 120
 Actuated Cycle Length: 120
 Offset: 0 (0%), Referenced to phase 2:NBTL and 6:SBT, Start of Green
 Natural Cycle: 120
 Control Type: Actuated-Coordinated

Splits and Phases: 4: N.Indian Creek Dr & Indian Creek Way

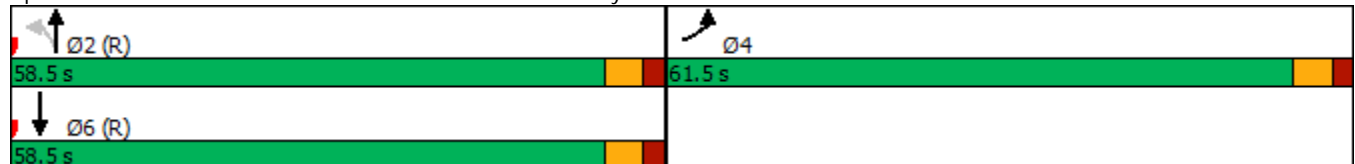

HCM 6th Signalized Intersection Summary

4: N.Indian Creek Dr & Indian Creek Way

No-Build AM
01/14/2021



Movement	EBL	EBR	NBL	NBT	SBT	SBR
Lane Configurations						
Traffic Volume (veh/h)	69	74	98	592	268	140
Future Volume (veh/h)	69	74	98	592	268	140
Initial Q (Qb), veh	0	0	0	0	0	0
Ped-Bike Adj(A_pbT)	1.00	1.00	1.00			1.00
Parking Bus, Adj	1.00	1.00	1.00	1.00	1.00	1.00
Work Zone On Approach	No			No	No	
Adj Sat Flow, veh/h/ln	1870	1870	1870	1870	1870	1870
Adj Flow Rate, veh/h	72	77	102	617	279	146
Peak Hour Factor	0.96	0.96	0.96	0.96	0.96	0.96
Percent Heavy Veh, %	2	2	2	2	2	2
Cap, veh/h	87	93	769	1497	926	484
Arrive On Green	0.11	0.11	0.80	0.80	0.80	0.80
Sat Flow, veh/h	804	860	962	1870	1156	605
Grp Volume(v), veh/h	150	0	102	617	0	425
Grp Sat Flow(s),veh/h/ln	1675	0	962	1870	0	1761
Q Serve(g_s), s	10.5	0.0	3.7	11.8	0.0	7.6
Cycle Q Clear(g_c), s	10.5	0.0	11.3	11.8	0.0	7.6
Prop In Lane	0.48	0.51	1.00			0.34
Lane Grp Cap(c), veh/h	180	0	769	1497	0	1410
V/C Ratio(X)	0.83	0.00	0.13	0.41	0.00	0.30
Avail Cap(c_a), veh/h	782	0	769	1497	0	1410
HCM Platoon Ratio	1.00	1.00	1.00	1.00	1.00	1.00
Upstream Filter(I)	1.00	0.00	1.00	1.00	0.00	1.00
Uniform Delay (d), s/veh	52.5	0.0	4.6	3.6	0.0	3.1
Incr Delay (d2), s/veh	9.4	0.0	0.4	0.8	0.0	0.5
Initial Q Delay(d3),s/veh	0.0	0.0	0.0	0.0	0.0	0.0
%ile BackOfQ(50%),veh/ln	4.9	0.0	0.7	3.6	0.0	2.2
Unsig. Movement Delay, s/veh						
LnGrp Delay(d),s/veh	61.9	0.0	5.0	4.4	0.0	3.7
LnGrp LOS	E	A	A	A	A	A
Approach Vol, veh/h				719	425	
Approach Delay, s/veh				4.5	3.7	
Approach LOS				A	A	
Timer - Assigned Phs		2		4		6
Phs Duration (G+Y+Rc), s		101.6		18.4		101.6
Change Period (Y+Rc), s		5.5		5.5		5.5
Max Green Setting (Gmax), s		53.0		56.0		53.0
Max Q Clear Time (g_c+I1), s		13.8		12.5		9.6
Green Ext Time (p_c), s		5.2		0.5		3.0
Intersection Summary						
HCM 6th Ctrl Delay			10.9			
HCM 6th LOS			B			

Notes

User approved volume balancing among the lanes for turning movement.

Intersection						
Int Delay, s/veh	3					
Movement	EBT	EBR	WBL	WBT	NBL	NBR
Lane Configurations	↑	↗		↖	↖	↗
Traffic Vol, veh/h	257	88	154	300	22	92
Future Vol, veh/h	257	88	154	300	22	92
Conflicting Peds, #/hr	0	0	0	0	0	0
Sign Control	Free	Free	Free	Free	Stop	Stop
RT Channelized	-	None	-	None	-	None
Storage Length	-	270	-	-	0	30
Veh in Median Storage, #	0	-	-	0	0	-
Grade, %	0	-	-	0	0	-
Peak Hour Factor	91	91	91	91	91	91
Heavy Vehicles, %	2	2	2	2	2	2
Mvmt Flow	282	97	169	330	24	101

Major/Minor	Major1	Major2	Minor1		
Conflicting Flow All	0	0	379	0	950 282
Stage 1	-	-	-	-	282 -
Stage 2	-	-	-	-	668 -
Critical Hdwy	-	-	4.12	-	6.42 6.22
Critical Hdwy Stg 1	-	-	-	-	5.42 -
Critical Hdwy Stg 2	-	-	-	-	5.42 -
Follow-up Hdwy	-	-	2.218	-	3.518 3.318
Pot Cap-1 Maneuver	-	-	1179	-	289 757
Stage 1	-	-	-	-	766 -
Stage 2	-	-	-	-	510 -
Platoon blocked, %	-	-	-	-	-
Mov Cap-1 Maneuver	-	-	1179	-	238 757
Mov Cap-2 Maneuver	-	-	-	-	238 -
Stage 1	-	-	-	-	766 -
Stage 2	-	-	-	-	421 -

Approach	EB	WB	NB
HCM Control Delay, s	0	2.9	12.7
HCM LOS			B

Minor Lane/Major Mvmt	NBLn1	NBLn2	EBT	EBR	WBL	WBT
Capacity (veh/h)	238	757	-	-	1179	-
HCM Lane V/C Ratio	0.102	0.134	-	-	0.144	-
HCM Control Delay (s)	21.8	10.5	-	-	8.6	0
HCM Lane LOS	C	B	-	-	A	A
HCM 95th %tile Q(veh)	0.3	0.5	-	-	0.5	-

Intersection						
Int Delay, s/veh	3.7					
Movement	WBL	WBR	NBT	NBR	SBL	SBT
Lane Configurations						
Traffic Vol, veh/h	30	57	67	27	75	141
Future Vol, veh/h	30	57	67	27	75	141
Conflicting Peds, #/hr	0	0	0	0	0	0
Sign Control	Stop	Stop	Free	Free	Free	Free
RT Channelized	-	None	-	None	-	None
Storage Length	0	-	-	-	-	-
Veh in Median Storage, #	0	-	0	-	-	0
Grade, %	0	-	0	-	-	0
Peak Hour Factor	86	86	86	86	86	86
Heavy Vehicles, %	2	2	2	2	2	2
Mvmt Flow	35	66	78	31	87	164

Major/Minor	Minor1	Major1	Major2		
Conflicting Flow All	432	94	0	0	109
Stage 1	94	-	-	-	-
Stage 2	338	-	-	-	-
Critical Hdwy	6.42	6.22	-	-	4.12
Critical Hdwy Stg 1	5.42	-	-	-	-
Critical Hdwy Stg 2	5.42	-	-	-	-
Follow-up Hdwy	3.518	3.318	-	-	2.218
Pot Cap-1 Maneuver	581	963	-	-	1481
Stage 1	930	-	-	-	-
Stage 2	722	-	-	-	-
Platoon blocked, %			-	-	-
Mov Cap-1 Maneuver	543	963	-	-	1481
Mov Cap-2 Maneuver	543	-	-	-	-
Stage 1	930	-	-	-	-
Stage 2	675	-	-	-	-

Approach	WB	NB	SB
HCM Control Delay, s	10.5	0	2.6
HCM LOS	B		

Minor Lane/Major Mvmt	NBT	NBRWBLn1	SBL	SBT
Capacity (veh/h)	-	-	760	1481
HCM Lane V/C Ratio	-	-	0.133	0.059
HCM Control Delay (s)	-	-	10.5	7.6
HCM Lane LOS	-	-	B	A
HCM 95th %tile Q(veh)	-	-	0.5	0.2

Timings
3: N. Decatur Rd & Northern Ave

No-Build PM
01/14/2021



Lane Group	EBL	EBT	WBT	SBL
Lane Configurations	↖	↗↗	↗↖	↘
Traffic Volume (vph)	72	895	397	69
Future Volume (vph)	72	895	397	69
Lane Group Flow (vph)	76	942	454	175
Turn Type	Perm	NA	NA	Prot
Protected Phases		2	6	4
Permitted Phases	2			
Detector Phase	2	2	6	4
Switch Phase				
Minimum Initial (s)	15.0	15.0	15.0	6.0
Minimum Split (s)	23.5	23.5	23.5	30.5
Total Split (s)	77.0	77.0	77.0	43.0
Total Split (%)	64.2%	64.2%	64.2%	35.8%
Yellow Time (s)	3.5	3.5	3.5	3.5
All-Red Time (s)	2.0	2.0	2.0	2.0
Lost Time Adjust (s)	0.0	0.0	0.0	0.0
Total Lost Time (s)	5.5	5.5	5.5	5.5
Lead/Lag				
Lead-Lag Optimize?				
Recall Mode	C-Min	C-Min	C-Min	None
v/c Ratio	0.10	0.34	0.16	0.71
Control Delay	3.9	4.3	3.4	47.7
Queue Delay	0.0	0.0	0.0	0.0
Total Delay	3.9	4.3	3.4	47.7
Queue Length 50th (ft)	11	88	34	86
Queue Length 95th (ft)	30	150	63	154
Internal Link Dist (ft)		586	931	454
Turn Bay Length (ft)	100			
Base Capacity (vph)	724	2806	2775	567
Starvation Cap Reductn	0	0	0	0
Spillback Cap Reductn	0	0	0	0
Storage Cap Reductn	0	0	0	0
Reduced v/c Ratio	0.10	0.34	0.16	0.31

Intersection Summary

Cycle Length: 120
 Actuated Cycle Length: 120
 Offset: 0 (0%), Referenced to phase 2:EBTL and 6:WBT, Start of Green
 Natural Cycle: 55
 Control Type: Actuated-Coordinated

Splits and Phases: 3: N. Decatur Rd & Northern Ave



HCM 6th Signalized Intersection Summary

3: N. Decatur Rd & Northern Ave

No-Build PM
01/14/2021



Movement	EBL	EBT	WBT	WBR	SBL	SBR
Lane Configurations						
Traffic Volume (veh/h)	72	895	397	34	69	97
Future Volume (veh/h)	72	895	397	34	69	97
Initial Q (Qb), veh	0	0	0	0	0	0
Ped-Bike Adj(A_pbT)	1.00			1.00	1.00	1.00
Parking Bus, Adj	1.00	1.00	1.00	1.00	1.00	1.00
Work Zone On Approach		No	No		No	
Adj Sat Flow, veh/h/ln	1870	1870	1870	1870	1870	1870
Adj Flow Rate, veh/h	76	942	418	36	73	0
Peak Hour Factor	0.95	0.95	0.95	0.95	0.95	0.95
Percent Heavy Veh, %	2	2	2	2	2	2
Cap, veh/h	841	3036	2829	243	95	
Arrive On Green	0.85	0.85	0.85	0.85	0.05	0.00
Sat Flow, veh/h	937	3647	3406	284	1758	0
Grp Volume(v), veh/h	76	942	223	231	74	0
Grp Sat Flow(s),veh/h/ln	937	1777	1777	1819	1782	0
Q Serve(g_s), s	1.8	6.3	2.5	2.5	4.9	0.0
Cycle Q Clear(g_c), s	4.3	6.3	2.5	2.5	4.9	0.0
Prop In Lane	1.00			0.16	0.99	0.00
Lane Grp Cap(c), veh/h	841	3036	1518	1554	96	
V/C Ratio(X)	0.09	0.31	0.15	0.15	0.77	
Avail Cap(c_a), veh/h	841	3036	1518	1554	557	
HCM Platoon Ratio	1.00	1.00	1.00	1.00	1.00	1.00
Upstream Filter(I)	1.00	1.00	1.00	1.00	1.00	0.00
Uniform Delay (d), s/veh	1.8	1.7	1.5	1.5	56.0	0.0
Incr Delay (d2), s/veh	0.2	0.3	0.2	0.2	12.0	0.0
Initial Q Delay(d3),s/veh	0.0	0.0	0.0	0.0	0.0	0.0
%ile BackOfQ(50%),veh/ln	0.2	1.1	0.5	0.5	2.5	0.0
Unsig. Movement Delay, s/veh						
LnGrp Delay(d),s/veh	2.0	2.0	1.7	1.7	68.0	0.0
LnGrp LOS	A	A	A	A	E	
Approach Vol, veh/h		1018	454		74	A
Approach Delay, s/veh		2.0	1.7		68.0	
Approach LOS		A	A		E	
Timer - Assigned Phs		2		4		6
Phs Duration (G+Y+Rc), s		108.0		12.0		108.0
Change Period (Y+Rc), s		5.5		5.5		5.5
Max Green Setting (Gmax), s		71.5		37.5		71.5
Max Q Clear Time (g_c+I1), s		8.3		6.9		4.5
Green Ext Time (p_c), s		18.8		0.2		5.9

Intersection Summary

HCM 6th Ctrl Delay	5.1
HCM 6th LOS	A

Notes

User approved volume balancing among the lanes for turning movement.
Unsignalized Delay for [SBR] is excluded from calculations of the approach delay and intersection delay.

Timings
4: N.Indian Creek Dr & Indian Creek Way

No-Build PM
01/14/2021



Lane Group	EBL	NBL	NBT	SBT
Lane Configurations				
Traffic Volume (vph)	58	86	530	776
Future Volume (vph)	58	86	530	776
Lane Group Flow (vph)	166	87	535	832
Turn Type	Prot	Perm	NA	NA
Protected Phases	4		2	6
Permitted Phases		2		
Detector Phase	4	2	2	6
Switch Phase				
Minimum Initial (s)	6.0	15.0	15.0	15.0
Minimum Split (s)	61.5	57.5	57.5	23.5
Total Split (s)	61.5	58.5	58.5	58.5
Total Split (%)	51.3%	48.8%	48.8%	48.8%
Yellow Time (s)	3.5	3.5	3.5	3.5
All-Red Time (s)	2.0	2.0	2.0	2.0
Lost Time Adjust (s)	0.0	0.0	0.0	0.0
Total Lost Time (s)	5.5	5.5	5.5	5.5
Lead/Lag				
Lead-Lag Optimize?				
Recall Mode	None	C-Min	C-Min	C-Min
v/c Ratio	0.68	0.19	0.35	0.55
Control Delay	34.8	4.0	3.9	5.8
Queue Delay	0.0	0.0	0.0	0.0
Total Delay	34.8	4.0	3.9	5.8
Queue Length 50th (ft)	48	11	80	160
Queue Length 95th (ft)	115	33	163	326
Internal Link Dist (ft)	1475		446	669
Turn Bay Length (ft)		50		
Base Capacity (vph)	834	464	1523	1511
Starvation Cap Reductn	0	0	0	0
Spillback Cap Reductn	0	0	0	0
Storage Cap Reductn	0	0	0	0
Reduced v/c Ratio	0.20	0.19	0.35	0.55

Intersection Summary

Cycle Length: 120
 Actuated Cycle Length: 120
 Offset: 0 (0%), Referenced to phase 2:NBTL and 6:SBT, Start of Green
 Natural Cycle: 130
 Control Type: Actuated-Coordinated

Splits and Phases: 4: N.Indian Creek Dr & Indian Creek Way

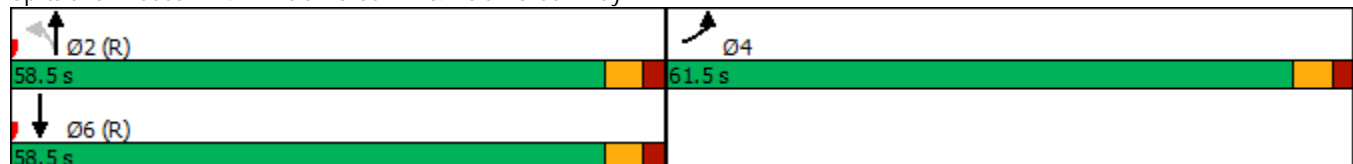

HCM 6th Signalized Intersection Summary
 4: N.Indian Creek Dr & Indian Creek Way

No-Build PM
 01/14/2021



Movement	EBL	EBR	NBL	NBT	SBT	SBR
Lane Configurations						
Traffic Volume (veh/h)	58	106	86	530	776	48
Future Volume (veh/h)	58	106	86	530	776	48
Initial Q (Qb), veh	0	0	0	0	0	0
Ped-Bike Adj(A_pbT)	1.00	1.00	1.00			1.00
Parking Bus, Adj	1.00	1.00	1.00	1.00	1.00	1.00
Work Zone On Approach	No			No	No	
Adj Sat Flow, veh/h/ln	1870	1870	1870	1870	1870	1870
Adj Flow Rate, veh/h	59	107	87	535	784	48
Peak Hour Factor	0.99	0.99	0.99	0.99	0.99	0.99
Percent Heavy Veh, %	2	2	2	2	2	2
Cap, veh/h	70	127	466	1475	1375	84
Arrive On Green	0.12	0.12	0.79	0.79	0.79	0.79
Sat Flow, veh/h	583	1058	660	1870	1744	107
Grp Volume(v), veh/h	167	0	87	535	0	832
Grp Sat Flow(s),veh/h/ln	1651	0	660	1870	0	1851
Q Serve(g_s), s	11.9	0.0	7.0	10.2	0.0	20.7
Cycle Q Clear(g_c), s	11.9	0.0	27.7	10.2	0.0	20.7
Prop In Lane	0.35	0.64	1.00			0.06
Lane Grp Cap(c), veh/h	198	0	466	1475	0	1460
V/C Ratio(X)	0.84	0.00	0.19	0.36	0.00	0.57
Avail Cap(c_a), veh/h	770	0	466	1475	0	1460
HCM Platoon Ratio	1.00	1.00	1.00	1.00	1.00	1.00
Upstream Filter(I)	1.00	0.00	1.00	1.00	0.00	1.00
Uniform Delay (d), s/veh	51.7	0.0	10.2	3.8	0.0	4.9
Incr Delay (d2), s/veh	9.4	0.0	0.9	0.7	0.0	1.6
Initial Q Delay(d3),s/veh	0.0	0.0	0.0	0.0	0.0	0.0
%ile BackOfQ(50%),veh/ln	5.5	0.0	1.1	3.2	0.0	6.6
Unsig. Movement Delay, s/veh						
LnGrp Delay(d),s/veh	61.1	0.0	11.1	4.5	0.0	6.5
LnGrp LOS	E	A	B	A	A	A
Approach Vol, veh/h	167			622	832	
Approach Delay, s/veh	61.1			5.4	6.5	
Approach LOS	E			A	A	
Timer - Assigned Phs		2		4		6
Phs Duration (G+Y+Rc), s		100.1		19.9		100.1
Change Period (Y+Rc), s		5.5		5.5		5.5
Max Green Setting (Gmax), s		53.0		56.0		53.0
Max Q Clear Time (g_c+I1), s		29.7		13.9		22.7
Green Ext Time (p_c), s		4.3		0.6		7.0

Intersection Summary

HCM 6th Ctrl Delay	11.7
HCM 6th LOS	B

Notes

User approved volume balancing among the lanes for turning movement.

FUTURE "BUILD" INTERSECTION ANALYSIS

Intersection						
Int Delay, s/veh	4.1					
Movement	EBT	EBR	WBL	WBT	NBL	NBR
Lane Configurations	↑	↗		↖	↖	↗
Traffic Vol, veh/h	206	40	100	265	64	129
Future Vol, veh/h	206	40	100	265	64	129
Conflicting Peds, #/hr	0	0	0	0	0	0
Sign Control	Free	Free	Free	Free	Stop	Stop
RT Channelized	-	None	-	None	-	None
Storage Length	-	270	-	-	0	30
Veh in Median Storage, #	0	-	-	0	0	-
Grade, %	0	-	-	0	0	-
Peak Hour Factor	90	90	90	90	90	90
Heavy Vehicles, %	2	2	2	2	2	2
Mvmt Flow	229	44	111	294	71	143

Major/Minor	Major1	Major2	Minor1		
Conflicting Flow All	0	0	273	0	745 229
Stage 1	-	-	-	-	229 -
Stage 2	-	-	-	-	516 -
Critical Hdwy	-	-	4.12	-	6.42 6.22
Critical Hdwy Stg 1	-	-	-	-	5.42 -
Critical Hdwy Stg 2	-	-	-	-	5.42 -
Follow-up Hdwy	-	-	2.218	-	3.518 3.318
Pot Cap-1 Maneuver	-	-	1290	-	382 810
Stage 1	-	-	-	-	809 -
Stage 2	-	-	-	-	599 -
Platoon blocked, %	-	-	-	-	-
Mov Cap-1 Maneuver	-	-	1290	-	343 810
Mov Cap-2 Maneuver	-	-	-	-	343 -
Stage 1	-	-	-	-	809 -
Stage 2	-	-	-	-	537 -

Approach	EB	WB	NB
HCM Control Delay, s	0	2.2	13
HCM LOS			B

Minor Lane/Major Mvmt	NBLn1	NBLn2	EBT	EBR	WBL	WBT
Capacity (veh/h)	343	810	-	-	1290	-
HCM Lane V/C Ratio	0.207	0.177	-	-	0.086	-
HCM Control Delay (s)	18.2	10.4	-	-	8.1	0
HCM Lane LOS	C	B	-	-	A	A
HCM 95th %tile Q(veh)	0.8	0.6	-	-	0.3	-

Intersection						
Int Delay, s/veh	4					
Movement	WBL	WBR	NBT	NBR	SBL	SBT
Lane Configurations						
Traffic Vol, veh/h	30	62	100	41	69	71
Future Vol, veh/h	30	62	100	41	69	71
Conflicting Peds, #/hr	0	0	0	0	0	0
Sign Control	Stop	Stop	Free	Free	Free	Free
RT Channelized	-	None	-	None	-	None
Storage Length	0	-	-	-	-	-
Veh in Median Storage, #	0	-	0	-	-	0
Grade, %	0	-	0	-	-	0
Peak Hour Factor	86	86	86	86	86	86
Heavy Vehicles, %	2	2	2	2	2	2
Mvmt Flow	35	72	116	48	80	83

Major/Minor	Minor1	Major1	Major2		
Conflicting Flow All	383	140	0	0	164
Stage 1	140	-	-	-	-
Stage 2	243	-	-	-	-
Critical Hdwy	6.42	6.22	-	-	4.12
Critical Hdwy Stg 1	5.42	-	-	-	-
Critical Hdwy Stg 2	5.42	-	-	-	-
Follow-up Hdwy	3.518	3.318	-	-	2.218
Pot Cap-1 Maneuver	620	908	-	-	1414
Stage 1	887	-	-	-	-
Stage 2	797	-	-	-	-
Platoon blocked, %			-	-	-
Mov Cap-1 Maneuver	583	908	-	-	1414
Mov Cap-2 Maneuver	583	-	-	-	-
Stage 1	887	-	-	-	-
Stage 2	750	-	-	-	-

Approach	WB	NB	SB
HCM Control Delay, s	10.4	0	3.8
HCM LOS	B		

Minor Lane/Major Mvmt	NBT	NBRWBLn1	SBL	SBT
Capacity (veh/h)	-	-	768	1414
HCM Lane V/C Ratio	-	-	0.139	0.057
HCM Control Delay (s)	-	-	10.4	7.7
HCM Lane LOS	-	-	B	A
HCM 95th %tile Q(veh)	-	-	0.5	0.2

Timings
3: N. Decatur Rd & Northern Ave

Build AM
01/14/2021



Lane Group	EBL	EBT	WBT	SBL
Lane Configurations	↖	↗↗	↗↖	↘
Traffic Volume (vph)	47	327	714	31
Future Volume (vph)	47	327	714	31
Lane Group Flow (vph)	50	348	778	165
Turn Type	Perm	NA	NA	Prot
Protected Phases		2	6	4
Permitted Phases	2			
Detector Phase	2	2	6	4
Switch Phase				
Minimum Initial (s)	15.0	15.0	15.0	6.0
Minimum Split (s)	23.5	23.5	23.5	30.5
Total Split (s)	74.0	74.0	74.0	46.0
Total Split (%)	61.7%	61.7%	61.7%	38.3%
Yellow Time (s)	3.5	3.5	3.5	3.5
All-Red Time (s)	2.0	2.0	2.0	2.0
Lost Time Adjust (s)	0.0	0.0	0.0	0.0
Total Lost Time (s)	5.5	5.5	5.5	5.5
Lead/Lag				
Lead-Lag Optimize?				
Recall Mode	C-Min	C-Min	C-Min	None
v/c Ratio	0.09	0.12	0.27	0.67
Control Delay	2.8	2.2	2.6	27.3
Queue Delay	0.0	0.0	0.0	0.0
Total Delay	2.8	2.2	2.6	27.3
Queue Length 50th (ft)	5	18	47	25
Queue Length 95th (ft)	17	39	92	92
Internal Link Dist (ft)		586	931	2806
Turn Bay Length (ft)	100			
Base Capacity (vph)	549	2942	2934	642
Starvation Cap Reductn	0	0	0	0
Spillback Cap Reductn	0	0	0	0
Storage Cap Reductn	0	0	0	0
Reduced v/c Ratio	0.09	0.12	0.27	0.26

Intersection Summary

Cycle Length: 120
 Actuated Cycle Length: 120
 Offset: 0 (0%), Referenced to phase 2:EBTL and 6:WBT, Start of Green
 Natural Cycle: 55
 Control Type: Actuated-Coordinated

Splits and Phases: 3: N. Decatur Rd & Northern Ave

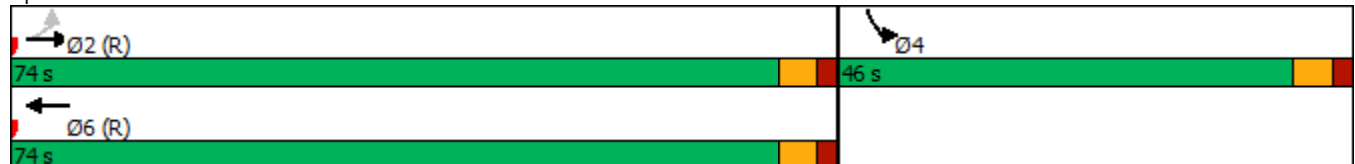

HCM 6th Signalized Intersection Summary

3: N. Decatur Rd & Northern Ave

Build AM
01/14/2021



Movement	EBL	EBT	WBT	WBR	SBL	SBR
Lane Configurations						
Traffic Volume (veh/h)	47	327	714	17	31	124
Future Volume (veh/h)	47	327	714	17	31	124
Initial Q (Qb), veh	0	0	0	0	0	0
Ped-Bike Adj(A_pbT)	1.00			1.00	1.00	1.00
Parking Bus, Adj	1.00	1.00	1.00	1.00	1.00	1.00
Work Zone On Approach		No	No		No	
Adj Sat Flow, veh/h/ln	1870	1870	1870	1870	1870	1870
Adj Flow Rate, veh/h	50	348	760	18	33	0
Peak Hour Factor	0.94	0.94	0.94	0.94	0.94	0.94
Percent Heavy Veh, %	2	2	2	2	2	2
Cap, veh/h	643	3107	3103	73	59	
Arrive On Green	0.87	0.87	0.87	0.87	0.03	0.00
Sat Flow, veh/h	694	3647	3642	84	1731	0
Grp Volume(v), veh/h	50	348	381	397	34	0
Grp Sat Flow(s),veh/h/ln	694	1777	1777	1855	1784	0
Q Serve(g_s), s	1.5	1.6	4.1	4.1	2.3	0.0
Cycle Q Clear(g_c), s	5.6	1.6	4.1	4.1	2.3	0.0
Prop In Lane	1.00			0.05	0.97	0.00
Lane Grp Cap(c), veh/h	643	3107	1554	1622	60	
V/C Ratio(X)	0.08	0.11	0.24	0.25	0.56	
Avail Cap(c_a), veh/h	643	3107	1554	1622	602	
HCM Platoon Ratio	1.00	1.00	1.00	1.00	1.00	1.00
Upstream Filter(I)	1.00	1.00	1.00	1.00	1.00	0.00
Uniform Delay (d), s/veh	1.7	1.0	1.2	1.2	57.1	0.0
Incr Delay (d2), s/veh	0.2	0.1	0.4	0.4	7.9	0.0
Initial Q Delay(d3),s/veh	0.0	0.0	0.0	0.0	0.0	0.0
%ile BackOfQ(50%),veh/ln	0.1	0.2	0.6	0.6	1.1	0.0
Unsig. Movement Delay, s/veh						
LnGrp Delay(d),s/veh	1.9	1.1	1.6	1.6	65.0	0.0
LnGrp LOS	A	A	A	A	E	
Approach Vol, veh/h		398	778		34	A
Approach Delay, s/veh		1.2	1.6		65.0	
Approach LOS		A	A		E	
Timer - Assigned Phs		2		4		6
Phs Duration (G+Y+Rc), s		110.4		9.6		110.4
Change Period (Y+Rc), s		5.5		5.5		5.5
Max Green Setting (Gmax), s		68.5		40.5		68.5
Max Q Clear Time (g_c+I1), s		7.6		4.3		6.1
Green Ext Time (p_c), s		5.7		0.1		11.8

Intersection Summary

HCM 6th Ctrl Delay	3.2
HCM 6th LOS	A

Notes

User approved volume balancing among the lanes for turning movement.
Unsignalized Delay for [SBR] is excluded from calculations of the approach delay and intersection delay.

Timings
4: N.Indian Creek Dr & Indian Creek Way

Build AM
01/14/2021



Lane Group	EBL	NBL	NBT	SBT
Lane Configurations				
Traffic Volume (vph)	86	101	592	268
Future Volume (vph)	86	101	592	268
Lane Group Flow (vph)	178	105	617	430
Turn Type	Prot	Perm	NA	NA
Protected Phases	4		2	6
Permitted Phases		2		
Detector Phase	4	2	2	6
Switch Phase				
Minimum Initial (s)	6.0	15.0	15.0	15.0
Minimum Split (s)	61.5	57.5	57.5	23.5
Total Split (s)	61.5	58.5	58.5	58.5
Total Split (%)	51.3%	48.8%	48.8%	48.8%
Yellow Time (s)	3.5	3.5	3.5	3.5
All-Red Time (s)	2.0	2.0	2.0	2.0
Lost Time Adjust (s)	0.0	0.0	0.0	0.0
Total Lost Time (s)	5.5	5.5	5.5	5.5
Lead/Lag				
Lead-Lag Optimize?				
Recall Mode	None	C-Min	C-Min	C-Min
v/c Ratio	0.70	0.14	0.42	0.31
Control Delay	48.6	4.3	5.7	4.5
Queue Delay	0.0	0.0	0.0	0.0
Total Delay	48.6	4.3	5.7	4.5
Queue Length 50th (ft)	92	16	125	70
Queue Length 95th (ft)	159	41	237	141
Internal Link Dist (ft)	1475		446	669
Turn Bay Length (ft)		50		
Base Capacity (vph)	819	730	1465	1402
Starvation Cap Reductn	0	0	0	0
Spillback Cap Reductn	0	0	0	0
Storage Cap Reductn	0	0	0	0
Reduced v/c Ratio	0.22	0.14	0.42	0.31

Intersection Summary

Cycle Length: 120
 Actuated Cycle Length: 120
 Offset: 0 (0%), Referenced to phase 2:NBTL and 6:SBT, Start of Green
 Natural Cycle: 120
 Control Type: Actuated-Coordinated

Splits and Phases: 4: N.Indian Creek Dr & Indian Creek Way

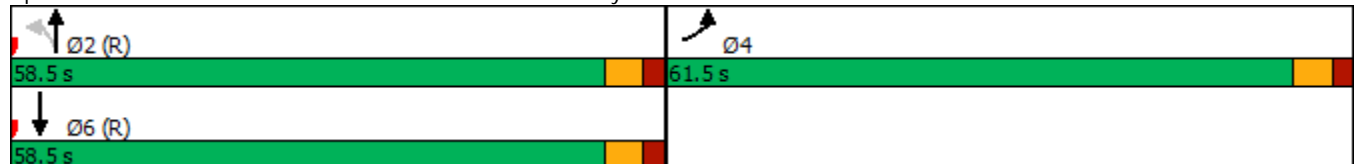

HCM 6th Signalized Intersection Summary

4: N.Indian Creek Dr & Indian Creek Way

Build AM
01/14/2021



Movement	EBL	EBR	NBL	NBT	SBT	SBR
Lane Configurations						
Traffic Volume (veh/h)	86	84	101	592	268	145
Future Volume (veh/h)	86	84	101	592	268	145
Initial Q (Qb), veh	0	0	0	0	0	0
Ped-Bike Adj(A_pbT)	1.00	1.00	1.00			1.00
Parking Bus, Adj	1.00	1.00	1.00	1.00	1.00	1.00
Work Zone On Approach	No			No	No	
Adj Sat Flow, veh/h/ln	1870	1870	1870	1870	1870	1870
Adj Flow Rate, veh/h	90	88	105	617	279	151
Peak Hour Factor	0.96	0.96	0.96	0.96	0.96	0.96
Percent Heavy Veh, %	2	2	2	2	2	2
Cap, veh/h	106	104	743	1464	894	484
Arrive On Green	0.13	0.13	0.78	0.78	0.78	0.78
Sat Flow, veh/h	844	826	958	1870	1141	618
Grp Volume(v), veh/h	179	0	105	617	0	430
Grp Sat Flow(s),veh/h/ln	1680	0	958	1870	0	1759
Q Serve(g_s), s	12.5	0.0	4.2	12.8	0.0	8.4
Cycle Q Clear(g_c), s	12.5	0.0	12.7	12.8	0.0	8.4
Prop In Lane	0.50	0.49	1.00			0.35
Lane Grp Cap(c), veh/h	211	0	743	1464	0	1377
V/C Ratio(X)	0.85	0.00	0.14	0.42	0.00	0.31
Avail Cap(c_a), veh/h	784	0	743	1464	0	1377
HCM Platoon Ratio	1.00	1.00	1.00	1.00	1.00	1.00
Upstream Filter(I)	1.00	0.00	1.00	1.00	0.00	1.00
Uniform Delay (d), s/veh	51.4	0.0	5.6	4.2	0.0	3.7
Incr Delay (d2), s/veh	9.1	0.0	0.4	0.9	0.0	0.6
Initial Q Delay(d3),s/veh	0.0	0.0	0.0	0.0	0.0	0.0
%ile BackOfQ(50%),veh/ln	5.8	0.0	0.8	4.2	0.0	2.6
Unsig. Movement Delay, s/veh						
LnGrp Delay(d),s/veh	60.5	0.0	6.0	5.1	0.0	4.3
LnGrp LOS	E	A	A	A	A	A
Approach Vol, veh/h	179			722	430	
Approach Delay, s/veh	60.5			5.2	4.3	
Approach LOS	E			A	A	
Timer - Assigned Phs		2		4		6
Phs Duration (G+Y+Rc), s		99.4		20.6		99.4
Change Period (Y+Rc), s		5.5		5.5		5.5
Max Green Setting (Gmax), s		53.0		56.0		53.0
Max Q Clear Time (g_c+I1), s		14.8		14.5		10.4
Green Ext Time (p_c), s		5.2		0.6		3.0
Intersection Summary						
HCM 6th Ctrl Delay			12.4			
HCM 6th LOS			B			
Notes						
User approved volume balancing among the lanes for turning movement.						

Intersection						
Int Delay, s/veh	2.1					
Movement	WBL	WBR	NBT	NBR	SBL	SBT
Lane Configurations						
Traffic Vol, veh/h	10	30	82	3	9	75
Future Vol, veh/h	10	30	82	3	9	75
Conflicting Peds, #/hr	0	0	0	0	0	0
Sign Control	Stop	Stop	Free	Free	Free	Free
RT Channelized	-	None	-	None	-	None
Storage Length	0	-	-	-	-	-
Veh in Median Storage, #	0	-	0	-	-	0
Grade, %	0	-	0	-	-	0
Peak Hour Factor	92	92	92	92	92	92
Heavy Vehicles, %	2	2	2	2	2	2
Mvmt Flow	11	33	89	3	10	82

Major/Minor	Minor1	Major1	Major2		
Conflicting Flow All	193	91	0	0	92
Stage 1	91	-	-	-	-
Stage 2	102	-	-	-	-
Critical Hdwy	6.42	6.22	-	-	4.12
Critical Hdwy Stg 1	5.42	-	-	-	-
Critical Hdwy Stg 2	5.42	-	-	-	-
Follow-up Hdwy	3.518	3.318	-	-	2.218
Pot Cap-1 Maneuver	796	967	-	-	1503
Stage 1	933	-	-	-	-
Stage 2	922	-	-	-	-
Platoon blocked, %			-	-	-
Mov Cap-1 Maneuver	790	967	-	-	1503
Mov Cap-2 Maneuver	790	-	-	-	-
Stage 1	933	-	-	-	-
Stage 2	916	-	-	-	-

Approach	WB	NB	SB
HCM Control Delay, s	9.1	0	0.8
HCM LOS	A		

Minor Lane/Major Mvmt	NBT	NBRWBLn1	SBL	SBT
Capacity (veh/h)	-	-	916	1503
HCM Lane V/C Ratio	-	-	0.047	0.007
HCM Control Delay (s)	-	-	9.1	7.4
HCM Lane LOS	-	-	A	A
HCM 95th %tile Q(veh)	-	-	0.1	0

Intersection						
Int Delay, s/veh	1.6					
Movement	WBL	WBR	NBT	NBR	SBL	SBT
Lane Configurations						
Traffic Vol, veh/h	7	20	65	2	6	79
Future Vol, veh/h	7	20	65	2	6	79
Conflicting Peds, #/hr	0	0	0	0	0	0
Sign Control	Stop	Stop	Free	Free	Free	Free
RT Channelized	-	None	-	None	-	None
Storage Length	0	-	-	-	-	-
Veh in Median Storage, #	0	-	0	-	-	0
Grade, %	0	-	0	-	-	0
Peak Hour Factor	92	92	92	92	92	92
Heavy Vehicles, %	2	2	2	2	2	2
Mvmt Flow	8	22	71	2	7	86

Major/Minor	Minor1	Major1	Major2		
Conflicting Flow All	172	72	0	0	73
Stage 1	72	-	-	-	-
Stage 2	100	-	-	-	-
Critical Hdwy	6.42	6.22	-	-	4.12
Critical Hdwy Stg 1	5.42	-	-	-	-
Critical Hdwy Stg 2	5.42	-	-	-	-
Follow-up Hdwy	3.518	3.318	-	-	2.218
Pot Cap-1 Maneuver	818	990	-	-	1527
Stage 1	951	-	-	-	-
Stage 2	924	-	-	-	-
Platoon blocked, %			-	-	-
Mov Cap-1 Maneuver	814	990	-	-	1527
Mov Cap-2 Maneuver	814	-	-	-	-
Stage 1	951	-	-	-	-
Stage 2	919	-	-	-	-

Approach	WB	NB	SB
HCM Control Delay, s	9	0	0.5
HCM LOS	A		

Minor Lane/Major Mvmt	NBT	NBRWBLn1	SBL	SBT
Capacity (veh/h)	-	-	937	1527
HCM Lane V/C Ratio	-	-	0.031	0.004
HCM Control Delay (s)	-	-	9	7.4
HCM Lane LOS	-	-	A	A
HCM 95th %tile Q(veh)	-	-	0.1	0

Intersection						
Int Delay, s/veh	3.3					
Movement	EBT	EBR	WBL	WBT	NBL	NBR
Lane Configurations	↑	↗		↖	↖	↗
Traffic Vol, veh/h	257	98	168	300	28	100
Future Vol, veh/h	257	98	168	300	28	100
Conflicting Peds, #/hr	0	0	0	0	0	0
Sign Control	Free	Free	Free	Free	Stop	Stop
RT Channelized	-	None	-	None	-	None
Storage Length	-	270	-	-	0	30
Veh in Median Storage, #	0	-	-	0	0	-
Grade, %	0	-	-	0	0	-
Peak Hour Factor	91	91	91	91	91	91
Heavy Vehicles, %	2	2	2	2	2	2
Mvmt Flow	282	108	185	330	31	110

Major/Minor	Major1	Major2	Minor1		
Conflicting Flow All	0	0	390	0	982 282
Stage 1	-	-	-	-	282 -
Stage 2	-	-	-	-	700 -
Critical Hdwy	-	-	4.12	-	6.42 6.22
Critical Hdwy Stg 1	-	-	-	-	5.42 -
Critical Hdwy Stg 2	-	-	-	-	5.42 -
Follow-up Hdwy	-	-	2.218	-	3.518 3.318
Pot Cap-1 Maneuver	-	-	1169	-	276 757
Stage 1	-	-	-	-	766 -
Stage 2	-	-	-	-	493 -
Platoon blocked, %	-	-	-	-	-
Mov Cap-1 Maneuver	-	-	1169	-	222 757
Mov Cap-2 Maneuver	-	-	-	-	222 -
Stage 1	-	-	-	-	766 -
Stage 2	-	-	-	-	397 -

Approach	EB	WB	NB
HCM Control Delay, s	0	3.1	13.5
HCM LOS			B

Minor Lane/Major Mvmt	NBLn1	NBLn2	EBT	EBR	WBL	WBT
Capacity (veh/h)	222	757	-	-	1169	-
HCM Lane V/C Ratio	0.139	0.145	-	-	0.158	-
HCM Control Delay (s)	23.8	10.6	-	-	8.7	0
HCM Lane LOS	C	B	-	-	A	A
HCM 95th %tile Q(veh)	0.5	0.5	-	-	0.6	-

Intersection						
Int Delay, s/veh	4					
Movement	WBL	WBR	NBT	NBR	SBL	SBT
Lane Configurations	Y		T			T
Traffic Vol, veh/h	57	57	81	43	75	165
Future Vol, veh/h	57	57	81	43	75	165
Conflicting Peds, #/hr	0	0	0	0	0	0
Sign Control	Stop	Stop	Free	Free	Free	Free
RT Channelized	-	None	-	None	-	None
Storage Length	0	-	-	-	-	-
Veh in Median Storage, #	0	-	0	-	-	0
Grade, %	0	-	0	-	-	0
Peak Hour Factor	86	86	86	86	86	86
Heavy Vehicles, %	2	2	2	2	2	2
Mvmt Flow	66	66	94	50	87	192

Major/Minor	Minor1	Major1	Major2			
Conflicting Flow All	485	119	0	0	144	0
Stage 1	119	-	-	-	-	-
Stage 2	366	-	-	-	-	-
Critical Hdwy	6.42	6.22	-	-	4.12	-
Critical Hdwy Stg 1	5.42	-	-	-	-	-
Critical Hdwy Stg 2	5.42	-	-	-	-	-
Follow-up Hdwy	3.518	3.318	-	-	2.218	-
Pot Cap-1 Maneuver	541	933	-	-	1438	-
Stage 1	906	-	-	-	-	-
Stage 2	702	-	-	-	-	-
Platoon blocked, %			-	-	-	-
Mov Cap-1 Maneuver	504	933	-	-	1438	-
Mov Cap-2 Maneuver	504	-	-	-	-	-
Stage 1	906	-	-	-	-	-
Stage 2	654	-	-	-	-	-

Approach	WB	NB	SB
HCM Control Delay, s	11.9	0	2.4
HCM LOS	B		

Minor Lane/Major Mvmt	NBT	NBRWBLn1	SBL	SBT
Capacity (veh/h)	-	-	654	1438
HCM Lane V/C Ratio	-	-	0.203	0.061
HCM Control Delay (s)	-	-	11.9	7.7
HCM Lane LOS	-	-	B	A
HCM 95th %tile Q(veh)	-	-	0.8	0.2

Timings
3: N. Decatur Rd & Northern Ave

Build PM
01/14/2021



Lane Group	EBL	EBT	WBT	SBL
Lane Configurations	↖	↗	↔	↘
Traffic Volume (vph)	82	895	397	73
Future Volume (vph)	82	895	397	73
Lane Group Flow (vph)	86	942	461	185
Turn Type	Perm	NA	NA	Prot
Protected Phases		2	6	4
Permitted Phases	2			
Detector Phase	2	2	6	4
Switch Phase				
Minimum Initial (s)	15.0	15.0	15.0	6.0
Minimum Split (s)	23.5	23.5	23.5	30.5
Total Split (s)	76.0	76.0	76.0	44.0
Total Split (%)	63.3%	63.3%	63.3%	36.7%
Yellow Time (s)	3.5	3.5	3.5	3.5
All-Red Time (s)	2.0	2.0	2.0	2.0
Lost Time Adjust (s)	0.0	0.0	0.0	0.0
Total Lost Time (s)	5.5	5.5	5.5	5.5
Lead/Lag				
Lead-Lag Optimize?				
Recall Mode	C-Min	C-Min	C-Min	None
v/c Ratio	0.12	0.34	0.17	0.72
Control Delay	4.2	4.5	3.6	48.4
Queue Delay	0.0	0.0	0.0	0.0
Total Delay	4.2	4.5	3.6	48.4
Queue Length 50th (ft)	13	91	36	93
Queue Length 95th (ft)	34	155	66	162
Internal Link Dist (ft)		586	931	2806
Turn Bay Length (ft)	100			
Base Capacity (vph)	714	2786	2751	581
Starvation Cap Reductn	0	0	0	0
Spillback Cap Reductn	0	0	0	0
Storage Cap Reductn	0	0	0	0
Reduced v/c Ratio	0.12	0.34	0.17	0.32

Intersection Summary

Cycle Length: 120
 Actuated Cycle Length: 120
 Offset: 0 (0%), Referenced to phase 2:EBTL and 6:WBT, Start of Green
 Natural Cycle: 55
 Control Type: Actuated-Coordinated

Splits and Phases: 3: N. Decatur Rd & Northern Ave

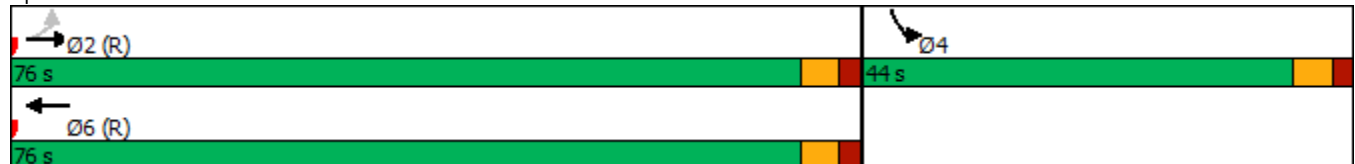

HCM 6th Signalized Intersection Summary

3: N. Decatur Rd & Northern Ave

Build PM
01/14/2021

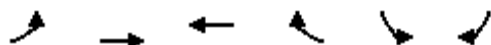

Movement	EBL	EBT	WBT	WBR	SBL	SBR
Lane Configurations						
Traffic Volume (veh/h)	82	895	397	41	73	103
Future Volume (veh/h)	82	895	397	41	73	103
Initial Q (Qb), veh	0	0	0	0	0	0
Ped-Bike Adj(A_pbT)	1.00			1.00	1.00	1.00
Parking Bus, Adj	1.00	1.00	1.00	1.00	1.00	1.00
Work Zone On Approach		No	No		No	
Adj Sat Flow, veh/h/ln	1870	1870	1870	1870	1870	1870
Adj Flow Rate, veh/h	86	942	418	43	77	0
Peak Hour Factor	0.95	0.95	0.95	0.95	0.95	0.95
Percent Heavy Veh, %	2	2	2	2	2	2
Cap, veh/h	832	3026	2771	284	100	
Arrive On Green	0.85	0.85	0.85	0.85	0.06	0.00
Sat Flow, veh/h	931	3647	3348	333	1760	0
Grp Volume(v), veh/h	86	942	227	234	78	0
Grp Sat Flow(s),veh/h/ln	931	1777	1777	1810	1782	0
Q Serve(g_s), s	2.1	6.4	2.6	2.6	5.2	0.0
Cycle Q Clear(g_c), s	4.7	6.4	2.6	2.6	5.2	0.0
Prop In Lane	1.00			0.18	0.99	0.00
Lane Grp Cap(c), veh/h	832	3026	1513	1542	101	
V/C Ratio(X)	0.10	0.31	0.15	0.15	0.77	
Avail Cap(c_a), veh/h	832	3026	1513	1542	572	
HCM Platoon Ratio	1.00	1.00	1.00	1.00	1.00	1.00
Upstream Filter(I)	1.00	1.00	1.00	1.00	1.00	0.00
Uniform Delay (d), s/veh	1.9	1.8	1.5	1.5	55.8	0.0
Incr Delay (d2), s/veh	0.2	0.3	0.2	0.2	11.6	0.0
Initial Q Delay(d3),s/veh	0.0	0.0	0.0	0.0	0.0	0.0
%ile BackOfQ(50%),veh/ln	0.3	1.2	0.5	0.5	2.6	0.0
Unsig. Movement Delay, s/veh						
LnGrp Delay(d),s/veh	2.2	2.1	1.7	1.7	67.4	0.0
LnGrp LOS	A	A	A	A	E	
Approach Vol, veh/h		1028	461		78	A
Approach Delay, s/veh		2.1	1.7		67.4	
Approach LOS		A	A		E	
Timer - Assigned Phs		2		4		6
Phs Duration (G+Y+Rc), s		107.7		12.3		107.7
Change Period (Y+Rc), s		5.5		5.5		5.5
Max Green Setting (Gmax), s		70.5		38.5		70.5
Max Q Clear Time (g_c+I1), s		8.4		7.2		4.6
Green Ext Time (p_c), s		18.9		0.2		6.0

Intersection Summary

HCM 6th Ctrl Delay	5.2
HCM 6th LOS	A

Notes

User approved volume balancing among the lanes for turning movement.

Unsignalized Delay for [SBR] is excluded from calculations of the approach delay and intersection delay.

Timings
4: N.Indian Creek Dr & Indian Creek Way

Build PM
01/14/2021



Lane Group	EBL	NBL	NBT	SBT
Lane Configurations				
Traffic Volume (vph)	68	96	530	776
Future Volume (vph)	68	96	530	776
Lane Group Flow (vph)	182	97	535	850
Turn Type	Prot	Perm	NA	NA
Protected Phases	4		2	6
Permitted Phases		2		
Detector Phase	4	2	2	6
Switch Phase				
Minimum Initial (s)	6.0	15.0	15.0	15.0
Minimum Split (s)	61.5	57.5	57.5	23.5
Total Split (s)	61.5	58.5	58.5	58.5
Total Split (%)	51.3%	48.8%	48.8%	48.8%
Yellow Time (s)	3.5	3.5	3.5	3.5
All-Red Time (s)	2.0	2.0	2.0	2.0
Lost Time Adjust (s)	0.0	0.0	0.0	0.0
Total Lost Time (s)	5.5	5.5	5.5	5.5
Lead/Lag				
Lead-Lag Optimize?				
Recall Mode	None	C-Min	C-Min	C-Min
v/c Ratio	0.71	0.22	0.36	0.57
Control Delay	39.6	5.0	4.5	6.8
Queue Delay	0.0	0.0	0.0	0.0
Total Delay	39.6	5.0	4.5	6.8
Queue Length 50th (ft)	67	14	90	188
Queue Length 95th (ft)	138	42	180	376
Internal Link Dist (ft)	1475		446	669
Turn Bay Length (ft)		50		
Base Capacity (vph)	830	435	1497	1482
Starvation Cap Reductn	0	0	0	0
Spillback Cap Reductn	0	0	0	0
Storage Cap Reductn	0	0	0	0
Reduced v/c Ratio	0.22	0.22	0.36	0.57

Intersection Summary

Cycle Length: 120
 Actuated Cycle Length: 120
 Offset: 0 (0%), Referenced to phase 2:NBTL and 6:SBT, Start of Green
 Natural Cycle: 140
 Control Type: Actuated-Coordinated

Splits and Phases: 4: N.Indian Creek Dr & Indian Creek Way

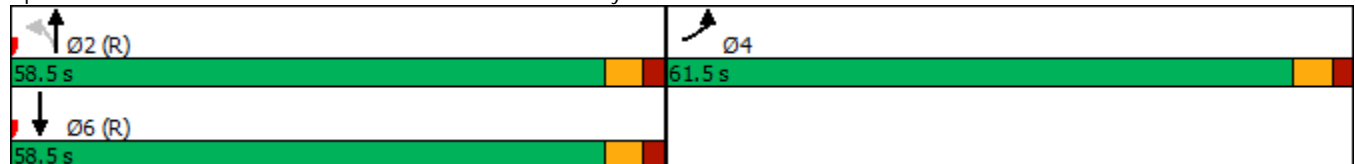

HCM 6th Signalized Intersection Summary

4: N.Indian Creek Dr & Indian Creek Way

Build PM
01/14/2021



Movement	EBL	EBR	NBL	NBT	SBT	SBR
Lane Configurations						
Traffic Volume (veh/h)	68	112	96	530	776	65
Future Volume (veh/h)	68	112	96	530	776	65
Initial Q (Qb), veh	0	0	0	0	0	0
Ped-Bike Adj(A_pbT)	1.00	1.00	1.00			1.00
Parking Bus, Adj	1.00	1.00	1.00	1.00	1.00	1.00
Work Zone On Approach	No			No	No	
Adj Sat Flow, veh/h/ln	1870	1870	1870	1870	1870	1870
Adj Flow Rate, veh/h	69	113	97	535	784	66
Peak Hour Factor	0.99	0.99	0.99	0.99	0.99	0.99
Percent Heavy Veh, %	2	2	2	2	2	2
Cap, veh/h	81	132	442	1456	1325	112
Arrive On Green	0.13	0.13	0.78	0.78	0.78	0.78
Sat Flow, veh/h	624	1022	649	1870	1701	143
Grp Volume(v), veh/h	183	0	97	535	0	850
Grp Sat Flow(s),veh/h/ln	1655	0	649	1870	0	1845
Q Serve(g_s), s	13.0	0.0	8.7	10.6	0.0	22.7
Cycle Q Clear(g_c), s	13.0	0.0	31.4	10.6	0.0	22.7
Prop In Lane	0.38	0.62	1.00			0.08
Lane Grp Cap(c), veh/h	215	0	442	1456	0	1436
V/C Ratio(X)	0.85	0.00	0.22	0.37	0.00	0.59
Avail Cap(c_a), veh/h	772	0	442	1456	0	1436
HCM Platoon Ratio	1.00	1.00	1.00	1.00	1.00	1.00
Upstream Filter(I)	1.00	0.00	1.00	1.00	0.00	1.00
Uniform Delay (d), s/veh	51.1	0.0	11.9	4.1	0.0	5.4
Incr Delay (d2), s/veh	9.2	0.0	1.1	0.7	0.0	1.8
Initial Q Delay(d3),s/veh	0.0	0.0	0.0	0.0	0.0	0.0
%ile BackOfQ(50%),veh/ln	6.0	0.0	1.3	3.5	0.0	7.4
Unsig. Movement Delay, s/veh						
LnGrp Delay(d),s/veh	60.3	0.0	13.0	4.8	0.0	7.2
LnGrp LOS	E	A	B	A	A	A
Approach Vol, veh/h	183			632	850	
Approach Delay, s/veh	60.3			6.1	7.2	
Approach LOS	E			A	A	
Timer - Assigned Phs		2		4		6
Phs Duration (G+Y+Rc), s		98.9		21.1		98.9
Change Period (Y+Rc), s		5.5		5.5		5.5
Max Green Setting (Gmax), s		53.0		56.0		53.0
Max Q Clear Time (g_c+I1), s		33.4		15.0		24.7
Green Ext Time (p_c), s		4.2		0.6		7.1

Intersection Summary

HCM 6th Ctrl Delay	12.6
HCM 6th LOS	B

Notes

User approved volume balancing among the lanes for turning movement.

Intersection						
Int Delay, s/veh	1.9					
Movement	WBL	WBR	NBT	NBR	SBL	SBT
Lane Configurations						
Traffic Vol, veh/h	6	18	69	10	31	95
Future Vol, veh/h	6	18	69	10	31	95
Conflicting Peds, #/hr	0	0	0	0	0	0
Sign Control	Stop	Stop	Free	Free	Free	Free
RT Channelized	-	None	-	None	-	None
Storage Length	0	-	-	-	-	-
Veh in Median Storage, #	0	-	0	-	-	0
Grade, %	0	-	0	-	-	0
Peak Hour Factor	92	92	92	92	92	92
Heavy Vehicles, %	2	2	2	2	2	2
Mvmt Flow	7	20	75	11	34	103

Major/Minor	Minor1	Major1	Major2		
Conflicting Flow All	252	81	0	0	86
Stage 1	81	-	-	-	-
Stage 2	171	-	-	-	-
Critical Hdwy	6.42	6.22	-	-	4.12
Critical Hdwy Stg 1	5.42	-	-	-	-
Critical Hdwy Stg 2	5.42	-	-	-	-
Follow-up Hdwy	3.518	3.318	-	-	2.218
Pot Cap-1 Maneuver	737	979	-	-	1510
Stage 1	942	-	-	-	-
Stage 2	859	-	-	-	-
Platoon blocked, %			-	-	-
Mov Cap-1 Maneuver	719	979	-	-	1510
Mov Cap-2 Maneuver	719	-	-	-	-
Stage 1	942	-	-	-	-
Stage 2	838	-	-	-	-

Approach	WB	NB	SB
HCM Control Delay, s	9.1	0	1.8
HCM LOS	A		

Minor Lane/Major Mvmt	NBT	NBRWBLn1	SBL	SBT
Capacity (veh/h)	-	-	898	1510
HCM Lane V/C Ratio	-	-	0.029	0.022
HCM Control Delay (s)	-	-	9.1	7.4
HCM Lane LOS	-	-	A	A
HCM 95th %tile Q(veh)	-	-	0.1	0.1

Intersection						
Int Delay, s/veh	1.5					
Movement	WBL	WBR	NBT	NBR	SBL	SBT
Lane Configurations						
Traffic Vol, veh/h	4	12	67	7	20	81
Future Vol, veh/h	4	12	67	7	20	81
Conflicting Peds, #/hr	0	0	0	0	0	0
Sign Control	Stop	Stop	Free	Free	Free	Free
RT Channelized	-	None	-	None	-	None
Storage Length	0	-	-	-	-	-
Veh in Median Storage, #	0	-	0	-	-	0
Grade, %	0	-	0	-	-	0
Peak Hour Factor	92	92	92	92	92	92
Heavy Vehicles, %	2	2	2	2	2	2
Mvmt Flow	4	13	73	8	22	88

Major/Minor	Minor1	Major1	Major2		
Conflicting Flow All	209	77	0	0	81
Stage 1	77	-	-	-	-
Stage 2	132	-	-	-	-
Critical Hdwy	6.42	6.22	-	-	4.12
Critical Hdwy Stg 1	5.42	-	-	-	-
Critical Hdwy Stg 2	5.42	-	-	-	-
Follow-up Hdwy	3.518	3.318	-	-	2.218
Pot Cap-1 Maneuver	779	984	-	-	1517
Stage 1	946	-	-	-	-
Stage 2	894	-	-	-	-
Platoon blocked, %			-	-	-
Mov Cap-1 Maneuver	767	984	-	-	1517
Mov Cap-2 Maneuver	767	-	-	-	-
Stage 1	946	-	-	-	-
Stage 2	881	-	-	-	-

Approach	WB	NB	SB
HCM Control Delay, s	9	0	1.5
HCM LOS	A		

Minor Lane/Major Mvmt	NBT	NBRWBLn1	SBL	SBT
Capacity (veh/h)	-	-	919	1517
HCM Lane V/C Ratio	-	-	0.019	0.014
HCM Control Delay (s)	-	-	9	7.4
HCM Lane LOS	-	-	A	A
HCM 95th %tile Q(veh)	-	-	0.1	0

TRAFFIC VOLUME WORKSHEETS

20-147 - Residential Development on Northern Avenue, Dekalb County
Traffic Volumes

A&R Engineering
 January 2021

1. Church St @ Northern Ave

A.M. Peak Hour

Condition	Northern Ave Northbound				- Southbound				Church Street Eastbound				Church Street Westbound			
	L	T	R	Tot	L	T	R	Tot	L	T	R	Tot	L	T	R	Tot
2020 Volumes from 18-120 Project Build:	0	0	0	0	0	0	0	0	0	0	0	0	0	0	0	0
2021 Counts during Covid-19:	31	0	67	98	0	0	0	0	0	119	21	140	55	153	0	208
Adjusted / Projected Existing 2021 Volumes:	53	0	114	167	0	0	0	0	0	202	36	238	94	260	0	354
Growth Factor (%):	1	1	1		1	1	1		1	1	1		1	1	1	
No-Build 2023 Volumes:	54	0	116	170	0	0	0	0	0	206	37	243	96	265	0	361
Total New Trips:	10	0	13	0	0	0	0	0	0	0	3	3	4	0	0	4
Future 2023 Traffic Volumes:	64	0	129	193	0	0	0	0	0	206	40	246	100	265	0	365

P.M. Peak Hour

Condition	Northern Ave Northbound				- Southbound				Church Street Eastbound				Church Street Westbound			
	L	T	R	Tot	L	T	R	Tot	L	T	R	Tot	L	T	R	Tot
2020 Volumes from 18-120 Project Build:	0	0	0	0	0	0	0	0	0	0	0	0	0	0	0	0
2021 Counts during Covid-19:	19	0	78	97	0	0	0	0	0	219	75	294	131	256	0	387
Adjusted / Projected Existing 2021 Volumes:	22	0	90	112	0	0	0	0	0	252	86	338	151	294	0	445
Growth Factor (%):	1	1	1		1	1	1		1	1	1		1	1	1	
No-Build 2023 Volumes:	22	0	92	114	0	0	0	0	0	257	88	345	154	300	0	454
Total New Trips:	6	0	8	0	0	0	0	0	0	0	10	10	14	0	0	14
Future 2023 Traffic Volumes:	28	0	100	128	0	0	0	0	0	257	98	355	168	300	0	468

20-147 - Residential Development on Northern Avenue, Dekalb County
Traffic Volumes

A&R Engineering
 January 2021

2. Northern Ave @ Indian Creek

A.M. Peak Hour

Condition	Northern Ave Northbound				Northern Ave Southbound				- Eastbound				Indian Creek Way Westbound			
	L	T	R	Tot	L	T	R	Tot	L	T	R	Tot	L	T	R	Tot
2020 Volumes from 18-120 Project Build:	0	0	0	0	0	0	0	0	0	0	0	0	0	0	0	0
2021 Counts during Covid-19:	0	44	8	52	40	37	0	77	0	0	0	0	13	0	36	49
Adjusted / Projected Existing 2021 Volumes:	0	75	14	89	68	63	0	131	0	0	0	0	22	0	61	83
Growth Factor (%):	1	1	1		1	1	1		1	1	1		1	1	1	
No-Build 2023 Volumes:	0	77	14	91	69	64	0	133	0	0	0	0	22	0	62	84
Total New Trips:	0	23	27	50	0	7	0	7	0	0	0	0	8	0	0	8
Future 2023 Traffic Volumes:	0	100	41	141	69	71	0	140	0	0	0	0	30	0	62	92

P.M. Peak Hour

Condition	Northern Ave Northbound				Northern Ave Southbound				- Eastbound				Indian Creek Way Westbound			
	L	T	R	Tot	L	T	R	Tot	L	T	R	Tot	L	T	R	Tot
2020 Volumes from 18-120 Project Build:	0	0	0	0	0	0	0	0	0	0	0	0	0	0	0	0
2021 Counts during Covid-19:	0	57	23	80	64	120	0	184	0	0	0	0	25	0	49	74
Adjusted / Projected Existing 2021 Volumes:	0	66	26	92	74	138	0	212	0	0	0	0	29	0	56	85
Growth Factor (%):	1	1	1		1	1	1		1	1	1		1	1	1	
No-Build 2023 Volumes:	0	67	27	94	75	141	0	216	0	0	0	0	30	0	57	87
Total New Trips:	0	14	16	30	0	24	0	24	0	0	0	0	27	0	0	27
Future 2023 Traffic Volumes:	0	81	43	124	75	165	0	240	0	0	0	0	57	0	57	114

20-147 - Residential Development on Northern Avenue, Dekalb County
Traffic Volumes

A&R Engineering
January 2021

3. N. Decatur Rd @ Northern Ave

A.M. Peak Hour

Condition	- Northbound				Northern Ave Southbound				N.Decatur Road Eastbound				N.Decatur Road Westbound			
	L	T	R	Tot	L	T	R	Tot	L	T	R	Tot	L	T	R	Tot
2020 Volumes from 18-120 Project Build:	0	0	0	0	0	0	0	0	0	0	0	0	0	0	0	0
2021 Counts during Covid-19:	0	0	0	0	14	0	66	80	25	189	0	214	0	412	9	421
Adjusted / Projected Existing 2021 Volumes:	0	0	0	0	24	0	112	136	43	321	0	364	0	700	15	715
Growth Factor (%):	1	1	1		1	1	1		1	1	1		1	1	1	
No-Build 2023 Volumes:	0	0	0	0	24	0	114	138	44	327	0	371	0	714	15	729
Total New Trips:	0	0	0	0	7	0	10	17	3	0	0	3	0	0	2	2
Future 2023 Traffic Volumes:	0	0	0	0	31	0	124	155	47	327	0	374	0	714	17	731

P.M. Peak Hour

Condition	- Northbound				Northern Ave Southbound				N.Decatur Road Eastbound				N.Decatur Road Westbound			
	L	T	R	Tot	L	T	R	Tot	L	T	R	Tot	L	T	R	Tot
2020 Volumes from 18-120 Project Build:	0	0	0	0	0	0	0	0	0	0	0	0	0	0	0	0
2021 Counts during Covid-19:	0	0	0	0	59	0	83	142	62	763	0	825	0	338	29	367
Adjusted / Projected Existing 2021 Volumes:	0	0	0	0	68	0	95	163	71	877	0	948	0	389	33	422
Growth Factor (%):	1	1	1		1	1	1		1	1	1		1	1	1	
No-Build 2023 Volumes:	0	0	0	0	69	0	97	166	72	895	0	967	0	397	34	431
Total New Trips:	0	0	0	0	4	0	6	10	10	0	0	10	0	0	7	7
Future 2023 Traffic Volumes:	0	0	0	0	73	0	103	176	82	895	0	977	0	397	41	438

20-147 - Residential Development on Northern Avenue, Dekalb County
Traffic Volumes

A&R Engineering
 January 2021

4. N. Indian @ Indian Creek

A.M. Peak Hour

Condition	N.Indian Creek Dr Northbound				N.Indian Creek Dr Southbound				Indian Creek Way Eastbound				- Westbound			
	L	T	R	Tot	L	T	R	Tot	L	T	R	Tot	L	T	R	Tot
2020 Volumes from 18-120 Project Build:	95	574	0	669	0	260	136	396	67	0	72	139	0	0	0	0
2021 Counts during Covid-19:	0	0	0	0	0	0	0	0	0	0	0	0	0	0	0	0
Adjusted / Projected Existing 2021 Volumes:	96	580	0	676	0	263	137	400	68	0	73	141	0	0	0	0
Growth Factor (%):	1	1	1		1	1	1		1	1	1		1	1	1	
No-Build 2023 Volumes:	98	592	0	690	0	268	140	408	69	0	74	143	0	0	0	0
Total New Trips:	3	0	0	3	0	0	5	5	17	0	10	27	0	0	0	0
Future 2023 Traffic Volumes:	101	592	0	693	0	268	145	413	86	0	84	170	0	0	0	0

P.M. Peak Hour

Condition	N.Indian Creek Dr Northbound				N.Indian Creek Dr Southbound				Indian Creek Way Eastbound				- Westbound			
	L	T	R	Tot	L	T	R	Tot	L	T	R	Tot	L	T	R	Tot
2020 Volumes from 18-120 Project Build:	83	515	0	598	0	753	47	800	56	0	103	159	0	0	0	0
2021 Counts during Covid-19:	0	0	0	0	0	0	0	0	0	0	0	0	0	0	0	0
Adjusted / Projected Existing 2021 Volumes:	84	520	0	604	0	761	47	808	57	0	104	161	0	0	0	0
Growth Factor (%):	1	1	1		1	1	1		1	1	1		1	1	1	
No-Build 2023 Volumes:	86	530	0	616	0	776	48	824	58	0	106	164	0	0	0	0
Total New Trips:	10	0	0	10	0	0	17	17	10	0	6	16	0	0	0	0
Future 2023 Traffic Volumes:	96	530	0	626	0	776	65	841	68	0	112	180	0	0	0	0

20-147 - Residential Development on Northern Avenue, Dekalb County
Traffic Volumes

A&R Engineering
 January 2021

5. Northern Ave @ Drwy 1 (N)

A.M. Peak Hour

Condition	Northern Ave Northbound				Northern Ave Southbound				- Eastbound				Site Driveway 1 (N) Westbound			
	L	T	R	Tot	L	T	R	Tot	L	T	R	Tot	L	T	R	Tot
2020 Volumes from 18-120 Project Build:	0	0	0	0	0	0	0	0	0	0	0	0	0	0	0	0
2021 Counts during Covid-19:	0	36	0	36	0	40	0	40	0	0	0	0	0	0	0	0
Adjusted / Projected Existing 2021 Volumes:	0	61	0	61	0	68	0	68	0	0	0	0	0	0	0	0
Growth Factor (%):	1	1	1		1	1	1		1	1	1		1	1	1	
No-Build 2023 Volumes:	0	62	0	62	0	69	0	69	0	0	0	0	0	0	0	0
Total New Trips:	0	20	3	0	9	6	0	15	0	0	0	0	10	0	30	40
Future 2023 Traffic Volumes:	0	82	3	85	9	75	0	84	0	0	0	0	10	0	30	40

P.M. Peak Hour

Condition	Northern Ave Northbound				Northern Ave Southbound				- Eastbound				Site Driveway 1 (N) Westbound			
	L	T	R	Tot	L	T	R	Tot	L	T	R	Tot	L	T	R	Tot
2020 Volumes from 18-120 Project Build:	0	0	0	0	0	0	0	0	0	0	0	0	0	0	0	0
2021 Counts during Covid-19:	0	49	0	49	0	64	0	64	0	0	0	0	0	0	0	0
Adjusted / Projected Existing 2021 Volumes:	0	56	0	56	0	74	0	74	0	0	0	0	0	0	0	0
Growth Factor (%):	1	1	1		1	1	1		1	1	1		1	1	1	
No-Build 2023 Volumes:	0	57	0	57	0	75	0	75	0	0	0	0	0	0	0	0
Total New Trips:	0	12	10	22	31	20	0	51	0	0	0	0	6	0	18	24
Future 2023 Traffic Volumes:	0	69	10	79	31	95	0	126	0	0	0	0	6	0	18	24

20-147 - Residential Development on Northern Avenue, Dekalb County
Traffic Volumes

A&R Engineering
 January 2021

6. Northern Ave @ Drwy 2 (S)

A.M. Peak Hour

Condition	Northern Ave Northbound				Northern Ave Southbound				- Eastbound				Site Driveway 2 (S) Westbound			
	L	T	R	Tot	L	T	R	Tot	L	T	R	Tot	L	T	R	Tot
2020 Volumes from 18-120 Project Build:	0	0	0	0	0	0	0	0	0	0	0	0	0	0	0	0
2021 Counts during Covid-19:	0	36	0	36	0	40	0	40	0	0	0	0	0	0	0	0
Adjusted / Projected Existing 2021 Volumes:	0	61	0	61	0	68	0	68	0	0	0	0	0	0	0	0
Growth Factor (%):	1	1	1		1	1	1		1	1	1		1	1	1	
No-Build 2023 Volumes:	0	62	0	62	0	69	0	69	0	0	0	0	0	0	0	0
Total New Trips:	0	3	2	5	6	10	0	16	0	0	0	0	7	0	20	27
Future 2023 Traffic Volumes:	0	65	2	67	6	79	0	85	0	0	0	0	7	0	20	27

P.M. Peak Hour

Condition	Northern Ave Northbound				Northern Ave Southbound				- Eastbound				Site Driveway 2 (S) Westbound			
	L	T	R	Tot	L	T	R	Tot	L	T	R	Tot	L	T	R	Tot
2020 Volumes from 18-120 Project Build:	0	0	0	0	0	0	0	0	0	0	0	0	0	0	0	0
2021 Counts during Covid-19:	0	49	0	49	0	64	0	64	0	0	0	0	0	0	0	0
Adjusted / Projected Existing 2021 Volumes:	0	56	0	56	0	74	0	74	0	0	0	0	0	0	0	0
Growth Factor (%):	1	1	1		1	1	1		1	1	1		1	1	1	
No-Build 2023 Volumes:	0	57	0	57	0	75	0	75	0	0	0	0	0	0	0	0
Total New Trips:	0	10	7	17	20	6	0	26	0	0	0	0	4	0	12	16
Future 2023 Traffic Volumes:	0	67	7	74	20	81	0	101	0	0	0	0	4	0	12	16

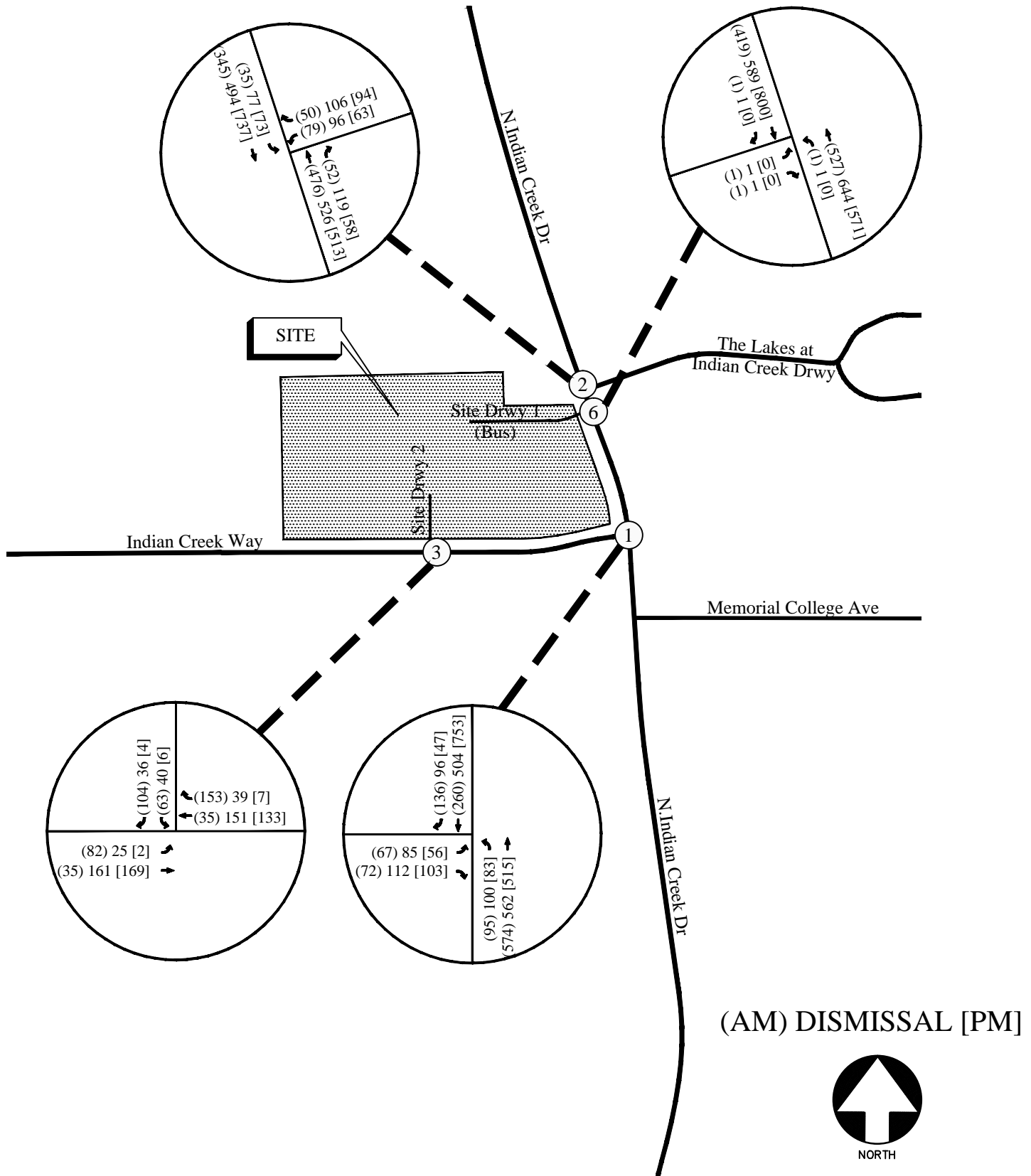

FUTURE (BUILD) WEEKDAY PEAK HOUR VOLUMES

FIGURE 6

A&R Engineering Inc.

18-120 Indian Creek Elementary School - TIS
Traffic Volumes
Future Conditions

A&R Engineering
 October 2018

1. Indian Creek @ Indian Creek

A.M. Peak Hour (7am - 8am)

Condition	N. Indian Creek Drive Northbound				N. Indian Creek Drive Southbound				Indian Creek Way Eastbound				- Westbound			
	L	T	R	Tot	L	T	R	Tot	L	T	R	Tot	L	T	R	Tot
Existing 2018 Volumes:	78	562	0	640	0	250	20	270	89	0	67	156	0	0	0	0
Growth Factor (%):	2	2	2		2	2	2		2	2	2		2	2	2	
No-Build 2020 Volumes:	81	585	0	666	0	260	21	281	93	0	70	163	0	0	0	0
New Car Trips:	3	0	0	3	0	0	22	22	16	0	2	18	0	0	0	0
New Bus Trips:	0	0	0	0	0	0	1	1	1	0	0	1	0	0	0	0
Total New Trips:	3	0	0	3	0	0	23	23	17	0	2	19	0	0	0	0
Redistributed Existing School Trips:	11	-11	0	0	0	0	92	92	-43	0	0	-43	0	0	0	0
Future 2020 Volumes:	95	574	0	669	0	260	136	396	67	0	72	139	0	0	0	0

School Dismissal Peak Hour (2pm - 3pm)

Condition	N. Indian Creek Drive Northbound				N. Indian Creek Drive Southbound				Indian Creek Way Eastbound				- Westbound			
	L	T	R	Tot	L	T	R	Tot	L	T	R	Tot	L	T	R	Tot
Existing 2018 Volumes:	94	541	0	635	0	484	76	560	78	0	107	185	0	0	0	0
Growth Factor (%):	2	2	2		2	2	2		2	2	2		2	2	2	
No-Build 2020 Volumes:	98	563	0	661	0	504	79	583	81	0	111	192	0	0	0	0
New Car Trips:	1	0	0	1	0	0	6	6	7	0	1	8	0	0	0	0
New Bus Trips:	0	0	0	0	0	0	1	1	1	0	0	1	0	0	0	0
Total New Trips:	1	0	0	1	0	0	7	7	8	0	1	9	0	0	0	0
Redistributed Existing School Trips:	1	-1	0	0	0	0	10	10	-4	0	0	-4	0	0	0	0
Future 2020 Volumes:	100	562	0	662	0	504	96	600	85	0	112	197	0	0	0	0

P.M. Peak Hour (4pm - 6pm)

Condition	N. Indian Creek Drive Northbound				N. Indian Creek Drive Southbound				Indian Creek Way Eastbound				- Westbound			
	L	T	R	Tot	L	T	R	Tot	L	T	R	Tot	L	T	R	Tot
Existing 2018 Volumes:	80	495	0	575	0	725	42	767	54	0	98	152	0	0	0	0
Growth Factor (%):	2	2	2		2	2	2		2	2	2		2	2	2	
No-Build 2020 Volumes:	83	515	0	598	0	754	44	798	56	0	102	158	0	0	0	0
New Car Trips:	0	0	0	0	0	0	1	1	1	0	0	1	0	0	0	0
New Bus Trips:	0	0	0	0	0	0	0	0	0	0	0	0	0	0	0	0
Total New Trips:	0	0	0	0	0	0	1	1	1	0	0	1	0	0	0	0
Redistributed Existing School Trips:	0	0	0	0	0	-1	2	1	-1	0	1	0	0	0	0	0
Future 2020 Volumes:	83	515	0	598	0	753	47	800	56	0	103	159	0	0	0	0



DeKalb County Department of Planning & Sustainability

Michael L. Thurmond
Chief Executive Officer

Andrew A. Baker, AICP
Director

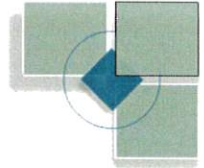

APPLICATION TO AMEND OFFICIAL ZONING MAP OF DEKALB COUNTY, GEORGIA

Z/CZ No. _____

Filing Fee: _____

Date Received: _____ Application No.: _____

Applicant: Inline Communities LLC c/o Battle Law PC E-Mail: mlb@battlelawpc.com

Applicant Mailing Address:
One West Court Square, Suite 750, Decatur GA 30030

Applicant Phone: (404) 601-7616 Fax: (404) 745-0045

Owner(s): Refer to attachment E-Mail: _____
(If more than one owner, attach as Exhibit "A")

Owner's Mailing Address:

Owner(s) Phone: _____ Fax: _____

Address/Location of Subject Property: 671, 657, 635, 655, 649, 641, 631, 623 Northern Ave Clarkston GA 30021

District(s): 18 Land Lot(s): 045 Block: 08 Parcel(s): 095, 001, 008, 003, 005, 006, 007, 004

Acreage: 22.07 Commission District(s): District 4, Super District 6

Present Zoning Category: R-75 & MR-2 Proposed Zoning Category: RSM

Present Land Use Category: Suburban

PLEASE READ THE FOLLOWING BEFORE SIGNING

This form must be completed in its entirety before the Planning Department accepts it. It must include the attachments and filing fees identified on the attachments. An application, which lacks any of the required attachments, shall be determined as incomplete and shall not be accepted.

Disclosure of Campaign Contributions

In accordance with the Conflict of Interest in Zoning Act, O.C.G.A., Chapter 36-67A, the following questions must be answered:

Have you the applicant made \$250 or more in campaign contributions to a local government official within two years immediately preceding the filing of this application? _____ Yes No

If the answer is yes, you must file a disclosure report with the governing authority of DeKalb County showing;

1. The name and official position of the local government official to whom the campaign contribution was made.
2. The dollar amount and description of each campaign contribution made during the two years immediately preceding the filing of this application and the date of each such contribution.

The disclosure must be filed within 10 days after the application is first filed and must be submitted to the C.E.O. and the Board of Commissioners, DeKalb County, 1300 Commerce Drive, Decatur, Ga. 30030.

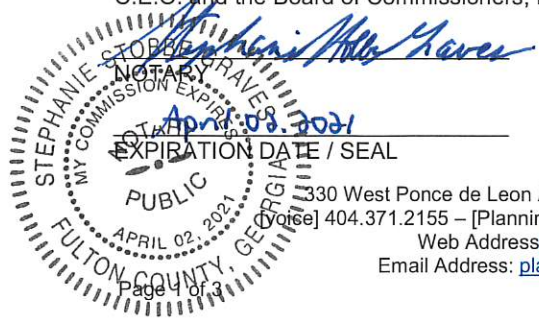

Ben [Signature] 12/16/20
SIGNATURE OF APPLICANT / DATE

Check One: Owner _____ Agent _____



DeKalb County Department of Planning & Sustainability

Michael L. Thurmond
Chief Executive Officer

Andrew A. Baker, AICP
Director

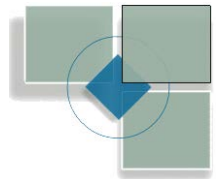

Section 27-832. Standards and factors governing review of proposed amendments to official zoning maps. The following standards and factors are found to be relevant to the exercise of the County's zoning powers and shall govern the review of all proposed amendments to the official zoning maps:

- A. Whether the zoning proposal is in conformity with the policy and intent of the Comprehensive Plan.
- B. Whether the zoning proposal will permit a use that is suitable in view of the use and development of adjacent and nearby properties.
- C. Whether the property to be affected by the zoning proposal has a reasonable economic use as currently zoned.
- D. Whether the zoning proposal will adversely affect the existing use or usability of adjacent or nearby properties.
- E. Whether there are other existing or changing conditions affecting the use and development of the property which give supporting grounds for either approval or disapproval of the zoning proposal.
- F. Whether the zoning proposal will adversely affect historic buildings, sites, districts, or archaeological resources.
- G. Whether the zoning proposal will result in a use which will or could cause excessive or burdensome use of existing streets, transportation facilities, utilities or schools.

Section 27-833. Conditions. Conditions may be requested by an applicant, recommended by the Planning Department and Planning Commission, and imposed by the Board of County Commissioners, as a part of any proposed change to the official zoning map, in accordance with the following requirement:

- A. Conditions may be imposed so as to ameliorate the effect(s) of the proposed developmental change for the protection or benefit of neighboring persons or properties consistent with the purpose and intent of the district(s) involved, and the goals and objectives of the Comprehensive Plan and state law. No condition shall be imposed which reduces the requirements of the district(s) involved. All conditions shall be of sufficient specificity to allow lawful and consistent application and enforcement. All conditions shall be supported by a record that evidences the relationship between the condition in the form of a development exaction for other than a project improvement shall be imposed within the meaning of the Georgia Development Impact Fee Act, as amended.
- B. The Board of Commissioners shall not impose any condition on a proposed amendment to the official zoning map that was not previously reviewed by the Planning Commission unless said condition has been reviewed by the Law Department, Planning Department, and the Public Works Department for legality, enforceability, and recommendation. The Board of County Commissioners may defer final action on any such proposed amendment for up to 60 days to allow for this review and may take action without referral back to the Planning Commission.
- C. Once imposed, conditions shall become an integral part of the approved amendment and shall be enforced as such. Changes to approved conditions shall be authorized only pursuant to Section 27-845 of this chapter.



DeKalb County Department of Planning & Sustainability

Michael L. Thurmond
Chief Executive Officer

Andrew A. Baker, AICP
Director

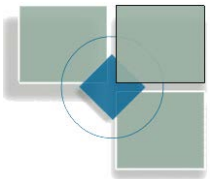

Filing Fees

Filing fees shall not be refunded at any time following the zoning schedule deadline date.

District	Filing Fee
R-200, R-150, R-30, 000, R-20, 000, R-100, R-85 R-75, R-60, TND, R-A5, R-50, R-A8, R-DT, MHP, RM-100, RM-150, CH (4-12 du/acre)	\$500.00
R-200, R-150, R-30, 000, R-20, 000, R-100, R-85, R-75, R-60, R-A8, R-DT, MHP, TND, RM-150, RM-100, RM-85, RM-75, CH, RM-HD, O-I (high-rise apts.) (18 up du/acre)	\$750.00
O-I, O-D, OCR, OIT, NS, CH, C-1, C-2, M, M-2	\$750.00

Applicants requiring more than one zoning district shall be charged the highest of the applicable fee.

Chief Executive Officer
Michael Thurmond

DEPARTMENT OF PLANNING & SUSTAINABILITY

Director
Andrew A. Baker, AICP

PRE-APPLICATION FORM
REZONE, SPECIAL LAND USE PERMIT, MODIFICATION, AND LAND USE
(Required prior to filing application: signed copy of this form must be submitted at filing)

Applicant Name: Inline Communities c/o Battle Law PC Phone: 404.601.7616 Email: mlb@battlelawpc.com

Property Address: 671, 657, 635, 655, 649, 641, 631, 623 Northern Ave, Clarkston GA 30021

Tax Parcel ID: 18 045 08 003 Comm. District(s): District 4, Super District 6 Acreage: 22.07

Existing Use: Suburban Proposed Use: Suburban

Supplemental Regs: No Overlay District: No DRI: No

Rezoning: Yes No

Existing Zoning: R75 and MR2 Proposed Zoning: RSM Square Footage/Number of Units: 151 units

Rezoning Request: Development of 8- rear loaded townhome units, 27 front loaded townhome units, 44 single family detached homes

Land Use Plan Amendment: Yes No

Existing Land Use: SUB Proposed Land Use: Consistent Inconsistent

Special Land Use Permit: Yes No Article Number(s) 27-

Special Land Use Request(s)

Major Modification:

Existing Case Number(s): NA Existing zoning conditions CZ 10 16332 will no longer be effective if Board of Commissioners approves the rezoning

Condition(s) to be modified:

DEPARTMENT OF PLANNING & SUSTAINABILITY

WHAT TO KNOW BEFORE YOU FILE YOUR APPLICATION

Pre-submittal Community Meeting: Review Calendar Dates: PC: 3/2/21* BOC:
3/23/21* Letter of Intent: Impact Analysis: Owner Authorization(s):
Campaign Disclosure: Zoning Conditions: Community Council Meeting: 2/16/21*
Public Notice, Signs: **Applicant must pick up and post** Tree Survey, Conservation: Land
Disturbance Permit (LDP): Sketch Plat: Bldg. Permits: Fire
Inspection: Business License: _____ State License: _____ Lighting Plan: Tent
Permit: _____ Submittal Format: NO STAPLES, NO BINDERS PLEASE

***Assuming the Board of Commissioners adopts the draft 2021 zoning calendar as original proposed.**

Review of Site Plan

Density: 6.84 units/acre Density Bonuses: 4 UPA (BASE) - 8 UPA (DENSITY BONUSSES) 20% Enhanced
Open (2.0upa) / Public Art (0.8 upa)

Mix of Uses: _____ Open Space: 7.47 acres

Enhanced Open Space: 20% ADDITIONAL OF SITE AREA (3.73 ACRES)

Townhome setbacks front: (arterial/local): 20 feet (development)/10 feet (local) side setback (interior): 0 feet (10'
building separation) side corner: 20 feet(development)/ 10 feet (local) rear setback (w/o alley)/(w alley): 15 feet/ 10
feet

Detached housing Setbacks: front 20 feet min/30 feet max sides 3' building separation side corner 20 feet rear
20 feet Lot Size: 20' x 45' townhomes, 24' x 50' townhomes, 60' detached single family lots, 30' x 90'
detached single family lots

Frontage: _____ Street Widths: _____ Landscape Strips: _____ Buffers: _____ Parking Lot
Landscaping: _____ Parking - Auto: 528 spaces (1 garage + 2 driveway space) residential guest parking
- 63 psaces, total parking provided - 591 spaces Parking - Bicycle: _____ Screening: _____
Streetscapes: _____ Sidewalks: _____ Fencing/Walls: _____ Bldg. Height: _____ Bldg. Orientation: _____
Bldg. Separation: _____ Bldg. Materials: _____ Roofs: _____ Fenestration: _____ Façade Design: _____
Garages: _____ Pedestrian Plan: _____ Perimeter Landscape Strip: _____

Possible Variances: Applicant will need to verify compliance with MR-2 zoning standards on site plan
regarding all these issues. Guest parking may count against the maximum parking requirements; a parking
variance may be required if this is the case.

Comments: Density of adjacent apartments will be shown on plan to demonstrate appropriateness of proposed density. Sidewalks
will be provided on plan submitted to Planning Department. Streetscape standards may apply to private driveways, this will be
determined when rezoning application is submitted and under review. Must comply with MR-2 zoning requirements or variances

DEPARTMENT OF PLANNING & SUSTAINABILITY

will be required. Tree survey will be done; removal of specimen trees will require County Arborist approval. Plan appears to comply with perimeter lot compatibility standards of Article 5; will be verified when rezoning application is submitted and under review.

All tax parcel ids that are proposed for rezoning will be listed on the submitted rezoning application to the Planning Department.

Planner: John Reid _____ Date 12/10/20 _____

Filing Fees

REZONING:	RE, RLG, R-100, R-85, R-75, R-60, MHP, RSM, MR-1	\$500.00
	RNC, MR-2, HR-1, HR-2, HR-3, MU-1, MU-2, MU-3, MU-4, MU-5	\$750.00
	OI, OD, OIT, NS, C1, C2, M, M2	\$750.00
LAND USE MAP AMENDMENT		\$500.00
SPECIAL LAND USE PERMIT		\$400.00

Community Meeting Sign-up Sheet and Chat - 655 Northern 12/10

From summer : For those just entering, please add you emails and names. This will constitute as our sign up sheet for the meeting. Feel free to send this to me privately

- Maggie & Scott Nesbit - magsco@gmail.com, scottnesbit@gmail.com
- rita valenti - my phone: 678-328-8725
- Caitlin Thigpen - Caitlin.awalt@gmail.com
- John Short here :) Using Lindsay's zoom
- Nai/GAMVP - naingkokooo@gmail.com
- coopertisdale@hotmail.com. 404-405-8010

Chat:

18:04:09 From summer To Jennifer Kapner(privately) : Thats fine! You can send it to me as well

18:07:31 From summer : For this just entering, please add you emails and names. This will constitute as our sign up sheet for the meeting. Feel free to send this to me privately

18:07:52 From Maggie & Scott Nesbit To summer(privately) : magsco@gmail.com

18:08:00 From Maggie & Scott Nesbit To summer(privately) : maggie scott nesbit

18:08:13 From Maggie & Scott Nesbit To summer(privately) : scottnesbit@gmail.com

18:08:18 From Maggie & Scott Nesbit To summer(privately) : scott j nesbit

18:08:27 From Maggie & Scott Nesbit To summer(privately) : thank you summer

18:09:03 From summer To Maggie & Scott Nesbit(privately) : Thank you Scott and Maggie!

18:20:01 From rita valenti : hand raised please!

18:22:00 From rita valenti : please unmute me!!

18:22:50 From summer To rita valenti(privately) : Hi Rita, if you'd like to send me your question in the chat I can relay it

18:22:54 From rita valenti : they say I'm muted ! Please unmute me

18:23:25 From rita valenti : my hand is raised please unmute me

18:23:27 From Maggie & Scott Nesbit : ok rita i see you too

18:23:45 From summer To rita valenti(privately) : We've unmuted, please make sure your computer is connected to your microphone

18:24:34 From summer : Rita you are unmuted

18:25:06 From rita valenti : I am audio on my phone: 678-328-8725. Please unmute - not on computer

18:26:21 From rita valenti : I am not getting unmute requests! Please unmute 678-328-8725

18:26:44 From rita valenti : I have pressed *6

18:26:51 From summer To rita valenti(privately) : Working to get you the code for your mobile

18:27:38 From summer : in the meantime, Rita please feel free to ask your question in the chat

18:29:33 From Belle Anderson : Sorry I came in late, I have a concern about the noise that will be a part of the construction and how long it will take to complete this construction. I have lived with construction on this site for years and it has been horrible for me on Sandy Woods Lane.

18:30:30 From scott and maggie : thank you, Rita!

18:30:43 From Maggie & Scott Nesbit : yes thank you

18:30:51 From jessjones : RITA FOR THE WIN

18:30:54 From Caitlin Thigpen : Thank you Rita!

18:31:20 From Maggie & Scott Nesbit : also thank you nai and vasav

18:32:57 From rita valenti : The only zoning change was to 657 NORTHERN - for RM85: just one of those properties.

18:34:04 From rita valenti : That's all on Indian Creek Way. And those existing apartments have been here for 30 plus years and are much smaller.

18:35:41 From jessjones : Please don't have an entrance on Creekview.

18:36:10 From Maggie & Scott Nesbit : yes rita

18:36:55 From jessjones : Who's sending Rita drinks after this?

18:38:18 From hibo hussein : great job Rita!!

18:39:51 From KWood : Belle Anderson,

18:40:15 From KWood : Belle Anderson, are you wanting to know the total duration if it were to be approved of construction and building homes?

18:41:32 From Victoria Webb : Usually projects of this magnitude can take years. Only speaking from experience with a 17 acre development near me. Began in 2016, still building out.

18:46:33 From rita valenti : The last developer clear cut the entire property, and then went belly up. Your developers don't even have a track record. The so-called "adjoining" properties are not part of the Northern Avenue and Dial Heights. All this land was dairy many years: the zoning decades ago was totally chaotic. The development you are proposing is to increase density -not conforming to the existing neighbor.

18:48:10 From rita valenti : This area is outside the Clarkston City limits, not surrounded by it. There is absolutely no motion to redevelop the apartments on Indian Creek Way - but if InLine wanted to do that - that would be great.

18:48:43 From rita valenti : There was a deer in my front yard this AM. 660 Northern

18:48:55 From hibo hussein : I agree Rita, those apartments really need to be redeveloped

18:48:58 From Maggie Nesbit : migrate = displaced

18:49:13 From rita valenti : right, Maggie

18:49:24 From jessjones : COMPLETELY agree Scott and Maggie

18:49:42 From Caitlin Thigpen : Thank you both

18:52:51 From hibo hussein : thank you scott!!

18:54:29 From rita valenti : Density and town homes don't necessarily equate to affordable housing.

19:22:28 From Bryan Musolf : Bryan Musolf
19:22:39 From KWood : The wildlife will move during construction but as you have seen all over the city it comes back very quickly after landscaping installed. The buffer area will not be disturbed.
19:22:45 From Bryan Musolf : Bryan Musolf InLine Communities.
bryan@inlinelinecommunities.com
19:22:46 From Maggie Nesbit : yes fran and belle too
19:22:48 From summer : If you all have any questions please feel free to email me at ssw@battlelawpc.com
19:22:59 From Lindsay Short : I wish the developers would consider a conservation community. Would be MUCH more in line with our community.
19:22:59 From jessjones : Fran needs to be able to ask her question
19:23:01 From Belle Anderson : Please also think about those of us who live on the 'boundaries' and when it is approved and we have valid concerns we would like to speak with more than an 'answering machine'
19:23:01 From Maggie Nesbit : please share chat with all of us
19:23:08 From scott and maggie : exactly Lindsay!
19:23:17 From Caitlin Thigpen : I downloaded it Maggie
19:23:19 From Victoria Webb : Thank you everyone.
19:23:21 From Caitlin Thigpen : I can email to you
19:23:32 From Lindsay Short : John Short here :) Using Lindsay's zoom
19:23:32 From summer : for access to the chat and zoom meeting email me a request at ssw@battlelawpc.com
19:23:43 From Maggie Nesbit : yes please sharw
19:23:48 From Caitlin Thigpen : John say hey to Lindsay for me!
19:23:48 From Maggie Nesbit : thank you
19:23:57 From Batoya Clements : Batoya Clements - bdc@battlelawpc.com
19:24:04 From Nai/GAMVP : will we get a copy of the map???
19:24:14 From scott and maggie : thanks so much to MICHELLE!!!
19:24:18 From summer : Yes we can share a copy of the site plan
19:24:36 From Nai/GAMVP : please do - naingkokooo@gmail.com or streetwide please
19:25:01 From iPad (2) To summer(privately) : coopertisdale@hotmail.com. 404-405-8010
19:25:13 From summer : it would be helpful for those requesting information to send me an email at ssw@battlelawpc.com
19:25:14 From Belle Anderson : I would like a copy of the site plan. I think we all would. Thanks again.
19:25:52 From Cooper Sanchez : someone needs to change the battery one their fire alarm. do not sleep on this issue. I don't know how you could.
19:26:43 From iPad (2) To summer(privately) : I think it was you that asked for our info directly.
19:26:46 From Maggie Nesbit : thanks y'all! best night to you

LETTER OF INTENT AND IMPACT ANALYSIS

As Required by

City of South Fulton, Georgia Zoning Ordinance

For

Rezoning Application pursuant to
the Dekalb County Zoning Ordinance

by

Inline Communities LLC (the “Applicant”)

For

22.07 acres of land located at

671, 657, 635, 655, 649, 641, 631, 623 Northern Ave Clarkston GA 30021

Submitted for Applicant by:

Michèle L. Battle

Battle Law, P.C.

One West Court Square, Suite 750

Decatur, Georgia 30030

(404) 601-7616 Phone

(404) 745-0045 Facsimile mlb@battlelawpc.com

Statement of Intent and Impact Analysis

The applicant, Inline Communities LLC is seeking to develop 22.07 acres at 671, 657, 635, 655, 649, 641, 631, 623 Northern Ave Clarkston GA 30021 (collectively, the "Subject Property") for the development of 151 residential units for a Residential Community Development. The Subject Property is currently zoned R-75 and MR-2 with a land use designation of Suburban. The applicant is seeking to rezone to the Subject Property to Small Lot Residential Mix (RSM) to allow for 6.84 units per acre.

This document is submitted as the Letter of Application regarding this Application, and a preservation of the Applicant's constitutional rights. A surveyed plat and site plan of the Subject Property has been filed contemporaneously with the Application, along with other required materials.

IMPACT ANALYSIS

1. Does the zoning proposal permit a use that is suitable in view of the use and development of adjacent and nearby property?

The Subject Property is currently zoned R-75 and MR-2. It is adjacent to properties zoned MR-2 allowing for 18 units per acre and R-75 allowing for 8 units per acre in a land use designated Suburban. The proposed rezoning to RSM at 12 units per acre is consistent with the Suburban land use designation and will harmonious with the surrounding properties and introduce a mix of living options, it will provide for new homes owners in the area on a currently underdeveloped lot. The anticipated price points on the homes be equal to or greater than the surrounding home values, which will help support the existing home values in the area, supporting the continued growth and development of area.

2. Does the zoning proposal adversely affect the existing use or usability of adjacent or nearby property?

The proposed rezoning to RSM will not adversely affect the existing use or usability of adjacent or nearby property. The proposed rezoning will support the continued growth and development of the surrounding area.

3. Does the property to be rezoned have a reasonable economic use as currently zoned?

The Subject Property has no reasonable economic use as currently zoned R 75 and MR2 with conditions as a private school. The property has been on the market for sale for an excess of 10 years. The current zoning conditions severely restrict the use of the property to a non-residential private school which is a specialized use with no marketability outside of private school operators.

4. Will the zoning proposal result in a use that could cause an excessive or burdensome use of existing streets, transportation facilities, utilities or schools?

Located on Northern Ave, there is the possibility for an increase of traffic on the existing street. The Applicant aims to provide a traffic assessment and perform modifications that will lessen the traffic congestion originating from the development along Northern Avenue. With respect to the public schools in the area, at 165 units per acre, there should not a substantial increase of students who would attend one of the three public schools in the area. The tax dollars generated by the Subject Property as well as the other subdivision coming into the area, provides an opportunity for the expansion of existing facilities.

5. Is the zoning proposal in conformity with the policies and intent of the land use plan?

The South Fulton Comprehensive Land Use Map shows the Subject Property as having a land use designation of Suburban. The RSM zoning designation is a permitted and in conformity with the Suburban designation.

6. Are there existing or changing conditions that affect the use and development of the property which support either approval or denial of the zoning proposal?

With the approved rezoning to RSM of The Subject Property, we aim to create two entrance points for The Subject Property, have building maximum height of 45', promote pedestrian connectivity throughout the property, have a mix of single and multi-family units that is harmonious in scale, provides flexibility of design, and provides usable amenity spaces, with no additional conditions or variances applied to the Subject Property.

7. Does the zoning proposal permit a use that can be considered environmentally adverse to the natural resources, environment and citizens of City of South Fulton?

The rezoning will not permit any use that can be considered environmentally adverse to the natural resources, environment and citizens of the Dekalb County which is not typical of development projects. It will include a 75' stream buffer and two water detention ponds adjacent to the flood zone and aims to keep natural wooded areas at the west-end of the property.

NOTICE OF CONSTITUTIONAL ALLEGATIONS AND PRESERVATION OF CONSTITUTIONAL RIGHTS

The portions of the DeKalb County Zoning Ordinance, facially and as applied to the Subject Property, which restrict or classify or may restrict or classify the Subject Property so as to prohibit its development as proposed by the Applicant are or would be unconstitutional in that they would destroy the Applicant's property rights without first paying fair, adequate and just compensation for such rights, in violation of the Fifth Amendment and Fourteenth Amendment of the Constitution of the United States and Article I, Section I, Paragraph I of the Constitution of the State of Georgia of 1983, Article I, Section III, Paragraph I of the Constitution of the State of Georgia of 1983, and would be in violation of the Commerce Clause, Article I, Section 8, Clause 3 of the Constitution of the United States.

The application of the DeKalb County Zoning Ordinance to the Subject Property which restricts its use to any classification other than that proposed by the Applicant is unconstitutional, illegal, null and void, constituting a taking of Applicant's Property in violation of the Just Compensation Clause of the Fifth Amendment to the Constitution of the United States, Article I, Section I, Paragraph I, and Article I, Section III, Paragraph I of the Constitution of the State of Georgia of 1983, and the Equal Protection and Due Process Clauses of the Fourteenth Amendment to the Constitution of the United States denying the Applicant an economically viable use of its land while not substantially advancing legitimate state interests.

A denial of this Application would constitute an arbitrary irrational abuse of discretion and unreasonable use of the zoning power because they bear no substantial relationship to the public health, safety, morality or general welfare of the public and substantially harm the Applicant in violation of the due process and equal protection rights guaranteed by the Fifth Amendment and Fourteenth Amendment of the Constitution of the United States, and Article I, Section I, Paragraph I and Article I, Section III, Paragraph 1 of the Constitution of the State of Georgia.

A refusal by the DeKalb County Board of Commissioners to rezone the Subject Property to the classification as requested by the Applicant would be unconstitutional and discriminate in an arbitrary, capricious and unreasonable manner between the Applicant and owners of similarly situated property in violation of Article I, Section I, Paragraph II of the Constitution of the State of Georgia of 1983 and the Equal Protection Clause of the Fourteenth Amendment to the Constitution of the United States. Any rezoning of the Property subject to conditions which are different from the conditions requested by the Applicant, to the extent such different conditions would have the effect of further restricting Applicant's utilization of the property, would also constitute an arbitrary, capricious and discriminatory act in zoning the Subject Property to an unconstitutional classification and would likewise violate each of the provisions of the State and Federal Constitutions set forth hereinabove.

A refusal to allow the rezoning in questions would be unjustified from a fact-based standpoint and instead would result only from constituent opposition, which would be an unlawful delegation of authority in violation of Article IX, Section II, Paragraph IV of the Georgia Constitution.

A refusal to allow the rezoning in question would be invalid in as much as it would be denied pursuant to an ordinance which is not in compliance with the Zoning Procedures Law, O.C.G.A. Section 36-66/1 et seq., due to the manner in which the Ordinance as a whole and its map(s) have been adopted.

The existing zoning classification on the Subject Property is unconstitutional as it applies to the Subject Property. This notice is being given to comply with the provisions of O.C.G.A. Section 36-11-1 to afford the County an opportunity to revise the Property to a constitutional classification. If action is not taken by the County to rectify this unconstitutional zoning classification within a reasonable time, the Applicant is hereby placing the County on notice that it may elect to file a claim in the Superior Court of DeKalb County demanding just and adequate compensation under Georgia law for the taking of the Subject Property, diminution of value of the Subject Property, attorney's fees and other damages arising out of the unlawful deprivation of the Applicant's property rights.

ZONING DESCRIPTION

ALL THAT TRACT OR PARCEL OF LAND lying and being in Land Lots 44, 45 and 66 of the 18th District, DeKalb County, Georgia and being more particularly described as follows:

To find the TRUE POINT OF BEGINNING, commence from a point, at the intersection of the easterly right-of-way line of Northern Avenue (50' R/W) and the Land Lot Line common to Land Lots 45 and 66; thence along said right-of-way line 117.33 feet along an arc of a curve to the right, said curve having a radius of 644.97 feet and a chord bearing and distance of South 5 degrees 19 minutes 0 seconds East 117.17 feet to a point and the TRUE POINT OF BEGINNING; thence leaving said right-of-way line South 89 degrees 32 minutes 2 seconds East a distance of 195.06 feet to a point; thence North 0 degrees 19 minutes 33 seconds East a distance of 117.09 feet to a point; thence South 89 degrees 40 minutes 43 seconds East a distance of 754.46 feet to a point; thence North 38 degrees 57 minutes 2 seconds East a distance of 161.35 feet to a point; thence North 89 degrees 14 minutes 14 seconds East a distance of 135.98 feet to a point; thence South 19 degrees 36 minutes 47 seconds East a distance of 637.19 feet to a point; thence South 23 degrees 15 minutes 51 seconds East a distance of 271.01 feet to a point; thence North 88 degrees 54 minutes 34 seconds West a distance of 777.54 feet to a point; thence North 89 degrees 10 minutes 23 seconds West a distance of 737.54 feet to a point on said right-of-way line; thence along said right-of-way line the following courses and distances: North 0 degrees 8 minutes 46 seconds West a distance of 217.32 feet to a point; thence North 01 degree 4 minutes 44 seconds East a distance of 367.94 feet to a point to a point and the TRUE POINT OF BEGINNING.

Said tract containing 22.351 acres, more or less.

Campaign Contribution Disclosure Statements

CAMPAIGN CONTRIBUTIONS DISCLOSURE STATEMENT

Pursuant to the provisions of 36 O.C.G.A. 67(A), please find below a list of those contributions made by Michèle L. Battle or Battle Law, P.C. in the past two years, aggregating \$250.00 or more, to local government officials who will consider this application.

NAME OF GOV'T OFFICIAL	OFFICIAL POSITION	AMOUNT OF CONTRIBUTION
Kathie Gannon	Commissioner	\$350
Mereda Davis Johnson	Commissioner	\$500
Larry Johnson	Commissioner	\$700
Lorraine Cochran-Johnson	Commissioner	\$250

By: 
Printed Name: Michèle BATTLE

Chief Executive Officer
Michael Thurmond

DEPARTMENT OF PLANNING & SUSTAINABILITY

Director
Andrew A. Baker, AICP

REZONE APPLICATION AUTHORIZATION

Completion of this form is required if the individual making the request is **not** the owner of the property.

DATE: 12/8/2020

CHECK TYPE OF APPLICATION:

- () LAND USE PLAN
- (x) REZONE
- () MINOR MODIFICATION

TO WHOM IT MAY CONCERN:

(I) (WE), FUGEES LAND HOLDINGS LLC
(Name of owner(s))

being (owner)/(owners) of the property described below or attached hereby delegate authority to

Inline Communities LLC c/o Battle Law PC

(Name of Applicant or Agent Representing Owner)
to file an application on my/our behalf.

[Signature]
Notary Public

FUGEES LAND HOLDINGS LLC
[Signature]
Owner

Notary Public

Owner

Notary Public

Owner

Chief Executive Officer
Michael Thurmond

DEPARTMENT OF PLANNING & SUSTAINABILITY

Director
Andrew A. Baker, AICP

REZONE APPLICATION AUTHORIZATION

Completion of this form is required if the individual making the request is not the owner of the property.

DATE: 12/8/2020

CHECK TYPE OF APPLICATION:

- LAND USE PLAN
- REZONE
- MINOR MODIFICATION

TO WHOM IT MAY CONCERN:

(I) (WE), GRANDHIGE, ANJALI
(Name of owner(s))

being (owner)/(owners) of the property described below or attached hereby delegate authority to

Inline Communities LLC c/o Battle Law PC

(Name of Applicant or Agent Representing Owner)

to file an application on (my) / (our) behalf.

Linda M. Brannan
Notary Public

GRANDHIGE, ANJALI
Owner

Notary Public

Owner

Notary Public

Owner



Chief Executive Officer
Michael Thurmond

DEPARTMENT OF PLANNING & SUSTAINABILITY

Director
Andrew A. Baker, AICP

REZONE APPLICATION AUTHORIZATION

Completion of this form is required if the individual making the request is **not** the owner of the property.

DATE: 12/8/2020

CHECK TYPE OF APPLICATION:

- LAND USE PLAN
- REZONE
- MINOR MODIFICATION

TO WHOM IT MAY CONCERN:

(I) (WE), GRANDHIGE, HEMANTH
(Name of owner(s))

being (owner)/(owners) of the property described below or attached hereby delegate authority to

Inline Communities LLC c/o Battle Law PC

(Name of Applicant or Agent Representing Owner)

to file an application on (my) / (our) behalf.

Linda M. Brannan
Notary Public

Notary Public

Notary Public

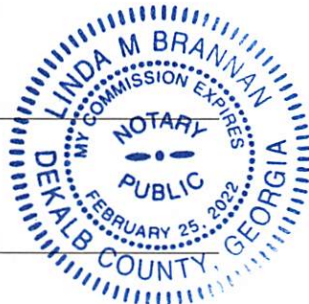

GRANDHIGE, HEMANTH
Owner

Owner

Owner

