



DeKalb County Department of Planning & Sustainability

178 Sams Street,
Decatur, GA 30030
(404) 371-2155 / www.dekalbcountyga.gov/planning

Planning Commission Hearing Date: March 7, 2023
Board of Commissioners Hearing Date: March 30, 2023

STAFF ANALYSIS

Case No.:	Z-22-1246092	Agenda #: 2022-2262
Location/Address:	1065 Fayetteville Road	Commission District: 03 Super District: 06
Parcel ID(s):	15-147-07-001	
Request:	Rezone from the O-I (Office Institutional) Zoning District to RSM (Small Lot Residential Mix) Zoning District to allow the construction of single-family attached townhomes.	
Property Owner(s):	Beasley Family Towers, LLC	
Applicant/Agent:	Toll Brothers, Inc. c/o Kathryn M. Zickert-Smith, Gambrell and Russell, LLP	
Acreage:	17.2 acres	
Existing Land Use:	Utilities	
Surrounding Properties:	North: R-75 East: R-75 South: City of Atlanta West: MR-2 (across I-20)	
Comprehensive Plan:	SUB <input checked="" type="checkbox"/> Consistent	<input type="checkbox"/> Inconsistent

Staff Recommendation: 30-day deferral.

The applicant is requesting a rezoning from the O-I (Office Institutional) Zoning District to the RSM (Small Lot Residential Mix) Zoning District for development of a 102-unit (fee simple) townhome community. The requested rezoning to RSM is consistent with the *Comprehensive Plan*. The subject property is located in the Suburban (SUB) future land use character area, which includes RSM as a permissible zoning district (pg. 116) and lists “townhomes” as a primary land use (pg. 115).

The proposed zoning appears to be suitable based on its surroundings. Interstate 20 (I-20) abuts the subject property to the west. The proposal provides a reasonable land use transition from the interstate to nearby single-family, detached residential uses north and east of the subject property. Moreover, the subject property would be within 300 feet of another RSM zoned townhome development (*Collection at East Lake*). From a wider viewpoint, the subject property would add to the desired pattern of moderate density zoning (e.g., MR-2, RSM, and MR-1) along the I-20 corridor.

The applicant is requesting a density bonus of two (2) dwelling units per acre (2DUs/acre) for the maximum density allowed within RSM of six (6) dwelling units per acre (6DUs/acre). In exchange for the density bonus, the applicant proffers the installation of a pocket park, a dog park, and a

greenway/pedestrian trail as enhanced open space. A variance is required for stream buffer encroachment for pedestrian trail network.

The Board of Commissioners, at its November 17, 2022 zoning meeting, deferred the request for two cycles based on the following issues: lack of details regarding stormwater management; access; proposed encroachment into the Sugar Creek floodplain; and community concerns about suitability, fire safety, flooding, and soil composition. Some of the outstanding issues raised have been addressed. The revised site plan removes all residential lots from the floodplain. A larger swath of dedicated open space for a pocket park is included. A linear greenway is proposed at the center of the development. Other revisions include a reduction in unit size. Sixty-one (61) townhome units are proposed to be 15 feet wide. Homes along Graham Circle will face the right-of-way and contain rear-loaded garages.

While improved since its initial presentation, the proposal still has some challenges and will require a number of variances from the Zoning Board of Appeals. The project proposes individual, fee-simple, townhomes, but compliance with applicable setbacks for each individual lot is incomplete. Additionally, minimum lot width for single-family, attached units is 25 feet. 15-foot-wide lots may be considered by the Zoning Board of Appeals, assuming there is a demonstrated physical hardship on-site that requires zoning relief. The proposed retaining wall height may also be subject to variance approval. Details regarding stormwater management are absent. Lastly, two access points are proposed with one full access ingress/egress at Fayetteville Road and an emergency only access on Graham Circle. Graham Circle is a narrow street with on-street parking, however, use of only one access may pose internal circulation and traffic issues. Insight from transportation staff has been requested.

Based upon review of Section 7.3.5. (D, E, G, and H) of the *Zoning Ordinance*, staff recommends a 30-day deferral for further consideration and refinement of this proposal. The applicant recently submitted revised plans (see attached), but Staff has not had time to review those revised plans.

DEPARTMENT OF PLANNING & SUSTAINABILITY

Rezoning Application to Amend the Official Zoning Map of DeKalb County, Georgia

Date Received: _____ Application No: _____

Applicant Name: Toll Brothers, Inc. c/o Kathryn M. Zickert-Smith, Gambrell and Russell, LLP

Applicant E-Mail Address: kzickert@sgrlaw.com

Applicant Mailing Address: 1105 West Peachtree Street, N.E., Suite 1000, Atlanta, Georgia 30309

Applicant Daytime Phone: 404-815-3704 Fax: 404-685-7004

Owner Name: Beasley Family Towers, LLC

If more than one owner, attach list of owners.

Owner Mailing Address: 3033 Riviera Drive, #200, Naples, Florida 34103-2750

Owner Daytime Phone: _____

Address of Subject Property: 1065 Fayetteville Road, Atlanta, Georgia 30316

Parcel ID#: 15 147 07 001

Acreage: 17.2 ac

Commission District: 3, 6

Present Zoning District(s): O-I

Proposed Zoning District: RSM

Present Land Use Designation: Suburban (Walkable Neighborhoods)

Proposed Land Use Designation (if applicable): N/A

REZONING APPLICATION CHECKLIST

Submit 4 printed, collated sets of the complete application (no staples, no binders) and a PDF version on a flash drive

1. Schedule a mandatory **Pre-Application Conference** with Planning & Sustainability staff by appointment. Obtain **Pre-Application form** (to be completed in pre-application meeting). Please call 404-371-2155 for appointment.

2. Hold a **Pre-Submittal Community Meeting** with surrounding neighborhood associations and residents. Provide documentation of the meeting (**meeting notice and sign in sheets**). Letter(s) from homeowners association(s) may also be provided.

3. Submit **Application** (Submit 4 printed, collated sets and a PDF version on a flash drive. Please assemble materials in the following order.)

A. Application form with name and address of applicant and owner, and address of subject property;

B. Pre-submittal community meeting notice and sign-in sheet and other documentation of meeting, if any;

C. Letter of application and impact analysis

1. **Letter of application** identifying a) the proposed zoning classification, b) the reason for the rezoning or special use or modification request, c) the existing and proposed use of the property, d) detailed characteristics of the proposed use (e.g. floor area, height of building(s), number of units, mix of unit types, number of employees, manner and hours of operation), d)(optional) statement of conditions discussed with the neighborhood or community, if any.
2. **Impact analysis** of the anticipated impact of the proposed use and rezoning on the surrounding properties in response to the standards and factors specified in Article 7.3 of the DeKalb County Zoning Ordinance, as attached. If a Major Modification, please include previously approved conditions and Board of Commissioner meeting minutes.

D. Authorization Form, if applicant is not the owner. Must be signed by all owners of the subject property and notarized. Authorization must contain the mailing address and phone number of any applicant or agent who is authorized to represent the owner(s) of the subject property. Please include warranty deed, if property ownership is less than 2 years.

E. Campaign disclosure statement (required by State law).

F. Legal boundary survey of the subject property, (showing boundaries, structures, and improvements), prepared and sealed within the last year by a professional engineer or land surveyor registered in the State of Georgia. *(If survey shows property on opposite sides of a public street right-of-way, file a separate application for each property.)*

G. Site Plan, printed to scale, folded, of any existing and or proposed development/redevelopment. For projects larger than 1 acre, site plan should be at least 1:50 scale. The site plan must include the following:

a. complete boundaries of subject property;

b. dimensioned access points and vehicular circulation drives;

c. location of all existing and proposed buildings, structures, setbacks and parking;

d. location of 100 year floodplain and any streams;

e. notation of the total acreage or square footage of the subject property;

f. landscaping, tree removal and replacement, buffer(s); and

g. site plan notes of building square footages, heights, density calculations, lot coverage of impervious surfaces, parking ratios, open space calculations, and other applicable district standards.

H. Reduced Site Plan, reduced to 8.5" x 11".

I. Written Legal Description of metes and bounds of the subject property (can be printed on site plan or survey).

J. Building Form Information. Elevation (line drawing or rendering), or details of proposed materials, in compliance with Article 5 of the Zoning Ordinance.

K. Completed, signed Pre-application Form (Provided at pre-application meeting.)

INCOMPLETE APPLICATIONS WILL NOT BE ACCEPTED

DEPARTMENT OF PLANNING & SUSTAINABILITY

IMPACT ANALYSIS

(Please respond to the following standards and factors on a separate sheet.)

Section 27-7.3.5. The following standards and factors are found to be relevant to the exercise of the county's zoning powers and shall govern the review of all proposed amendments to the Official Zoning Map:

- A. Whether the zoning proposal is in conformity with the policy and intent of the Comprehensive Plan.
- B. Whether the zoning proposal will permit a use that is suitable in view of the use and development of adjacent and nearby properties.
- C. Whether the property to be affected by the zoning proposal has a reasonable economic use as currently zoned.
- D. Whether the zoning proposal will adversely affect the existing use or usability of adjacent or nearby properties.
- E. Whether there are other existing or changing conditions affecting the use and development of the property which give supporting grounds for either approval or disapproval of the zoning proposal.
- F. Whether the zoning proposal will adversely affect historic building, sites, districts, or archaeological resources.
- G. Whether the zoning proposal will result in a use which will or could cause excessive or burdensome use of existing streets, transportation facilities, utilities, or schools.
- H. Whether the zoning proposal adversely impacts the environment or surrounding natural resources.

DEPARTMENT OF PLANNING & SUSTAINABILITY

AUTHORIZATION

The property owner should complete this form or a similar signed and notarized form if the individual who will file the application with the County is not the property owner.

Date: _____

TO WHOM IT MAY CONCERN:

(I) (WE) Beasley Family Towers, LLC

Name of owner(s)

being (owner) (owners) of the subject property described below or attached hereby delegate authority to

Kathryn M. Zickert, Smith, Gambrell & Russell, LLP

Name of Agent or Representative

to file an application on (my) (our) behalf.

Jerrine C. Flowers
Notary Public



Notary Public

Candice Beasley
Owner Beasley Family Towers, LLC

Owner

Notary Public

Owner

Notary Public

Owner

DEPARTMENT OF PLANNING & SUSTAINABILITY

DISCLOSURE OF CAMPAIGN CONTRIBUTION

In accordance with the Conflict of Interest in Zoning Act, OCGA Chapter 36-67A, the following questions must be answered.

Have you, the applicant, made \$250.00 or more in campaign contribution to a local government official within two years immediately preceding the filing of this application?

Yes _____ No _____ *

If the answer is yes, you must file a disclosure report with the governing authority of DeKalb County showing:

1. The name and official position of the local government official to whom the campaign contribution was made.
2. The dollar amount and description of each campaign contribution made during the two years immediately preceding the filing of this application and the date of each such contribution.

The disclosure must be filed within 10 days after the application is first filed and must be submitted to the C.E.O. and to the Board of Commissioners of DeKalb County, 1300 Commerce Drive, Decatur, GA 30030.



Notary



Expiration Date/ Seal



Signature of Applicant /Date
Beasley Family Towers, LLC
Check one: Owner Agent _____

*Notary seal not needed if answer is "no".

DEPARTMENT OF PLANNING & SUSTAINABILITY

DISCLOSURE OF CAMPAIGN CONTRIBUTION

In accordance with the Conflict of Interest in Zoning Act, OCGA Chapter 36-67A, the following questions must be answered.

Have you, the applicant, made \$250.00 or more in campaign contribution to a local government official within two years immediately preceding the filing of this application?

Yes _____ No *

If the answer is yes, you must file a disclosure report with the governing authority of DeKalb County showing:

1. The name and official position of the local government official to whom the campaign contribution was made.
2. The dollar amount and description of each campaign contribution made during the two years immediately preceding the filing of this application and the date of each such contribution.

The disclosure must be filed within 10 days after the application is first filed and must be submitted to the C.E.O. and to the Board of Commissioners of DeKalb County, 1300 Commerce Drive, Decatur, GA 30030.

Notary



Signature of Applicant /Date

Toll Brothers

Check one: Owner _____ Applicant X

Expiration Date/ Seal

*Notary seal not needed if answer is "no".

DEPARTMENT OF PLANNING & SUSTAINABILITY

DISCLOSURE OF CAMPAIGN CONTRIBUTION

In accordance with the Conflict of Interest in Zoning Act, OCGA Chapter 36-67A, the following questions must be answered.

Have you, the applicant, made \$250.00 or more in campaign contribution to a local government official within two years immediately preceding the filling of this application?

Yes X No _____*

If the answer is yes, you must file a disclosure report with the governing authority of DeKalb County showing:

1. The name and official position of the local government official to whom the campaign contribution was made.
2. The dollar amount and description of each campaign contribution made during the two years immediately preceding the filing of this application and the date of each such contribution.

The disclosure must be filed within 10 days after the application is first filed and must be submitted to the C.E.O. and to the Board of Commissioners of DeKalb County, 1300 Commerce Drive, Decatur, GA 30030.

Cathy M. Ellington
Notary



Expiration Date/Seal

Dennis J. Webb, Jr.
Signature of Applicant /Date

Check one: Owner _____ Agent X

*Notary seal not needed if answer is "no".

DEPARTMENT OF PLANNING & SUSTAINABILITY

DISCLOSURE OF CAMPAIGN CONTRIBUTION

In accordance with the Conflict of Interest in Zoning Act, OCGA Chapter 36-67A, the following questions must be answered.

Have you, the applicant, made \$250.00 or more in campaign contribution to a local government official within two years immediately preceding the filing of this application?

Yes X No _____*

If the answer is yes, you must file a disclosure report with the governing authority of DeKalb County showing:

1. The name and official position of the local government official to whom the campaign contribution was made.
2. The dollar amount and description of each campaign contribution made during the two years immediately preceding the filing of this application and the date of each such contribution.

The disclosure must be filed within 10 days after the application is first filed and must be submitted to the C.E.O. and to the Board of Commissioners of DeKalb County, 1300 Commerce Drive, Decatur, GA 30030.

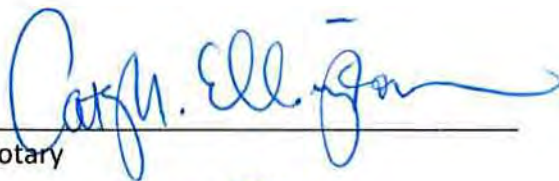

Notary

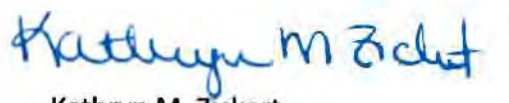

Kathryn M. Zickert
Signature of Applicant /Date

Check one: Owner _____ Agent X



Expiration Date/Seal

*Notary seal not needed if answer is "no".

DEPARTMENT OF PLANNING & SUSTAINABILITY

DISCLOSURE OF CAMPAIGN CONTRIBUTION

In accordance with the Conflict of Interest in Zoning Act, OCGA Chapter 36-67A, the following questions must be answered.

Have you, the applicant, made \$250.00 or more in campaign contribution to a local government official within two years immediately preceding the filing of this application?

Yes _____ No X *

If the answer is yes, you must file a disclosure report with the governing authority of DeKalb County showing:

1. The name and official position of the local government official to whom the campaign contribution was made.
2. The dollar amount and description of each campaign contribution made during the two years immediately preceding the filing of this application and the date of each such contribution.

The disclosure must be filed within 10 days after the application is first filed and must be submitted to the C.E.O. and to the Board of Commissioners of DeKalb County, 1300 Commerce Drive, Decatur, GA 30030.



J. Alexander Brock

Signature of Applicant /Date

Notary

Check one: Owner _____ Agent X

Expiration Date/ Seal

*Notary seal not needed if answer is "no".

1105 W. Peachtree St. NE, Suite 1000
Atlanta, Georgia 30309-3608
Tel: 404 815-3500
www.sgrlaw.com



J. Alexander Brock
Direct Tel: 404-815-3603
Direct Fax: 404-685-6903
jabrock@sgrlaw.com

August 30, 2022

Via Email: bhsander@dekalbcountyga.gov

ATTN: Barbara Sanders-Norwood
DeKalb County Board of Commissioners
1300 Commerce Drive
Decatur, Georgia 30030

This letter is intended to provide campaign contributions as required by state law for Kathryn M. Zickert, Dennis J. Webb, Jr., J. Alexander Brock and Smith, Gambrell & Russell, LLP. This information is being provided in conjunction with the Rezoning application that will be filed for the property at 1065 Fayetteville Road. Please be advised that over the past two years (2020-2022) our total contributions have been as follows:

Jan. 2021 Robert Patrick \$500.00 [Kathryn M. Zickert]
June 2021 Robert Patrick \$500.00 [Kathryn M. Zickert]
April 2022 Friends of Larry Johnson for \$1,000.00 [SGR-PAC]
April 2022 Michelle for DeKalb for \$2,000.00 (Michelle Long Spears) [SGR-PAC]
April 2022 Friends of Lorraine Johnson for \$1,000.00 [SGR-PAC]
April 2022 Friends of Lorraine Johnson for \$500.00 [Kathryn M. Zickert]
April 2022 Friends of Lorraine Johnson for \$500.00 [Dennis J. Webb, Jr.]
April 2022 Michelle for DeKalb for \$500.00 (Michelle Long Spears) [Dennis J. Webb, Jr.]
June 2022 Michelle for DeKalb for \$1,600 (Michelle Long Spears) [SGR-PAC]
June 2022 Michelle for DeKalb for \$500 (Michelle Long Spears) [Dennis J. Webb, Jr.]
June 2022 Michelle for DeKalb for \$250 (Michelle Long Spears) [Dennis J. Webb, Jr.]
August 2022 Michelle for DeKalb for \$500 (Michelle Long Spears) [Dennis J. Webb, Jr.]

Please let me know if you require any additional information.

Sincerely,

A handwritten signature in blue ink that reads "J. Alexander Brock".

J. Alexander Brock

Pre-Application Meeting



404.371.2155 (o)
404.371.4556 (f)
DeKalbCountyGa.gov

Clark Harrison Building
330 W. Ponce de Leon Ave
Decatur, GA 30030

Chief Executive Officer
Michael Thurmond

DEPARTMENT OF PLANNING & SUSTAINABILITY

Director
Andrew A. Baker, AICP

**PRE-APPLICATION FORM
REZONE, SPECIAL LAND USE PERMIT, MODIFICATION, AND LAND USE
(Required prior to filing application: signed copy of this form must be submitted at filing)**

Applicant Name: Alex Brock et al. Phone: 404-815-3603 Email: jabrock@sgrlaw.com

Property Address: 1065 Fayetteville Rd., Atlanta, GA 30316

Tax Parcel ID: 15-147-07-001 Comm. District(s): 3 & 6 Acreage: 17.13 acres

Existing Use: 2 cell towers Proposed Use: townhome development

Supplemental Regs: _____ Overlay District: N/A DRI: TBD

Rezoning: Yes No _____

Existing Zoning: O-I Proposed Zoning: RSM Square Footage/Number of Units: 104

Rezoning Request: Site will require a rezoning to accommodate the request.

Land Use Plan Amendment: Yes _____ No

Existing Land Use: SUB Proposed Land Use: _____ Consistent Inconsistent _____

Special Land Use Permit: Yes _____ No _____ Article Number(s) 27- _____

Special Land Use Request(s) _____

Major Modification:

Existing Case Number(s): _____

Condition(s) to be modified:

DEPARTMENT OF PLANNING & SUSTAINABILITY

WHAT TO KNOW BEFORE YOU FILE YOUR APPLICATION

Pre-submittal Community Meeting: 8/30/22 Review Calendar Dates: X PC: BOC: X
 Letter of Intent: X Impact Analysis: X Owner Authorization(s): Campaign Disclosure:
 Zoning Conditions: X Community Council Meeting: X Public Notice, Signs: X Tree Survey, Conservation: X Land Disturbance Permit (LDP): X Sketch Plat: X Bldg. Permits: X Fire Inspection: X Business License: State License: Lighting Plan: Tent Permit: Submittal Format: NO STAPLES, NO BINDERS PLEASE

Review of Site Plan

Density: 6-8DU/ac Density Bonuses: Yes, enhanced open space (walking trail, pocket park, outdoor gathering area) Mix of Uses: NO Open Space: 20% Enhanced Open Space: Yes Setbacks: front sides side corner rear Lot Size: Frontage: Street Widths: private Landscape Strips: yes Buffers: yes Parking Lot Landscaping: Parking - Auto: driveways Parking - Bicycle: Screening: Streetscapes: yes Sidewalks: yes Fencing/Walls: perimeter Bldg. Height: 37ft. Bldg. Orientation: internal Bldg. Separation: Bldg. Materials: board & batten, some brick Roofs: Fenestration: Façade Design: Garages: 80-90% of front facade Pedestrian Plan: will do Perimeter Landscape Strip:
 Possible Variances:

Comments:

Planner: Brandon White Date 8/23/2022

Filing Fees

REZONING:	RE, RLG, R-100, R-85, R-75, R-60, MHP, RSM, MR-1	\$500.00
	RNC, MR-2, HR-1, HR-2, HR-3, MU-1, MU-2, MU-3, MU-4, MU-5	\$750.00
	OI, OD, OIT, NS, C1, C2, M, M2	\$750.00

LAND USE MAP AMENDMENT \$500.00

DEPARTMENT OF PLANNING & SUSTAINABILITY

SPECIAL LAND USE PERMIT

\$400.00

Public Notification & Community Meeting

1105 W. Peachtree St. NE, Suite 1000
Atlanta, Georgia 30309-3608
Tel: 404 815-3500
www.sgrlaw.com



Kathryn M. Zickert
Direct Tel: 404-815-3704
Direct Fax: 404-685-7004
kzickert@sgrlaw.com

August 5, 2022

Re: Petitioner: Toll Brothers, Inc. (Kathryn M. Zickert)
Subject: Community Meeting Notice

Dear Neighbor,

You are receiving this notice because you own property within 500' of 1065 Fayetteville Road, (the "Subject Property"). The Petitioner is seeking a Rezoning to allow for the development of 104 townhomes. It will need a Rezoning to accomplish this goal.

You are invited to participate in a Community Meeting on the proposal on Tuesday, August 30, 2022 at 7:00 PM at the Gresham Library located at 2418 Gresham Road, SE, Atlanta, Georgia 30316 (404.244.4374). The application has not been filed yet so we do not know the public process dates as yet.

The Special Land Use Permit application will be presented at the DeKalb County Planning Commission and the Board of Commissioners at a future date. Further details on these meetings (including whether the hearings will be live or virtual) will be made available on the County's website: www.dekalbcountyga.gov.

Should you have any questions regarding this application, please feel free to contact me.

With kind regards,

A handwritten signature in blue ink that reads "Kathryn M Zickert".

Kathryn M. Zickert

cc: Jake Meek
Luke Geckeler

PROPERTY OWNER NOTIFICATION LIST

Property Owner	Address	
PRESLEY RENEE	2173 LEFFERTS PL	ATLANTA GA 30316
WILLIAMS CHELSEA MIA	2153 LEFFERTS PL	ATLANTA GA 30316
O DWYER PROPERTIES LLC	850 OLD ALPHARETTA RD	ALPHARETTA GA 30005
O DWYER PROPERTIES LLC	850 OLD ALPHARETTA RD	ALPHARETTA GA 30005
GATES AT FLAT SHOALS LLC	325 MONTEVALLO DR	ATLANTA GA 30342
GREGORY RUSSELL	2164 LEFFERTS PL	ATLANTA GA 30316
VEGA EDUARDO ALBERTO EMIR VALLEJO	2168 LEFFERTS PL	ATLANTA GA 30316
MORGAN LOIS ELAINE	2042 BENCAL DR SE	ATLANTA GA 30316
CORDIA GEORGIA 2 LLC	2727 LBJ FREEWAY 806	DALLAS TX 75234
SMITH JAMES	2072 BENCAL DR SE	ATLANTA GA 30316
ECHOLS RUSSELL ECHOLS STACEY	850 FAYETTEVILLE RD SE	ATLANTA GA 30316
CHRIS 180 SUPPORT ORGANIZATION INC	1017 FAYETTEVILLE RD STE B	ATLANTA GA 30316
GREATER PINEY GROVE BAPTIST	1879 GLENWOOD AVE SE	ATLANTA GA 30316
FORSTER EVAN	2172 LEFFERTS PL	ATLANTA GA 30316
HOUSTON DAVID W	860 GLENWOOD BCH APT 534	ATLANTA GA 30316
O DWYER PROPERTIES LLC	850 OLD ALPHARETTA RD	ALPHARETTA GA 30005
WHATLEY VICTORIA E	2166 LEFFERTS PL	ATLANTA GA 30316
CHRIS PROPERTIES GRAHAM	1017 FAYETTEVILLE RD STE B	ATLANTA GA 30316
ORR TIKIRA LYGETTE	11408 88TH AVENUE CT SW	LAKEWOOD WA 98498
DEKALB COUNTY	1300 COMMERCE DR	DECATUR GA 30030
CARTER GUS JR	2083 BENCAL DR SE	ATLANTA GA 30316
COFER JESSIE M	2037 BENCAL DR SE	ATLANTA GA 30316
FAYETTEVILLE RD CHURCH OF GOD	1003 FAYETTEVILLE RD SE	ATLANTA GA 30316
FB FLAT SHOALS ROAD LLC	4145 POWELL RD	POWELL OH 43065
KALMACHLANDE JETTA	139 PINETREE CIR	DECATUR GA 30032
HOLLOWAY ARTHUR W	196 SOUTH AVE SE	ATLANTA GA 30315
LEE TERENCE LENARD	2151 LEFFERTS PL	ATLANTA GA 30316
FLETCHER MIKKO	2147 LEFFERTS PL	ATLANTA GA 30316
LUNDBERG ALEXANDER	1100 TALIWA TRL NE	MARIETTA GA 30068
GUTHRIE AUDREY J	2071 BENCAL DR SE	ATLANTA GA 30316
CULBREATH CHANDRA	2055 BENCAL DR SE	ATLANTA GA 30316
CASH EL INVESTMENTS LLC	850 OLD ALPHARETTA RD	ALPHARETTA GA 30005
ODWYER PROPERTIES LLC	850 OLD ALPHARETTA RD	ALPHARETTA GA 30005
ODWYER PROPERTIES LLC	850 OLD ALPHARETTA RD	ALPHARETTA GA 30005
ODWYER PROPERTIES LLC	850 OLD ALPHARETTA RD	ALPHARETTA GA 30005
CHRIS 180 SUPPORT ORGANIZATION INC	1017 FAYETTEVILLE RD STE B	ATLANTA GA 30316
BANKS PAUL W	3883 CHERU DR	DECATUR GA 30034
OM SAI ENTERPRISE INC	2000 FLAT SHOALS RD SE	ATLANTA GA 30316
OM SAI ENTERPRISES INC	2000 FLAT SHOALS RD SE	ATLANTA GA 30316
DICKENSON COPELAND CARMEN M	996 FAYETTEVILLE RD SE	ATLANTA GA 30316
CHRIS 180 SUPPORT ORGANIZATION INC	1017 FAYETTEVILLE RD STE B	ATLANTA GA 30316
DEKALB COUNTY	1300 COMMERCE DR	DECATUR GA 30030
FAYETTEVILLE ROAD CHURCH OF	1003 FAYETTEVILLE RD SE	ATLANTA GA 30316
GRAY HALLIE A JR	2079 BENCAL DR SE	ATLANTA GA 30316
CHRIS 180 SUPPORT ORGANIZATION INC	1017 FAYETTEVILLE RD STE B	ATLANTA GA 30316
PARKS TARYLN T	2174 LEFFERTS PL	ATLANTA GA 30316
BILES ROBBIE HOOD ESTATE PERS REP	1950 FLAT SHOALS RD	ATLANTA GA 30316
ZONGOR MICHAEL E	2244 WINDER CIR	FRANKLIN TN 37064
HOLLOWAY ARTHUR W	196 SOUTH AVE SE	ATLANTA GA 30315
EMERSON JOY C	2087 BENCAL DR SE	ATLANTA GA 30316
GRAY HALLIE ARNETT JR	2079 BENCAL DR SE	ATLANTA GA 30316
PUGH ANDREA	2041 BENCAL DR	ATLANTA GA 30316
WEST CHIQUETTA	2176 LEFFERTS PL	ATLANTA GA 30316
CASH SHELBY	2323 PIEDMONT RD NE UNIT 4309	ATLANTA GA 30324
O DWYER PROPERTIES LLC	850 OLD ALPHARETTA RD	ALPHARETTA GA 30005
ODWYER PROPERTIES LLC	850 OLD ALPHARETTA RD	ALPHARETTA GA 30005
BEASLEY FAMILY TOWERS INC	3033 RIVIERA DR # 200	NAPLES FL 34103
FB FLAT SHOALS ROAD LLC	4145 POWELL RD	POWELL OH 43065
SHREEHARI98 LLC	1046 FAYETTville RD SE	ATLANTA GA 30316
TERSULBRAN INC	400 MARKET PL	ROSWELL GA 30075
GOODWIN TEASHIA ADKINS	3556 TAMASSEE LN	BIRMINGHAM AL 35226
MENDHEIM SYNETRA	2048 FLAT SHOALS RD SE	ATLANTA GA 30316
OM SAI ENTERPRISES INC	2000 FLAT SHOALS RD SE	ATLANTA GA 30316
SMITH ASHLEY LYNN	691 14TH ST NW UNIT 103	ATLANTA GA 30318
O DWYER PROPERTIES LLC	850 OLD ALPHARETTA RD	ALPHARETTA GA 30005
JOHNSON QUENTIN	2170 LEFFERTS PL	ATLANTA GA 30316
OMKAR SINGH ENTERPRISES INC	1981 FLAT SHOALS RD SE	ATLANTA GA 30316
DAVIS LAWRENCE	961 FAYETTEVILLE RD SE	ATLANTA GA 30316
DALE RICHARD	2088 BENCAL DR SE	ATLANTA GA 30316
DEKALB COUNTY	1300 COMMERCE DR	DECATUR GA 30030

MARSHALL RICHARD LOUIS	2063 BENCAL DR SE	ATLANTA GA 30316
ROHDE TYMON P	2045 BENCAL DR	ATLANTA GA 30316
SMITH BRUCE MOORE JR	2178 LEFFERTS PL	ATLANTA GA 30307
JOHNSON DARRON	900 N STAFFORD ST CONDO 1502	ARLINGTON VA 22203
ODWYER PROPERTIES LLC	850 OLD ALPHARETTA RD	ALPHARETTA GA 30005
ODWYER PROPERTIES LLC	850 OLD ALPHARETTA RD	ALPHARETTA GA 30005
AIJ FLAT SHOALS LLC	5887 GLENRIDGE DR STE 440	ATLANTA GA 30328
CHRIS PROPERTIES LLC	1017 FAYETTEVILLE RD SE # B	ATLANTA GA 30316
OM SAI ENTERPRISE INC	2000 FLAT SHOALS RD SE	ATLANTA GA 30316
CHRIS PROPERTIES LLC	1017 FAYETTEVILLE RD	ATLANTA GA 30316
DEY SUBAN	2038 BENCAL DR SE	ATLANTA GA 30316
DEKALB COUNTY	1300 COMMERCE DR	DECATUR GA 30030
CHRIS 180 SUPPORT ORGANIZATION INC	1017 FAYETTEVILLE RD STE B	ATLANTA GA 30316
TRUST OF GREATER PINEY GROVE	1879 GLENWOOD AVE SE	ATLANTA GA 30316
BONILLA JOSE RAUL	987 FAYETTEVILLE RD SE	ATLANTA GA 30316
FAYETTEVILLE RD CHURCH OF GOD	1003 FAYETTEVILLE RD SE	ATLANTA GA 30316

Toll Brothers, Inc.

1065 Fayetteville Road Rezoning

August 30, 2022 @ 7:00 p.m.

COMMUNITY MEETING

NAME	ADDRESS	E-MAIL/PHONE NUMBER
Chiquette West	Collectors @ East Lake	Chiquettawest@gmail.com 4-580 5592
Veronica Marshall Richard Marshall	2063 Bencal Dr	404.668.3390 vm11672@aol.com
Yvonne Hicks	986 FAYETTEVILLE RD 30316	yvonnehicks@hotmail.com
Sharon Groves	1787 Terry Mill Rd SE	sdgroves@bellsouth.net
Catherine Freeman	2023 Bencal Dr SE Ft. Ga. 30316	Chatty Cat 2023@gmail.com 404/373-5413
Reginal Freeman	2023 Bencal Drive	RCFree44@gmail.com
D. Copeland	996 Fayetteville	d3copeland@gmail.com 404 988-3022

Toll Brothers, Inc.
1065 Fayetteville Road Rezoning
August 30, 2022 @ 7:00 p.m.
COMMUNITY MEETING

NAME	ADDRESS	E-MAIL/PHONE NUMBER
Lala Wingo	1779 Fayette Court	404 378-9484
Audrey Guthrie Nikita Cobb Barrett	2071 Bencal Dr Atl Ga 30316	MISS FAITH AUDREY @ aol.com gmail.com Nikita Cobb 1 @ gmh.edu 770-335-4820
Anita Deala-Gray	2079 Bencal DR SE Atlanta, GA 30316	heartasew44@yahoo.com
Hallie Gray, Jr.	2079 Bencal DR. SE Atlanta, GA 30316	404-424-6724 arnett_gray@bellsouth.net
Culbreath, Chandra	2055 Bencal Dr Atlanta Ga. 30316	Chandra2055@comcast.net
Renee Presley	2173 Lefterts Rd	Renpresley@gmail.com
Russell Elsh	850 Fayetteville Rd	russstheruler2@aol.com

Toll Brothers, Inc.

1065 Fayetteville Road Rezoning

August 30, 2022 @ 7:00 p.m.

COMMUNITY MEETING

NAME	ADDRESS	E-MAIL/PHONE NUMBER
Cynthia Kelley-Maddox	1960 BENCAL DRIVE S.E. ATL GA 30316-	Cynthiamaddox21@yahoo.com (404) 645-1735

Letter of Intent

FIRST AMENDED
STATEMENT OF INTENT/
WRITTEN JUSTIFICATION

and

Other Material Required by
DeKalb County Zoning Ordinance for the
Rezoning Application

of

TOLL BROTHERS, INC.

for

± 17.2 Acres of Land
located in Land Lots 147 and 148, 15th District

O-I to RSM (Conditional)

Submitted for the Applicant by:

Kathryn M. Zickert
Dennis J. Webb, Jr.
J. Alexander Brock
Smith, Gambrell & Russell, LLP
1105 W. Peachtree Street, NE
Atlanta, GA 30309
404-815-3500

I. INTRODUCTION

This Application seeks to rezone ± 17.2 acres of land located in the northwest quadrant of the intersection of Fayetteville Road and Graham Circle (“Subject Property”) from O-I (Office Institutional) to RSM (Residential Small Lot) for a townhome development. The Subject Property is more particularly located at 1065 Fayetteville Road, DeKalb County, Atlanta, Georgia (Parcel ID 1514707001). The property is currently improved with two radio broadcast towers¹ with the remaining area consisting primarily of forested areas and the floodplain of Sugar Creek which borders the property to the northeast. The Applicant intends to redevelop the Subject Property for a one hundred and two (102) single family attached condominium and associated amenities, including trails, a dog park, and pocket parks (“Proposed Development”). The Proposed Development is preserving a large portion of site area as enhanced open space, including natural woodland and vegetation adjacent to Sugar Creek. The enhanced open space will include $\pm 33,912$ square feet (“sf”) of pocket parks, a 10,166 sf dog park, $\pm 31,644$ sf of greenway with pedestrian trails, and $\pm 74,618$ sf of greenway within the floodplain, for a total of $\pm 150,340$ sf of enhanced open space ($\pm 20.1\%$ of the total site area). There will be no encroachment into the floodplain. The enhanced open space will allow a 50% density bonus or a total of 6 units per acre for the RSM district² (a density of ± 5.93 units per acre is proposed). The preserved open space will enhance the overall quality of the Proposed Development and be a valuable benefit to its residents.

The applicant and developer, Toll Brothers., Inc. (“Toll Bros.” or “Applicant”) is an award-winning FORTUNE 500 company founded in 1967, and is the nation's leading builder of luxury homes. Toll Bros. currently builds in 24 states nationwide and has built many

¹The radio towers are the former broadcast towers for the WWWE 1100 AM and WAEC 860 AM radio stations.

²Refer to DeKalb County Code of Ordinances §2.12.5, Tables 2.5 and 2.6.

communities in the metro Atlanta area. Its stated goal is to build to the highest standards that each market allows, which it seeks to apply to the Proposed Development. The Subject Property is in a fitting location for such high-quality development.

The Proposed Development and the requested RSM zoning are appropriate given what exists in the surrounding area today. To the north and east of the Subject Property are two undeveloped properties owned by the Greater Piney Woods Baptist Church and zoned R-75 (Residential Medium Lot-75). To the south, the Subject Property borders the right-of-way of Graham Circle. Across Graham Circle is the CHRIS 180 administrative offices and assisted living facility which is located within the City of Atlanta and zoned RG-3 (Residential General District) and C-1-C (Community Business District Conditional). To the west, the Subject Property abuts the right-of-way of U.S. Interstate 20 (“I-20”) and to the east the Subject Property fronts approximately 623 feet of Fayetteville Road.

The Subject Property is also ±435 feet north of the intersection of Fayetteville Road and Flat Shoals Road, which is a developed commercial node within the City of Atlanta. The commercial node is within walking distance of the Proposed Development, but is in need of revitalization. The node currently consists of several older gas stations and ±10,433 square foot shopping center containing a liquor store, cellular store, and nail salon among other tenants. Adjacent to the shopping center is a Family Dollar retail store located at 2021 Flat Shoals Road in Unincorporated DeKalb. One of the key components to commercial revitalization is the introduction of high-quality residences to support the local businesses, such as the Proposed Development.

In addition, the Proposed Development will act as a transition in use and intensity from the commercial node to the south and the existing single family residential to the north. The

primary goal of land use planning is to eliminate or minimize the potential adverse effect of the dissimilar uses of adjacent tracts of land by establishing a harmonious transition between them. The traditional method of achieving this goal is through both “off-site” and “on-site” transition. Off-site transition consists of avoiding the placement of dissimilar uses next to each other by placing uses of intermediate density between them. The proposed townhomes and RSM zoning will allow a transition in intensity and residential density between the commercial node at Fayetteville Road and Flat Shoals to the single family residential homes along Bencal Drive. The Proposed Development will also provide on-site transition, which might either supplement or replace off-site transition and consists of measures imposed on a particular property to protect neighborhoods from adverse effects. To achieve the onsite transition, the proposed site design will preserve approximately 3.45 acres as open space ($\pm 20.1\%$ of the total site area) closest to the neighboring residential. The portion of the greenspace within the floodplain will be preserved in its current natural condition with a mix of forest and undergrowth with the addition of pedestrian trails, while other areas will be enhanced with landscaped pocket parks. Moreover, the Subject Property is separated from the closest single family lots along Bencal Drive by the Greater Piney Grove Baptist Church and the Mt Gerizim Church of God properties, which are mostly wooded and landscaped. To the east, the Proposed Development is separated from the Chris180 facility by the right-of-way of Gresham Circle. Furthermore, the Greater Piney Grove Baptist Church property is significantly impacted by stream buffers along Sugar Creek making any future development highly unlikely. As a result, there is over 100 feet of forested buffer between the Subject Property and the closest lot line of the adjacent residence on Bencal Drive. Consequently, there will be no negative impact from the Proposed Development on the existing residential.

In sum, the proposed RSM zoning will allow the development of attractive, modern, upscale housing that is appropriate and harmonious with the existing surrounding development. This document is submitted as a Statement of Intent with regard to this Application, a preservation of the Applicant's constitutional rights, a Written Justification for the Application as required by the DeKalb County Zoning Ordinance §27-7.3.5.

II. CONDITIONS OF ZONING

Since filing its application, Toll Bros. has made many substantive changes to its proposed plan. These changes have resulted from negotiations with the community, as well as, the offices of the Commissioners Terry and Larry Johnson. The following are the conditions Toll Bros. accepts should the tract be rezoned:

1. The development shall substantially comply with the Site Plan dated August 22, 2022 and printed on February 16, 2023 prepared by Kimley-Horn and Associates, and attached as Exhibit A.
2. The development shall contain no more than 102 condominium units.
3. Pocket parks, foundation plantings, transitional buffers and other open spaces shall incorporate productive urban landscaping consisting of fruit bearing trees, shrubs and other native plants that support pollinating insects, where proper light and soil conditions permit. The landscape plan shall be submitted to the DeKalb County arborist for approval.
4. Electric panels in each house shall be sized to accommodate a 40-amp double-pole breaker labelled “reserved for solar.” The developer will offer a solar package upgrade for each unit. Additionally, the developer shall provide a 240v. AC plug in each garage to accommodate electric vehicle charging. All units also shall be equipped with “smart” thermostats with internet-ready connection.
5. A mandatory Homeowners’ Association (“HOA”) shall be established and shall be responsible for maintenance of all common areas/facilities.
6. A minimum of 25% of units may be leased as rental units, in whole or in part, but rentals of less than six months shall be prohibited. This restriction shall be written into the covenants of the HOA described in condition 5.

7. Maximum allowable density shall not exceed 6 dwelling units per acre. In exchange for the bonus density, the developer shall provide open space (i.e., greens and edible landscaping) as shown on the site plan. The dwelling units are not required to be located on individual lots. But, to achieve the density bonus. Developer shall subdivide the Subject Property into at least two lots. Parts of the subject property may be subdivided and owned separately and/or conveyed as separate tracts and to separate owners with different ownership structures.
8. In the event of a subdivision, separate ownership of parts of the subject property and/or a conveyance of part of the subject property to different owners, all conditions and variances shall remain applicable to any portion of the subject property, regardless of what person or entity owns the property.
9. Separate ownership of parts of the subject property and/or conveyance of part of the subject property to different owners shall not create non-conforming uses and shall not require any changes to the Site Plan for the development nor any variances. The newly created property lines which arise from these conveyances are not required to observe setback, buffer or other zoning requirements, except as may be reflected on Site Plan.
10. Setbacks, buffers and other zoning requirements shall be measured from existing right-of-way, versus any future right-of-way that may be dedicated incidental to development, unless any future right-of-way modification results in a right-of-way width reduction.
11. The product to be developed on the site plan shall be consistent with the elevations attached as Exhibit B.

III. IMPACT ANALYSIS

A.

THE ZONING PROPOSAL IS IN CONFORMITY WITH THE POLICY AND INTENT OF THE COMPREHENSIVE PLAN

The DeKalb County 2035 Comprehensive Plan (“Comp Plan”) designates the Subject Property as being within the Suburban (“SUB”) character area. The SUB character area fully allows the proposed RSM zoning district and the townhome use. The intent of the SUB character area is to encourage new development at a density of up to 8 dwelling units per acre with increased connectivity and accessibility. *See DeKalb County 2035 Comprehensive Plan*, pg.

77. The Proposed Development will have a proposed density of ±5.93 units per acre and will

install a streetscape with sidewalk along Fayetteville Road and Graham Circle. The sidewalks will provide pedestrian connectivity between the proposed residences and the surrounding community. The Proposed Development also fosters a number of general policies for the SUB character area in the County's Comprehensive Plan:

- Residential Protection - Protect stable neighborhoods from in-compatible development that could alter established single-family residential development patterns and density.
- Traditional Neighborhood Principles - In appropriate locations encourage residential development to conform with traditional neighborhood development principles including a higher mix of uses, improved pedestrian vehicular activity and increased pedestrian access to retail and other activities.
- Walkability - Locate development and activities within easy walking distance of transportation facilities.
- Greenspace - Wherever possible, connect to a regional network of greenspace and trails, available to pedestrians.
- Connectivity - Promote strong connectivity and continuity between existing and new developments.
- Density - Promote moderate density, traditional neighborhood development style residential subdivisions, which may utilize alley ways and rear vehicular access. as well as automobile dependency.

It should also be noted that the Proposed Development aligns with the current draft of DeKalb County's 2050 Comprehensive Land Use Plan ("2050 Comp Plan").³ The 2050 Comp Plan was not adopted as of the filing of this application, however the Applicant feels that it is

important to note that the Proposed Development will align with the goals of the adopted plan. The 2050 Comp Plan designates the Subject Property as being within the Walkable Neighborhoods character area, which allows the townhome with a density of 8 to 12 units per acre. The Walkable Neighborhoods character area is described as being “developed with elements of both the Traditional Neighborhood and Suburban character areas. This area includes smaller lot sizes and more connectivity than Suburban areas.” The Proposed Development meets this intent through the smaller lot townhome residences that will have internal sidewalks throughout, which will connect to a proposed streetscape and nearby existing retail and commercial uses, thus promoting walkability.

B.

THE PROPOSED REZONING PERMITS A USE THAT IS
SUITABLE IN VIEW OF THE USE AND DEVELOPMENT OF ADJACENT AND
NEARBY PROPERTY

The Proposed Development is suitable given the surrounding existing development. The Subject Property is located between undeveloped land to the north, a commercial node to the south, and I-20 to the west. The overall area consists of a mix of older single family detached residential, multifamily residential, commercial, and limited newer townhome and small lot residential. The Proposed Development will add more upscale housing options within walking distance of nearby commercial and act as a transition between the existing commercial and residential uses.

³The latest draft of the 2050 Comp Plan was obtained from the DeKalb County Planning and Sustainability website at <https://www.dekalbcountyga.gov/planning-and-sustainability/2021-comprehensive-plan-5-year-update> (last visited on August 24, 2022).

C.

THE SUBJECT PROPERTY DOES NOT HAVE A
REASONABLE ECONOMIC USE AS PRESENTLY ZONED.

The current O-I zoning restricts the development of the Subject Property to office, institutional, multifamily residential, and limited other uses. Since the COVID pandemic, development of new office space has experienced a decline and developing the Subject Property for office use is not practical. Residential development, particularly townhomes, are in demand, however. The Subject Property's proximity to downtown Atlanta and Decatur makes it attractive for residents who want to live in proximity to their employment as well as being near the multitude of restaurants and shops that those urban areas have to offer. As the area continues to grow, there will be a continued demand for a greater mix of residential unit types, including townhome development, beyond the single-family residential and aging multifamily that currently dominates the area. The Proposed Development will meet the market demand, however the Subject Property must be rezoned to accommodate such a development. Absent a rezoning to a more appropriate district, the Subject Property is likely to remain undeveloped.

D.

THE PROPOSED REZONING WILL NOT ADVERSELY AFFECT THE EXISTING
USE OR USABILITY OF ADJACENT OR NEARBY PROPERTY

See Paragraph II.B above.

E.

THERE ARE OTHER EXISTING OR CHANGING CONDITIONS
AFFECTING THE USE AND DEVELOPMENT OF THE PROPERTY

The area in which the Subject Property is located has lagged change and growth compared to other areas of DeKalb County. Many of the surrounding homes and multifamily were developed over 40 years ago, with few exceptions of newer housing being introduced into

the area. The newer developments, including Brighton Village and the Collection at East Lake, are a mix of attached townhomes and smaller lot single family detached in RSM districts. The change in demand is due to the preferences for modern young professionals that want to live in proximity to urban centers (e.g. downtown Atlanta and Decatur), and do not want the maintenance issues associated with traditional single family detached and their larger yards. The Proposed Development seeks to fill this demand by introducing upscale townhome residences.

F.

THE ZONING PROPOSAL WILL NOT ADVERSELY AFFECT HISTORIC BUILDINGS, SITES, DISTRICTS OR ARCHAEOLOGICAL RESOURCES

The Applicant knows of no historic buildings, sites, districts, or archaeological resources either on the Subject Property or located in the immediate vicinity that would suffer adverse impacts from the zoning requested.

G.

THE REQUESTED REZONING WILL NOT RESULT IN A USE WHICH WILL OR COULD CAUSE EXCESSIVE OR BURDENSOME USE OF EXISTING STREETS, TRANSPORTATION FACILITIES, UTILITIES, OR SCHOOLS

The Proposed Development will not significantly impact existing transportation facilities. The Applicant used the Institute of Traffic Engineers (ITE) Trip Generation Manual (Ninth Edition) to calculate vehicle trips for Residential Condominium/Townhomes (ITE 230). According to ITE, the 102 townhome units are expected to generate approximately 592.62 trips during a weekday, ±44.88 trips during a weekday a.m. peak hour, and ±53.04 trips during a weekday p.m. peak hour. The proposed trips, however are not anticipated to negatively affect adjacent roadways. Proposed Development has direct access to Fayetteville Road, which is classified as a Collector per the DeKalb County Recommended Functional Classification Map. In addition, it is a short distance from I-20, which provides quick access to regional travel.

These types of roads are intended to carry a large volume of traffic and are anticipated to easily accommodate the small number of trips from the Proposed Development. Moreover, these trips will be mitigated by the close access to mass transit. The project is served by MARTA Bus Route 74, which has two bus stops within 450 feet of the Subject Property.

Any school children living in the development will attend header Ronald E. McNair Discovery Learning Academy (Elementary), Ronald E. McNair Middle School, and Ronald E. McNair High School. All three schools are under capacity according to DeKalb County Schools' current enrolment & capacity data on its website. *See DeKalb County School District Operations website* at <https://www.dekalbschoolsga.org/operations/planning/> (last visited August 30, 2022). Regardless, townhome development typically does not attract families with school-age children, particularly when compared to traditional single family detached subdivision. As a result, the proposed townhomes are not anticipated to have any negative impact on local schools.

As for utilities, the Subject Property has access to water and sewer.

H.

WHETHER THE ZONING PROPOSAL ADVERSELY IMPACTS THE ENVIRONMENT OR SURROUNDING NATURAL RESOURCES.

A portion of the Subject Property is within the 100-year floodplain as indicated on FEMA FIRM panel 13089C0127J, effective on 05/16/2013. The Proposed Development will be located entirely outside of the floodplain and there will be no impacts to the portion of the Subject Property within the floodplain. Additionally, the Applicant will be providing a storm water pond to effectively treat and detain storm water runoff from the Proposed Development. Finally, the survey for the property does not reveal the presence of steep slopes or other environmentally sensitive areas (outside of the floodplain) located on site. Nonetheless, the Applicant will employ appropriate best management practices for erosion and sediment control during

construction.

IV. NOTICE OF CONSTITUTIONAL CHALLENGE TO UNDERLYING ZONING AND PRESERVATION OF CONSTITUTIONAL RIGHTS

The Applicant respectfully submits that the existing zoning on the Subject Property is unconstitutional and that a refusal to approve the proposed rezoning, or any attempt to rezone the Subject Property to an intervening classification, would be unlawful, arbitrary, capricious, irrational and a manifest abuse of discretion, all in violation of the Fifth Amendment and Fourteenth Amendment of the Constitution of the United States, and Article I, Section I, Paragraph I and Article I, Section III, Paragraph I of the Constitution of the State of Georgia.

A refusal to approve the proposed rezoning, or any attempt to rezone the Subject Property to an intervening classification, would discriminate unfairly between the owner of the Subject Property and other property owners similarly situated, in violation of the Fifth Amendment and Fourteenth Amendment of the Constitution of the United States, and Article I, Section I, Paragraph II of the Constitution of the State of Georgia.

A refusal to approve the proposed rezoning, or any attempt to rezone the Subject Property to an intervening classification, would amount to a taking of property, in violation of the Fifth Amendment and Fourteenth Amendment of the Constitution of the United States, and Article I, Section I, Paragraph I and Article I, Section III, Paragraph I of the Constitution of the State of Georgia.

A refusal to approve the proposed rezoning, or any attempt to rezone the Subject Property to an intervening classification, would be unjustified from a fact-based standpoint and instead would result only from constituent opposition, which would be an unlawful delegation of

authority in violation of Article IX, Section II, Paragraph IV of the Constitution of the State of Georgia.

A refusal to approve the proposed rezoning, or any attempt to rezone the Subject Property to an intervening classification, would be invalid inasmuch as the Zoning Ordinance of DeKalb County is unlawful, null and void because its adoption and map adoption/maintenance did not and does not comply with the requirements of its predecessor ordinance and/or the Zoning Procedures Law, O.C.G.A. § 36-66-1, *et seq.*

DeKalb County's Zoning Ordinance lacks adequate standards for the Board of Commissioners to exercise its power to review this Application. Specifically, the "standards and factors" set out in Section 27-7.3.5 are not sufficient to contain the discretion of the Board of Commissioners and to provide the Courts with a reasonable basis for judicial review. Because the stated standards (individually and collectively) are too vague and uncertain to provide reasonable guidance, the Zoning Ordinance is unlawful and violates, among other things, the Fifth Amendment and Fourteenth Amendment of the Constitution of the United States and Article I, Section I, Paragraphs I and II of the Constitution of the State of Georgia.

Any limitation on the time for presentation of the issues before the Board of Commissioners, which has the power to zone and rezone property, is a violation of the guarantees of free speech under the First Amendment of the Constitution of the United States and Article I, Section I, Paragraph V of the Constitution of the State of Georgia. Further, said limitations are in violation of the right to petition and assemble, in violation of the First Amendment of the Constitution of the United States and Article I, Section I, Paragraph IX of the Constitution of Georgia, as well as the due process clauses of the United States and Georgia Constitutions.

The Applicant raises the defenses of lack of standing and failure to exhaust administrative remedies.

V. CONCLUSION

For the foregoing reasons, the Applicant respectfully requests that the Rezoning Application at issue be approved. The Applicant also invites and welcomes any comments from Staff or other officials of DeKalb County.

This 16th day of March, 2023.

Respectfully Submitted,

A handwritten signature in blue ink, appearing to read "J. Alexander Brock", is written over a horizontal line.

Kathryn M. Zickert
Dennis J. Webb, Jr.
J. Alexander Brock
Attorneys for Applicant

Smith, Gambrell & Russell, LLP
1105 W. Peachtree Street, N.E., Suite 1000
Atlanta, Georgia 30309
404-815-3500

Legal Description & Survey

LEGAL DESCRIPTION

ALL THAT CERTAIN PARCEL OF LAND LYING AND BEING IN LAND LOTS 147 & 148 OF THE 15TH LAND DISTRICT, DEKALB COUNTY, GEORGIA AND BEING DESCRIBED ON A RETRACEMENT SURVEY DATED AUGUST 30, 2022, PREPARED FOR TOLL BROTHERS, BY MAXWELL-REDDICK AND ASSOCIATES WHICH READS AS FOLLOWS:

BEGINNING AT A ONE HALF INCH REBAR FOUND (1/2" RBF) AT THE INTERSECTION OF THE NORTHWESTERN RIGHT-OF-WAY OF FAYETTEVILLE ROAD, SE (R/W VARIES) AND THE NORTHEASTERN RIGHT-OF-WAY OF GRAHAM CIRCLE (60' R/W); THENCE ALONG THE NORTHEASTERN RIGHT-OF-WAY OF GRAHAM CIRCLE NORTH 53°05'15" WEST A DISTANCE OF 526.08' TO A ONE HALF INCH REBAR FOUND (1/2" RBF), THENCE SOUTH 36°50'09" WEST A DISTANCE OF 60.13' TO A ONE HALF INCH REBAR FOUND (1/2" RBF); THENCE NORTH 53°07'55" WEST A DISTANCE OF 71.42' TO A ONE HALF INCH REBAR FOUND (1/2" RBF) ON THE EASTERN RIGHT-OF-WAY OF INTERSTATE NO. 20; THENCE ALONG THE EASTERN RIGHT-OF-WAY OF INTERSTATE NO. 20 THE FOLLOWING COURSES AND DISTANCES:

NORTH 03°07'13" WEST A DISTANCE OF 158.08' TO A RIGHT-OF-WAY MONUMENT FOUND (RWMF);
NORTH 08°56'31" EAST A DISTANCE OF 296.92' TO A POINT;
SOUTH 76°45'51" EAST A DISTANCE OF 17.05' TO A RIGHT-OF-WAY MONUMENT FOUND (RWMF);
NORTH 12°13'51" EAST A DISTANCE OF 102.23' TO A POINT;
NORTH 33°43'12" EAST A DISTANCE OF 109.15' TO A POINT;
NORTH 10°15'45" WEST A DISTANCE OF 104.28' TO A POINT;
NORTH 01°44'18" EAST A DISTANCE OF 81.42' TO A POINT;
NORTH 12°16'12" EAST A DISTANCE OF 250.78' TO A ONE HALF INCH REBAR FOUND (1/2" RBF) ON THE EASTERN RIGHT-OF-WAY OF INTERSTATE NO. 20;

THENCE LEAVING THE RIGHT-OF-WAY OF INTERSTATE NO. 20 NORTH 89°09'22" EAST A DISTANCE OF 433.41' TO A POINT IN THE CENTERLINE OF SUGAR CREEK; THENCE ALONG THE CENTERLINE OF SUGAR CREEK WHICH MEANDERS ALONG A TRAVERSE LINE OF SOUTH 03°49'50" EAST A DISTANCE OF 687.86' TO A POINT; THENCE ALONG THE CENTERLINE OF SUGAR CREEK WHICH MEANDERS ALONG A TRAVERSE LINE OF SOUTH 52°22'08" EAST A DISTANCE OF 252.91' TO A POINT ON THE NORTHWESTERN RIGHT-OF-WAY OF FAYETTEVILLE ROAD SE;

THENCE ALONG THE NORTHWESTERN RIGHT-OF-WAY OF FAYETTEVILLE ROAD SE THE FOLLOWING COURSES AND DISTANCES:

SOUTH 41°15'07" EAST A DISTANCE OF 71.09' TO A RIGHT-OF-WAY MONUMENT FOUND (RWMF);
SOUTH 48°29'36" EAST A DISTANCE OF 29.61' TO A BENT REBAR FOUND (BRBF);
SOUTH 35°23'23" WEST COUNTERCLOCKWISE ALONG THE ARC OF A CURVE (ARC = 278.44', RADIUS = 1687.36') WHICH SUBTENDS A CHORD OF 278.13' TO A RIGHT-OF-WAY MONUMENT FOUND (RWMF);
SOUTH 31°14'26" WEST A DISTANCE OF 67.69' TO A POINT;

SOUTH 59°13'58" EAST A DISTANCE OF 15.00' TO A POINT;

SOUTH 36°26'12" WEST CLOCKWISE ALONG THE ARC OF A CURVE (ARC=221.63', RADIUS = 1028.36') WHICH SUBTENDS A CHORD OF 221.21' TO A ONE HALF INCH REBAR FOUND (1/2" RBF) WHICH IS THE POINT OF BEGINNING.

SAID PARCEL BOUND AS FOLLOWS:

NORTH BY LANDS OF THE TRUST OF GREATER PINEY GROVE BAPTIST CHURCH.

EAST BY LANDS OF THE TRUST OF GREATER PINEY GROVE BAPTIST CHURCH.

SOUTHEAST BY THE NORTHWESTERN RIGHT-OF-WAY OF FAYETTEVILLE ROAD, SE.

NORTHWEST BY THE NORTHEAST RIGHT-OF- WAY OF GRAHAM CIRCLE.

WEST BY THE EASTERN RIGHT-OF-WAY OF INTERSTATE NO. 20.

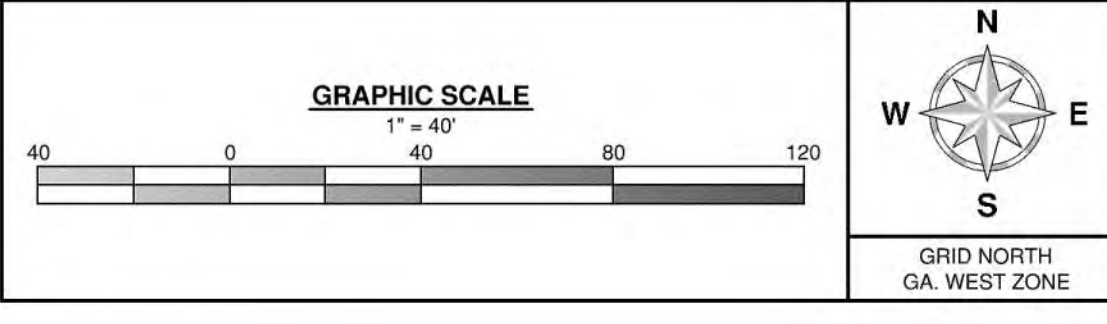

GENERAL SITE NOTES

- HORIZONTAL DATUM IS BASED ON NAD 1983 GA. WEST ZONE ESTABLISHED BY USING TRIMBLE VRS NOW NETWORK GPS.
- OWNERS AND TAX ID NUMBERS WERE TAKEN FROM THE DEKALB COUNTY TAX ASSESSORS WEB SITE.
- LAND SURVEYORS, AS LICENSED PROFESSIONALS BY THE STATE OF GEORGIA, ARE NOT EXPERTS IN THE IDENTIFICATION OF WETLANDS, CELESTIAL OR BURIAL GROUNDS, ITEMS OF HISTORICAL OR CULTURAL SIGNIFICANCE. THEREFORE, EXCEPTION IS TAKEN TO ANY SUCH MATTERS WHICH MAY EXIST WITHIN THE LIMITS OF THIS SURVEY.
- PROPERTIES WITHIN THE LIMITS OF THIS SURVEY MAY BE SUBJECT TO EASEMENTS, RESERVATIONS, RIGHTS OF WAY, OR RESTRICTIONS WHICH ARE NOT RECORDED OR ARE OTHERWISE UNKNOWN TO THE SURVEYOR. THEREFORE, EXCEPTION IS TAKEN TO ANY SUCH ITEMS.

FLOOD ZONE NOTE

BY GRAPHICAL PLOTTING ACCORDING TO F.I.R.M. MAP NO. 1000001011, WITH AN EFFECTIVE REVISION DATE OF 5/16/2013, A PORTION OF THIS PROPERTY LIES WITHIN ZONE 'X'. ZONE 'X' IS NOT A SPECIAL FLOOD HAZARD ZONE INUNDATED BY THE 100-YR FLOOD. ANOTHER PORTION OF THIS PROPERTY LIES WITHIN ZONE 'AE'. ZONE 'AE' IS A SPECIAL FLOOD HAZARD ZONE INUNDATED BY THE 100-YR FLOOD.

RIPARIAN RIGHTS NOTE

THE BOUNDARY IS SUBJECT TO CHANGE DUE TO NATURAL CAUSES AND THAT IT MAY OR MAY NOT REPRESENT THE ACTUAL LOCATION OF THE LIMIT OF TITLE.

- CORNER LEGEND**
- RBF - REBAR FOUND
 - BRBF - BENT REBAR FOUND
 - RF - IRON PIPE FOUND
 - BF - BENT IRON PIPE FOUND
 - CF - CAPPED REBAR SET
 - CTF - CAPPED TOP PIPE FOUND
 - RW - RIGHT-OF-WAY MARKER FOUND
 - NF - NAIL FOUND
- LEGEND**
- WOODS DMP LINE
 - STORM PIPE
 - SANITARY SEWER
 - WATER
 - FIBER OPTIC
 - UNDERGROUND POWER
 - ELECTRIC METER
 - ELECTRIC TRANSFORMER
 - WATER VALVE
 - WATER METER
 - PIPE HORSEWAT
 - WATER SPOUT
 - FIBER OPTIC BOX
 - FIBER OPTIC PEDESTAL

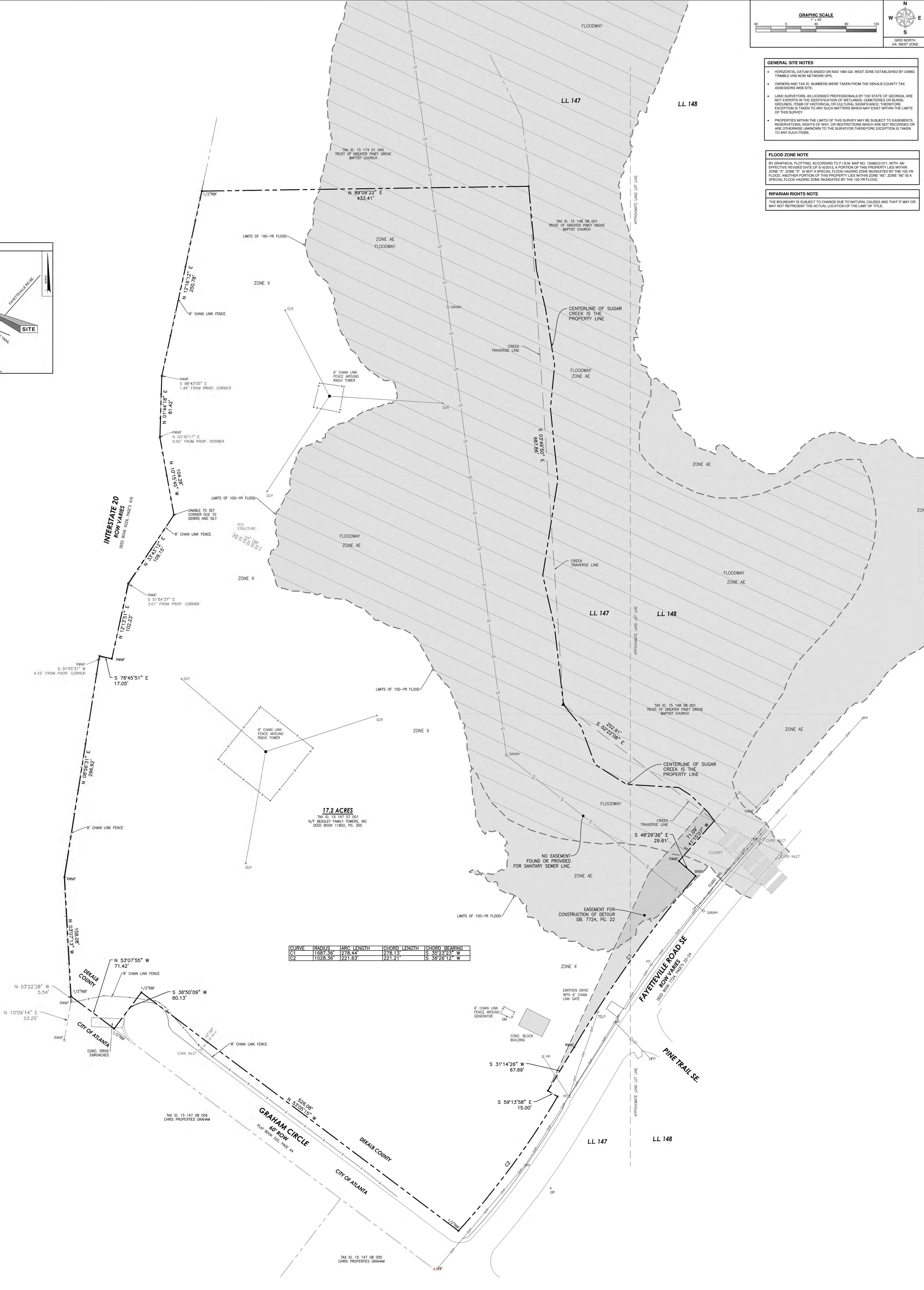
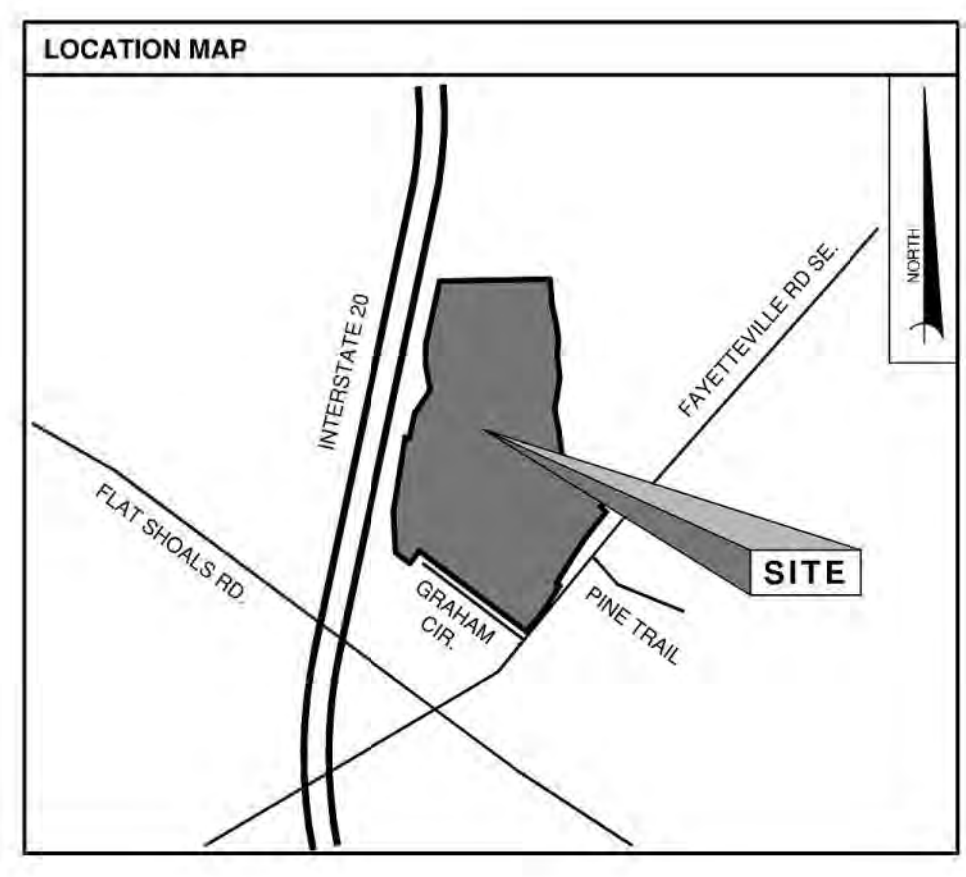

17.2 ACRES
 TAX ID. 15 147 07 001
 N/T BEKLEY FAMILY TRUSTS, INC
 DEED BOOK 11802, PG. 300

CURVE	RADIUS	ARC LENGTH	CHORD LENGTH	CHORD BEARING
C1	1169.36	278.44	278.13	S 35°23'23" W
C2	11023.36	1221.53	1221.21	S 35°29'12" W

SURVEYOR CERTIFICATION

THIS PLAT IS A RETRACEMENT OF AN EXISTING PARCEL OR PARCELS OF LAND AND DOES NOT SUBDIVIDE OR CREATE A NEW PARCEL, OR MAKE ANY CHANGES TO ANY REAL PROPERTY BOUNDARIES. THE RECORDING INFORMATION OF THE DOCUMENTS, MAPS, PLATS, OR OTHER INSTRUMENTS WHICH CREATED THE PARCELS OR PARCELS ARE STATED HEREON. RECORDATION OF THIS PLAT DOES NOT IMPLY APPROVAL OF ANY LOCAL JURISDICTION, AVAILABILITY OF PERMITS, COMPLIANCE WITH LOCAL REGULATIONS OR REQUIREMENTS, OR SUITABILITY FOR ANY USE OR PURPOSE OF THE LAND. FURTHERMORE, THE UNDERSIGNED LAND SURVEYOR CERTIFIES THAT THIS PLAT COMPLIES WITH THE MINIMUM TECHNICAL STANDARDS FOR PROPERTY SURVEYS IN GEORGIA AS SET FORTH IN THE RULES AND REGULATIONS OF THE GEORGIA BOARD OF REGISTRATION FOR PROFESSIONAL ENGINEERS AND LAND SURVEYORS AND AS SET FORTH IN O.C.G.A.

Preliminary

08/31/2022 7:41:16 AM

PRECISION DATA

E.D.C. FIELD ERROR PER ANGLE	1" / 60,806'	FIELD EQUIPMENT	TRIMBLE R12 GPS
E.D.C. PLAT	0.00' / 0.1'	MARKING LOCATOR	TRIMBLE ACCESS
		NETWORK LEAST SQUARES	TRIMBLE SSRS-PILOT

DRAWN BY: DY
FIELD WORK: TR, N, M, G
DATE: 08-30-2022
JOB NO.: 2022-246
SCALE: 1" = 40'

RETRACEMENT SURVEY OF 17.2 ACRES PREPARED FOR TOLL BROTHERS LOCATED IN LAND LOTS 147 AND 148 OF THE 15TH LAND DISTRICT, DEKALB COUNTY GA

Site Plan

Elevations





K:\AMT_Marketing\Thrive Homes\Sugar Creek\CAD\Open Space Exhibit.dwg Layout1 Aug 30, 2022 5:29pm by: Almarie Brennan

NOTES:	
SITE AREA:	17.13 AC (746,183 SF)
PROPOSED ZONING:	RSM
CHARACTER AREA:	SUB
MINIMUM OPEN SPACE PER RSM:	20% OF TOTAL SITE AREA
DENSITY BONUS CALCULATIONS	
BASE MAX (RSM, SUB)	4 DU/ACRE
TARGET DENSITY BONUS	6 DU/ACRE
ENHANCED OPEN SPACE REQUIREMENT: 20% OF TOTAL SITE = 149,237 SF	
* POCKET PARK (MIN. 2,000 SF) 12,280 SF	
* GREENWAY W/ PEDESTRIAN TRAILS (MIN. 50-FT WIDTH) 66,200 SF	
* GREENWAY W/IN FLOODPLAIN 74,200 SF	
(MAX. 50% OF TOTAL OPEN SPACE REQUIREMENT)	
TOTAL ENHANCED OPEN SPACE PROVIDED = 152,680 SF	
PROPOSED 26'X50' TOWNHOMES	102 UNITS (5.95 UNITS/ACRE - COMPLIES)

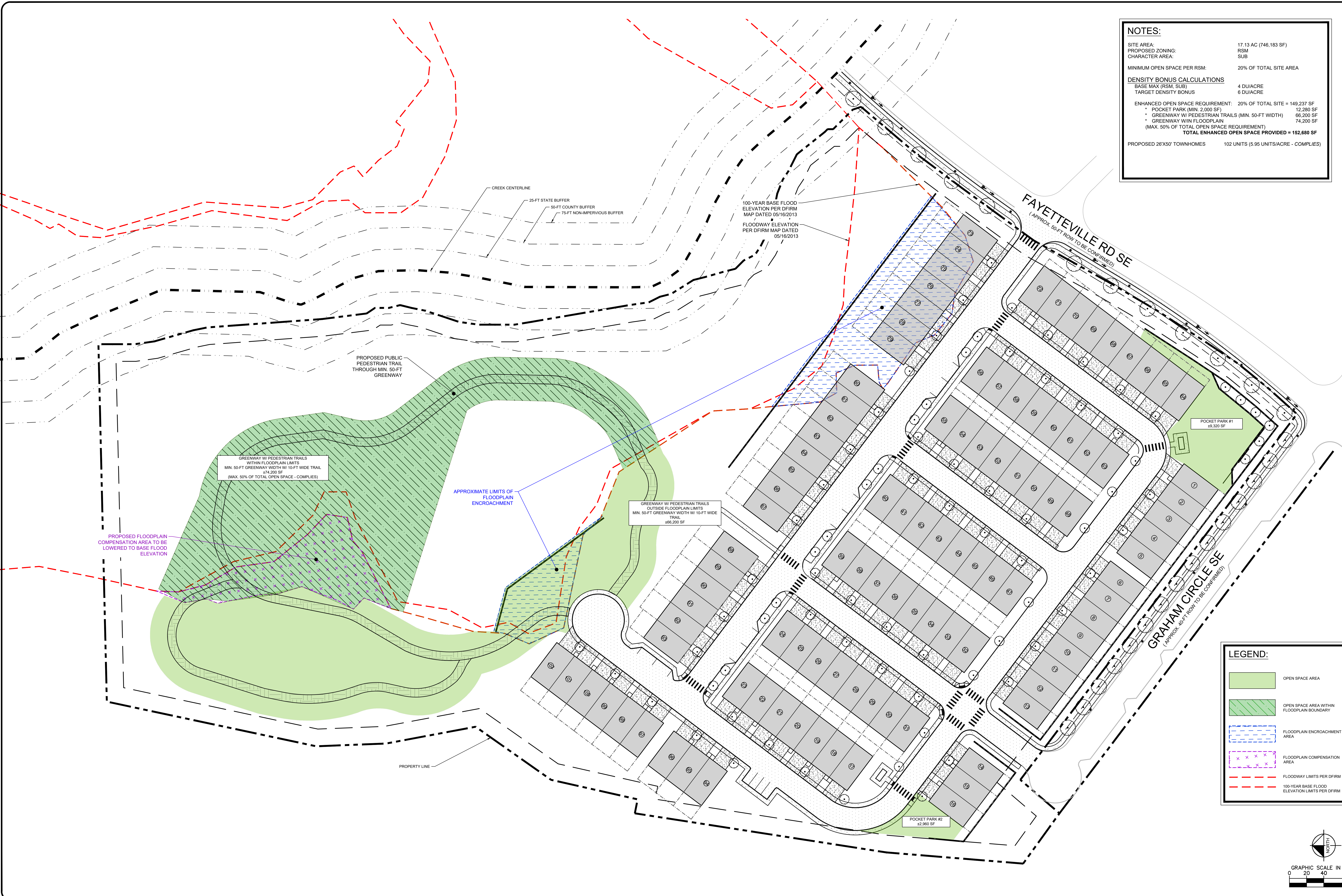

LEGEND:	
	OPEN SPACE AREA
	OPEN SPACE AREA WITHIN FLOODPLAIN BOUNDARY
	FLOODPLAIN ENCROACHMENT AREA
	FLOODPLAIN COMPENSATION AREA
	FLOODWAY LIMITS PER DFIRM
	100-YEAR BASE FLOOD ELEVATION LIMITS PER DFIRM

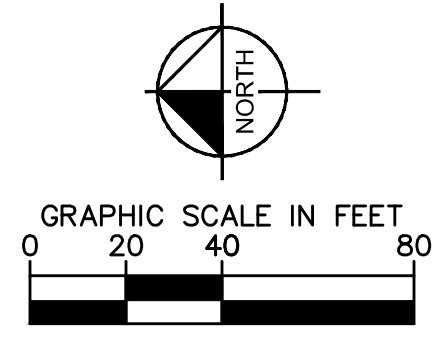

Kimley»Horn
 817 W. PEACHTREE STREET, NW, SUITE 601, ATLANTA, GEORGIA 30308
 PHONE: (404) 419-8700 | www.kimley-horn.com

TITLE:
DENSITY BONUS & OPEN SPACE EXHIBIT

PROJECT:
TOLL SUGAR CREEK

CLIENT:
TOLL SOUTHEAST LP COMPANY INC.

JOB NUMBER: 012826XX
 SCALE: 1" = 40'
 DATE: 8/30/2022
 SHEET: **EXHIBIT A**

THIS DOCUMENT, TOGETHER WITH THE CONCEPTS AND DESIGNS PRESENTED HEREIN, AS AN INSTRUMENT OF SERVICE, IS INTENDED ONLY FOR THE SPECIFIC PURPOSE AND CLIENT FOR WHICH IT WAS PREPARED. REUSE OF AND IMPROPER RELIANCE ON THIS DOCUMENT WITHOUT WRITTEN AUTHORIZATION AND ADAPTATION BY KIMLEY+HORN AND ASSOCIATES, INC. SHALL BE WITHOUT LIABILITY TO KIMLEY+HORN AND ASSOCIATES, INC. COPYRIGHT KIMLEY+HORN AND ASSOCIATES, INC. 2017

NOTE:
 THIS EXHIBIT HAS BEEN PREPARED USING AERIAL IMAGERY, WITHOUT THE ASSISTANCE OF A TREE SURVEYOR OR LICENSED ARBORIST, AND IS TO BE USED FOR PRELIMINARY COORDINATION PURPOSES ONLY.

A COMPREHENSIVE TREE SURVEY, ARBORIST ASSESSMENT, AND REVIEW BY A LANDSCAPE ARCHITECT SHALL BE COMPLETED FOR THE PROPERTY PRIOR TO ISSUANCE OF ANY PERMITS OR FINAL CONSTRUCTION PLANS.

DEKALB COUNTY TREE PROTECTION AND REPLACEMENT REQUIREMENT NOTES (PER COUNTY CODE SEC. 14-39):

- EITHER ONE HUNDRED TWENTY (120) INCHES (DBH) PER ACRE OR TWENTY-FIVE (25) PERCENT OF EXISTING SIGNIFICANT TREES PER ACRE OF SUCH SIGNIFICANT TREES, WHICHEVER IS LESS, SHALL BE PRESERVED ON THE SITE. EXCEPT FOR ZONED C-1, C-2, M, OR M-2 SITES, TREES AND TREE SAVE AREAS COUNTING TOWARD THIS REQUIREMENT SHALL NOT BE LOCATED IN REQUIRED BUFFER ZONES. TREES AND TREE SAVE AREAS COUNTING TOWARD THIS REQUIREMENT ON SITES ZONED C-1, C-2, M OR M-2 MAY BE LOCATED IN STREAM BUFFERS AND STATE BUFFER ZONES, TRANSITIONAL BUFFER ZONES AND DESIGNATED FLOODPLAINS.
 - IF THE COUNTY ARBORIST DETERMINES THAT SPECIAL CONSTRAINTS OF A SITE RESULT IN AN INABILITY TO BUILD OR DEVELOP WITHOUT REMOVING SIGNIFICANT TREES ON A SITE, WHERE THERE ARE ONLY ONE HUNDRED TWENTY (120) INCHES (DBH) PER ACRE OR LESS OF EXISTING SIGNIFICANT TREES, THE ARBORIST MAY PERMIT THE REMOVAL OF ONE OR MORE SIGNIFICANT TREES. TREES REMOVED PURSUANT TO THIS SECTION MUST BE REPLACED WITH TREES ONE (1) TIMES THE DIAMETER INCHES OF THOSE REMOVED.
- THE APPLICANT SHALL LANDSCAPE THE AREAS WITH TREES AND OTHER PLANT MATERIALS IN ACCORDANCE WITH THE FOLLOWING STANDARDS:
 - RESIDENTIAL DEVELOPMENTS: ALL RESIDENTIAL SUBDIVISIONS SHALL HAVE AN AVERAGE DENSITY OF FIFTEEN (15) DENSITY UNITS PER ACRE. REQUIRED TREES MAY BE LOCATED ON INDIVIDUAL LOTS OR IN SUBDIVISIONS IN WHICH THERE IS COMMONLY OWNED PROPERTY MAY BE LOCATED ON SUCH COMMONLY OWNED PROPERTY.
 - NON-RESIDENTIAL AND MULTIFAMILY DEVELOPMENTS: THE QUANTITY OF TOTAL EXISTING/REPLACEMENT TREES ON SITE MUST BE SUFFICIENT SO AS TO PRODUCE A TOTAL SITE DENSITY FACTOR OF NO LESS THAN THIRTY (30) DENSITY UNITS PER ACRE.
- WITH THE EXCEPTION OF C-1, C-2, M, OR M-2 ZONED PROPERTY, THE TOTAL TREE DENSITY UNITS REQUIRED FOR A PARCEL OR LOT SHALL BE COMPUTED BASED ON THE AREA OF THE PARCEL OR LOT, EXCLUDING ALL AREA WITHIN THE 100-YEAR FLOODPLAIN. TOTAL TREE DENSITY UNITS REQUIRED FOR C-1, C-2, M, OR M-2 ZONED PROPERTY SHALL BE COMPUTED BASED ON THE AREA OF THE PARCEL OR LOT, INCLUDING ALL AREA WITHIN THE ONE HUNDRED-YEAR FLOODPLAIN.

LEGEND:

- DISTURBED AREA FOR PROPOSED DEVELOPMENT
- MINOR DISTURBANCE FOR TRAIL PLACEMENT ONLY
- EXISTING TREE LINE
- PROPERTY LINE
- FLOODWAY LIMITS PER DFIRM
- 100-YEAR BASE FLOOD ELEVATION LIMITS PER DFIRM

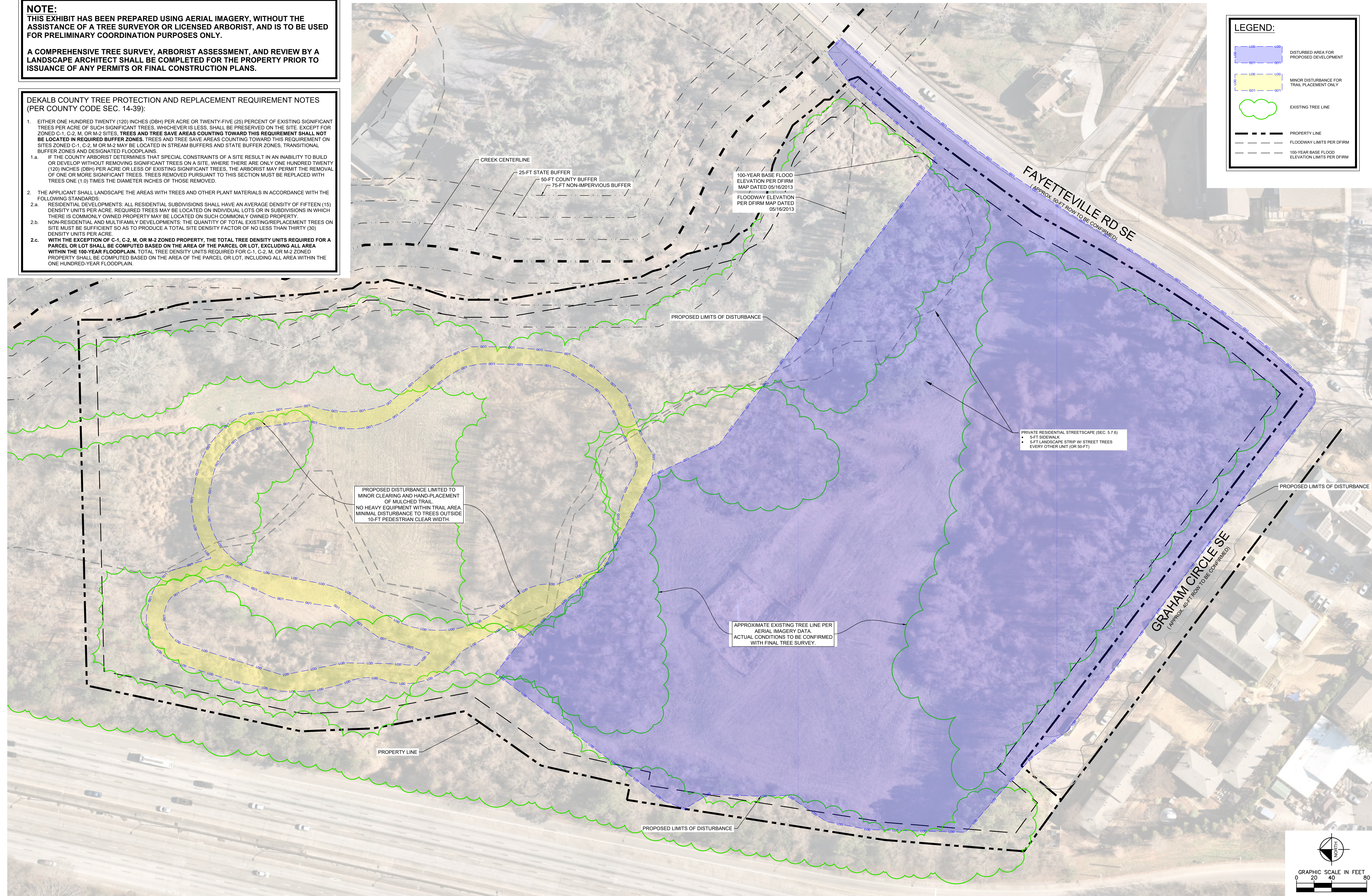

K:\AMT_Marketing\Thrive Homes\Sugar Creek\CAD\Landscape Exhibit.dwg EXISTING Aug 31, 2022 5:13pm by: Almarie Brennan

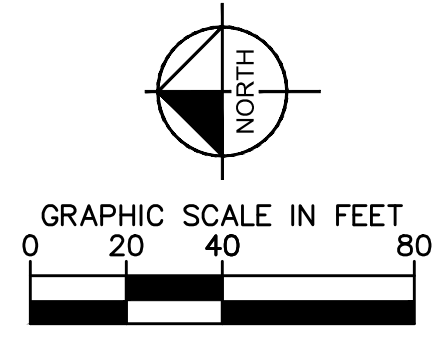

Kimley»Horn

817 W. PEACHTREE STREET, NW, SUITE 601, ATLANTA, GEORGIA 30308
 PHONE: (404) 419-8700 | www.kimley-horn.com

TITLE:
PRELIMINARY TREE IMPACT EXHIBIT - EXISTING CONDITIONS

PROJECT:
TOLL SUGAR CREEK

CLIENT:
TOLL SOUTHEAST LP COMPANY INC.

JOB NUMBER: 012826XX
 SCALE: 1" = 40'
 DATE: 8/31/2022
 SHEET: **EXHIBIT B**

THIS DOCUMENT, TOGETHER WITH THE CONCEPTS AND DESIGNS PRESENTED HEREIN, AS AN INSTRUMENT OF SERVICE, IS INTENDED ONLY FOR THE SPECIFIC PURPOSE AND CLIENT FOR WHICH IT WAS PREPARED. REUSE OF AND IMPROPER RELIANCE ON THIS DOCUMENT WITHOUT WRITTEN AUTHORIZATION AND ADAPTATION BY KIMLEY-HORN AND ASSOCIATES, INC. SHALL BE WITHOUT LIABILITY TO KIMLEY-HORN AND ASSOCIATES, INC. COPYRIGHT KIMLEY-HORN AND ASSOCIATES, INC. 2017

NOTE:
 THIS EXHIBIT HAS BEEN PREPARED USING AERIAL IMAGERY, WITHOUT THE ASSISTANCE OF A TREE SURVEYOR OR LICENSED ARBORIST, AND IS TO BE USED FOR PRELIMINARY COORDINATION PURPOSES ONLY.

A COMPREHENSIVE TREE SURVEY, ARBORIST ASSESSMENT, AND REVIEW BY A LANDSCAPE ARCHITECT SHALL BE COMPLETED FOR THE PROPERTY PRIOR TO ISSUANCE OF ANY PERMITS OR FINAL CONSTRUCTION PLANS.

DEKALB COUNTY TREE PROTECTION AND REPLACEMENT REQUIREMENT NOTES (PER COUNTY CODE SEC. 14-39):

- EITHER ONE HUNDRED TWENTY (120) INCHES (DBH) PER ACRE OR TWENTY-FIVE (25) PERCENT OF EXISTING SIGNIFICANT TREES PER ACRE OF SUCH SIGNIFICANT TREES, WHICHEVER IS LESS, SHALL BE PRESERVED ON THE SITE. EXCEPT FOR ZONED C-1, C-2, M, OR M-2 SITES, TREES AND TREE SAVE AREAS COUNTING TOWARD THIS REQUIREMENT SHALL NOT BE LOCATED IN REQUIRED BUFFER ZONES. TREES AND TREE SAVE AREAS COUNTING TOWARD THIS REQUIREMENT ON SITES ZONED C-1, C-2, M OR M-2 MAY BE LOCATED IN STREAM BUFFERS AND STATE BUFFER ZONES, TRANSITIONAL BUFFER ZONES AND DESIGNATED FLOODPLAINS.
 - IF THE COUNTY ARBORIST DETERMINES THAT SPECIAL CONSTRAINTS OF A SITE RESULT IN AN INABILITY TO BUILD OR DEVELOP WITHOUT REMOVING SIGNIFICANT TREES ON A SITE, WHERE THERE ARE ONLY ONE HUNDRED TWENTY (120) INCHES (DBH) PER ACRE OR LESS OF EXISTING SIGNIFICANT TREES, THE ARBORIST MAY PERMIT THE REMOVAL OF ONE OR MORE SIGNIFICANT TREES. TREES REMOVED PURSUANT TO THIS SECTION MUST BE REPLACED WITH TREES ONE (1.0) TIMES THE DIAMETER INCHES OF THOSE REMOVED.
- THE APPLICANT SHALL LANDSCAPE THE AREAS WITH TREES AND OTHER PLANT MATERIALS IN ACCORDANCE WITH THE FOLLOWING STANDARDS:
 - RESIDENTIAL DEVELOPMENTS: ALL RESIDENTIAL SUBDIVISIONS SHALL HAVE AN AVERAGE DENSITY OF FIFTEEN (15) DENSITY UNITS PER ACRE. REQUIRED TREES MAY BE LOCATED ON INDIVIDUAL LOTS OR IN SUBDIVISIONS IN WHICH THERE IS COMMONLY OWNED PROPERTY MAY BE LOCATED ON SUCH COMMONLY OWNED PROPERTY.
 - NON-RESIDENTIAL AND MULTIFAMILY DEVELOPMENTS: THE QUANTITY OF TOTAL EXISTING/REPLACEMENT TREES ON SITE MUST BE SUFFICIENT SO AS TO PRODUCE A TOTAL SITE DENSITY FACTOR OF NO LESS THAN THIRTY (30) DENSITY UNITS PER ACRE.
- WITH THE EXCEPTION OF C-1, C-2, M, OR M-2 ZONED PROPERTY, THE TOTAL TREE DENSITY UNITS REQUIRED FOR A PARCEL OR LOT SHALL BE COMPUTED BASED ON THE AREA OF THE PARCEL OR LOT, EXCLUDING ALL AREA WITHIN THE 100-YEAR FLOODPLAIN. TOTAL TREE DENSITY UNITS REQUIRED FOR C-1, C-2, M, OR M-2 ZONED PROPERTY SHALL BE COMPUTED BASED ON THE AREA OF THE PARCEL OR LOT, INCLUDING ALL AREA WITHIN THE ONE HUNDRED-YEAR FLOODPLAIN.

LEGEND:

- DISTURBED AREA FOR PROPOSED DEVELOPMENT
- MINOR DISTURBANCE FOR TRAIL PLACEMENT ONLY
- EXISTING TREE LINE TO REMAIN
- EXISTING TREE LINE TO REMAIN
- PROPOSED ON-SITE TREE
- PROPERTY LINE
- FLOODWAY LIMITS PER DFIRM
- 100-YEAR BASE FLOOD ELEVATION LIMITS PER DFIRM

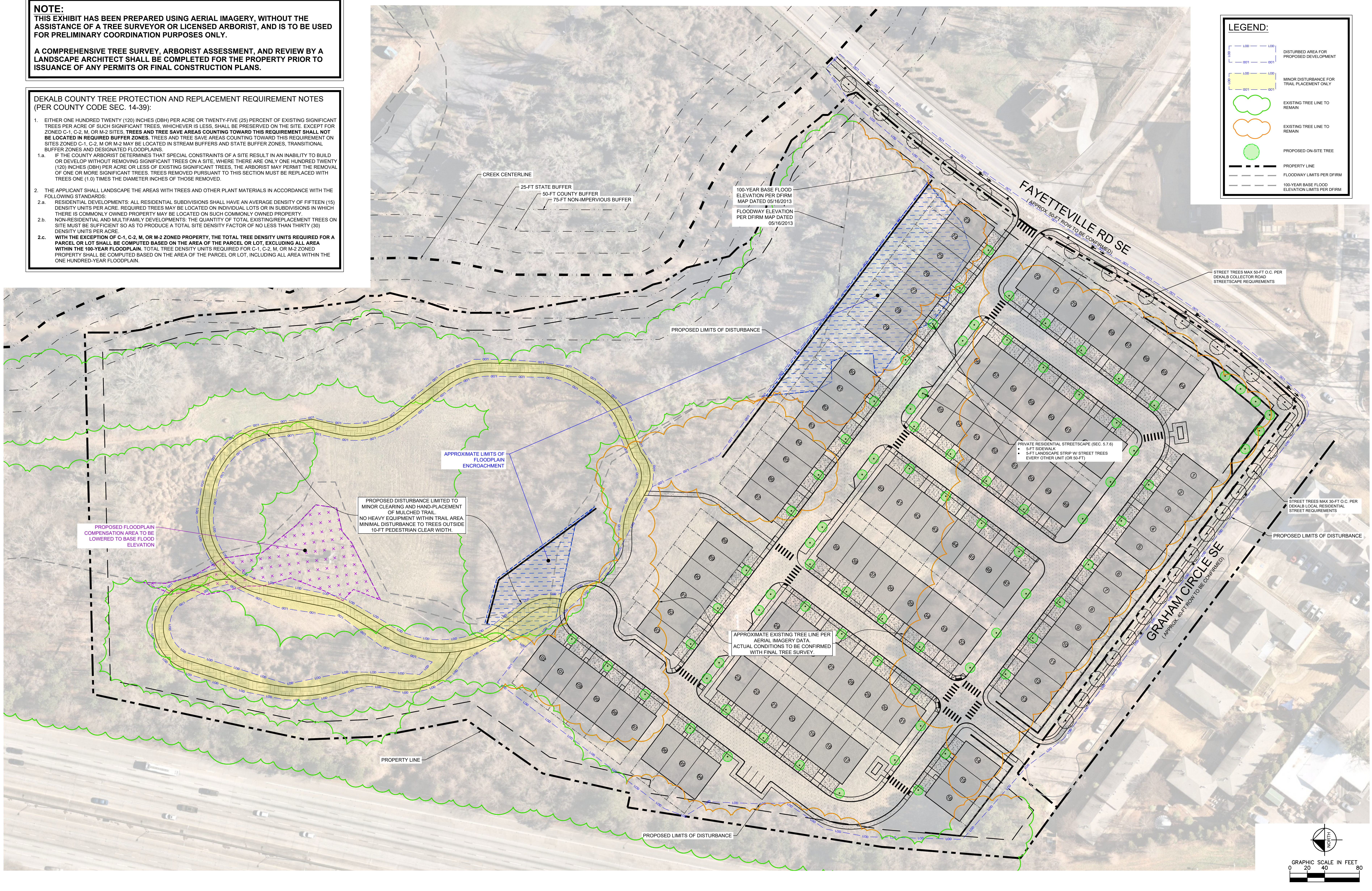

K:\AMT_Marketing\Thrive Homes\Sugar Creek\CAD\Landscapes Exhibit.dwg PROPOSED Aug 31, 2022 5:17pm by: Almarie Brennan

Kimley»Horn

817 W. PEACHTREE STREET, NW, SUITE 601, ATLANTA, GEORGIA 30308
 PHONE: (404) 419-8700 | www.kimley-horn.com

TITLE: **PRELIMINARY LANDSCAPE EXHIBIT - PROPOSED CONDITIONS**

PROJECT: **TOLL SUGAR CREEK**

CLIENT: **TOLL SOUTHEAST LP COMPANY INC.**

JOB NUMBER: 012826XX
 SCALE: 1" = 40'
 DATE: 8/31/2022
 SHEET: **EXHIBIT C**

THIS DOCUMENT, TOGETHER WITH THE CONCEPTS AND DESIGNS PRESENTED HEREIN, AS AN INSTRUMENT OF SERVICE, IS INTENDED ONLY FOR THE SPECIFIC PURPOSE AND CLIENT FOR WHICH IT WAS PREPARED. REUSE OF AND IMPROPER RELIANCE ON THIS DOCUMENT WITHOUT WRITTEN AUTHORIZATION AND ADAPTATION BY KIMLEY-HORN AND ASSOCIATES, INC. SHALL BE WITHOUT LIABILITY TO KIMLEY-HORN AND ASSOCIATES, INC. COPYRIGHT KIMLEY-HORN AND ASSOCIATES, INC. 2017

EMAIL OPPOSITION FOR N12-2022-2262 Z-22-1246092

From: Sharon Groves <sdgroves@bellsouth.net>

Sent: Tuesday, November 1, 2022 5:32 PM

To: Plansustain <plansustain@dekalbcountyga.gov>

Subject: Case N12-2022-2262 Z-22-1246092 15-147-07-001 1065 Fayetteville Rd, Atlanta, GA 30316

SUBJECT: Case N12-2022-2262 Z-22-1246092
15-147-07-001 - 1065 Fayetteville Rd, Atlanta, GA 30316

Dear Mr./Ms.:

The Terry Mill Community Association opposes the townhouse development at 1065 Fayetteville Rd, Atlanta, GA 30316.

We oppose the rezoning and the development of the proposed development for the following reasons:

1. The proposed entrance/exit from the townhomes onto Graham Circle (a dead end street) would create a hardship for staff and visitors of Chris Kids, including the meetings of the Terry Mill Community Association. The street is used for parking.
2. Traffic. Traffic is already very heavy on Fayetteville Road between Glenwood Avenue and Flat Shoals Road, especially during morning and evening hours. This is because people are commuting to and from work and school buses are carrying children to and from school. Often on Fayetteville Road traffic headed toward Flat Shoals Road is backed up past Bencal Drive. This also makes it difficult for residents on the side streets to exit onto Fayetteville Road. Cars exiting Graham Circle can have difficulty exiting onto Fayetteville Road during high traffic times, as well.
3. The development is too dense. The proposal is for 104 townhomes with two-car garages. That will probably add an additional 200 or more cars. A less dense development is suggested.

Sincerely,

Mrs. Iula Wright, President 404-378-9484 home
Terry Mill Community Association
1779 Fayetteville Ct. SE
Atlanta, GA 30316

Submitted by *Sharon Groves*
sdgroves@bellsouth.net
770-655-6505 cell



Changing Directions.
Changing Lives.

Board of Directors

Julia Houston (Chair)
Jay Bernath (Vice Chair)
Ana Amato (Treasurer)
Cyril Turner (Secretary)

Isys Caffey-Home
Emily Chambers
Lori Chennault
Kathy Colbenson
Lenore Cusick
Dan Diffley
Todd Ellis
April Estes
Deirdra Glover
Bo Keatley
Rob Kight
Michael Lammons
Paula Larson
Marybeth Leamer
Pascal R. Lewis
Maney Mazloom
Terrin McKay
Araya Mesfin
Condace Pressley
Sheila Ray
Terry Russell
Maria Smith
Steve Tedder
Rebecca Woods

November 1, 2022

Re: N12-2022-2262 Z-22-1246092
15-147-07-001
1065 Fayetteville Road
Atlanta, GA 30316

Dear Planning Commission,

I am sending this letter to oppose the application by Toll Brothers to re-zone the district to RSM for the construction of 104 single family attached townhomes as currently planned. With each townhome having two cars, an additional 208 cars will be entering and exiting the development each day. This poses a danger to the residents of Summit Trail Apartments who are pedestrians. Summit Trail Apartments is a permanent supportive housing program serving 18 - 24+ year old young adults who are aging out of foster care or who were formerly homeless.

Specifically, we oppose an entrance/exit to the townhome development using Graham Circle which is a short dead-end street. Graham Circle entrance/exit has limited sight distance on Fayetteville Road as cars come over the hill from Flat Shoals Road.

We propose that the one entrance/exit to the development be directly across from Pine Trail which provides excellent sight distance both ways on Fayetteville Road and protects our pedestrian at-risk population.

We have spoken to the applicant's attorney about options which include 1) a permanent restriction of any access to Graham Circle and 2) a reduction of the number of townhomes so that the project requires one entrance/exit only, instead of two.

Thank you for your attention to this really important matter.

Sincerely,

Kathy Colbenson, LMFT
President & CEO

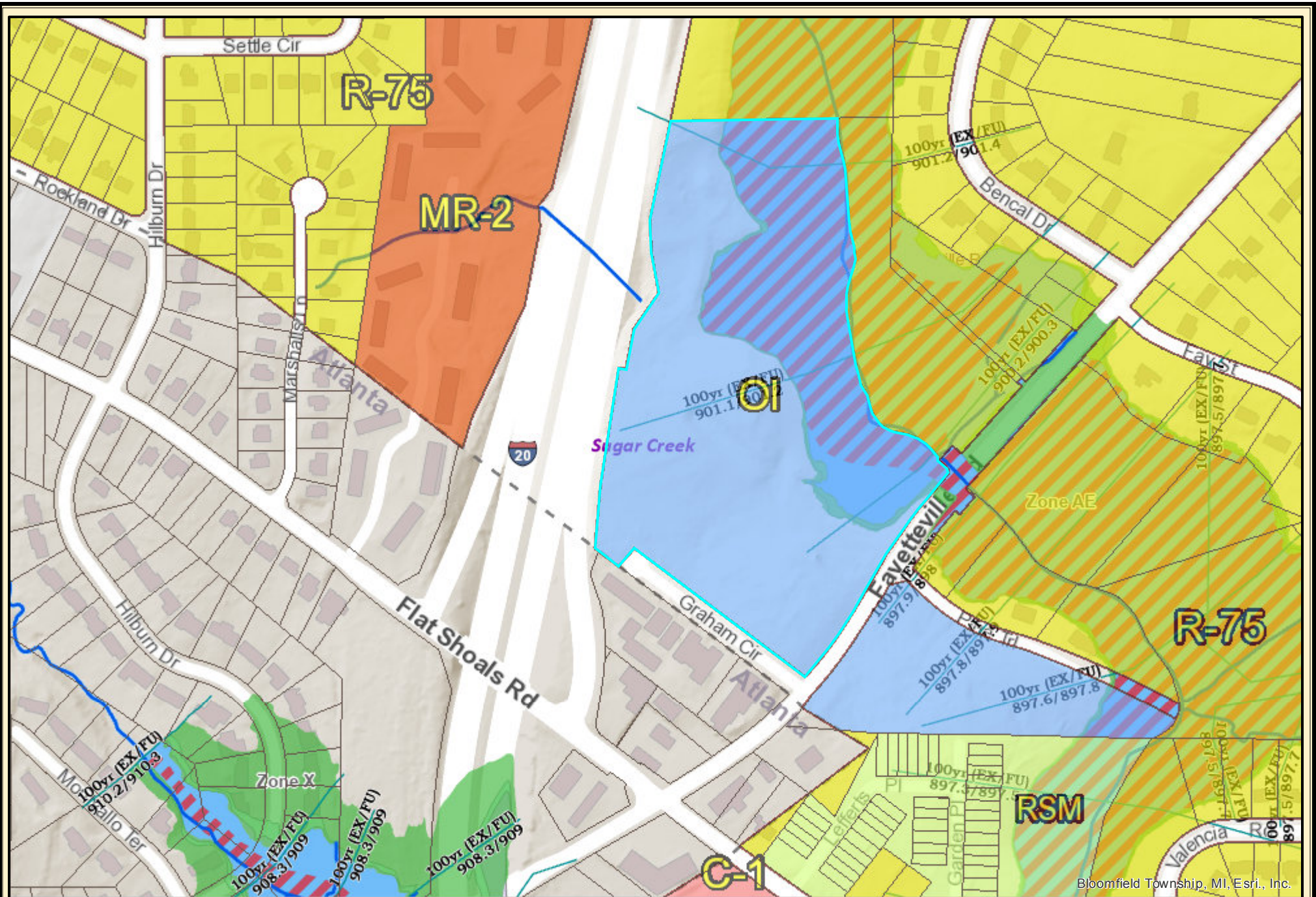

Bloomfield Township, MI, Esri., Inc.



1065 Fayetteville Z Map

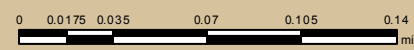

Date Printed: 10/27/2022



DeKalb County GIS Disclaimer

The maps and data, contained on DeKalb County's Geographic Information System (GIS) are subject to constant change. While DeKalb County strives to provide accurate and up-to-date information, the information is provided "as is" without warranty, representation or guarantee of any kind as to the content, sequence, accuracy, timeliness or completeness of any of the database information provided herein. DeKalb County explicitly disclaims all representations and warranties, including, without limitation, the implied warranties of merchantability and fitness for a particular purpose. In no event shall DeKalb County be liable for any special, indirect, or consequential damages whatsoever resulting from loss of use, data, or profits, whether in an action of contract, negligence, or other actions, arising out of or in connection with the use of the maps and/or data herein provided. The maps and data are for illustration purposes only and should not be relied upon for any reason. The maps and data are not suitable for site-specific decision-making nor should it be construed or used as a legal description. The areas depicted by maps and data are approximate, and are not necessarily accurate to surveying or engineering standards.

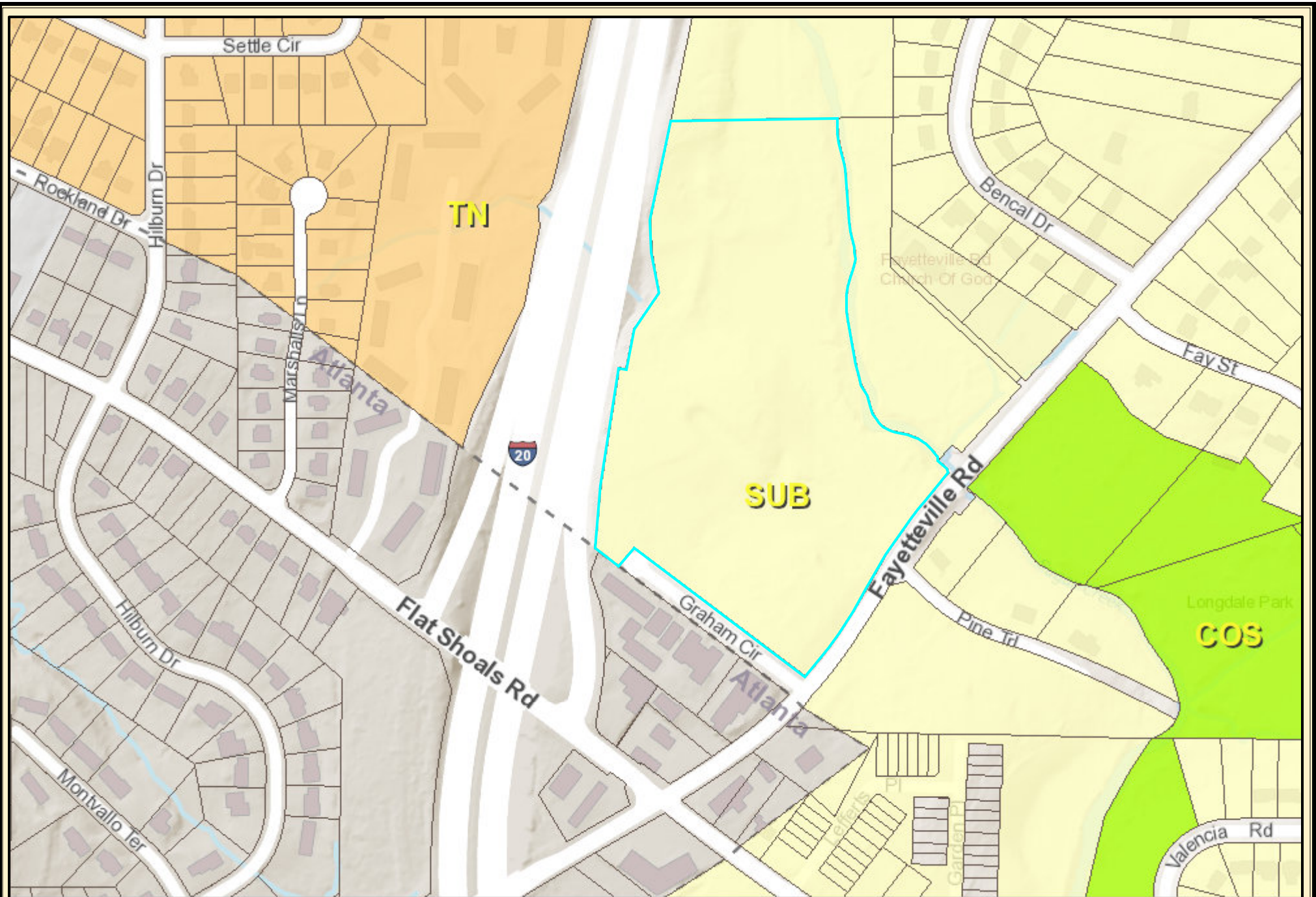

1065 Fayetteville FLU Map

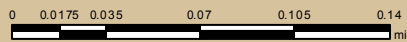

Date Printed: 10/27/2022



DeKalb County GIS Disclaimer

The maps and data, contained on DeKalb County's Geographic Information System (GIS) are subject to constant change. While DeKalb County strives to provide accurate and up-to-date information, the information is provided "as is" without warranty, representation or guarantee of any kind as to the content, sequence, accuracy, timeliness or completeness of any of the database information provided herein. DeKalb County explicitly disclaims all representations and warranties, including, without limitation, the implied warranties of merchantability and fitness for a particular purpose. In no event shall DeKalb County be liable for any special, indirect, or consequential damages whatsoever resulting from loss of use, data, or profits, whether in an action of contract, negligence, or other actions, arising out of or in connection with the use of the maps and/or data herein provided. The maps and data are for illustration purposes only and should not be relied upon for any reason. The maps and data are not suitable for site-specific decision-making nor should it be construed or used as a legal description. The areas depicted by maps and data are approximate, and are not necessarily accurate to surveying or engineering standards.

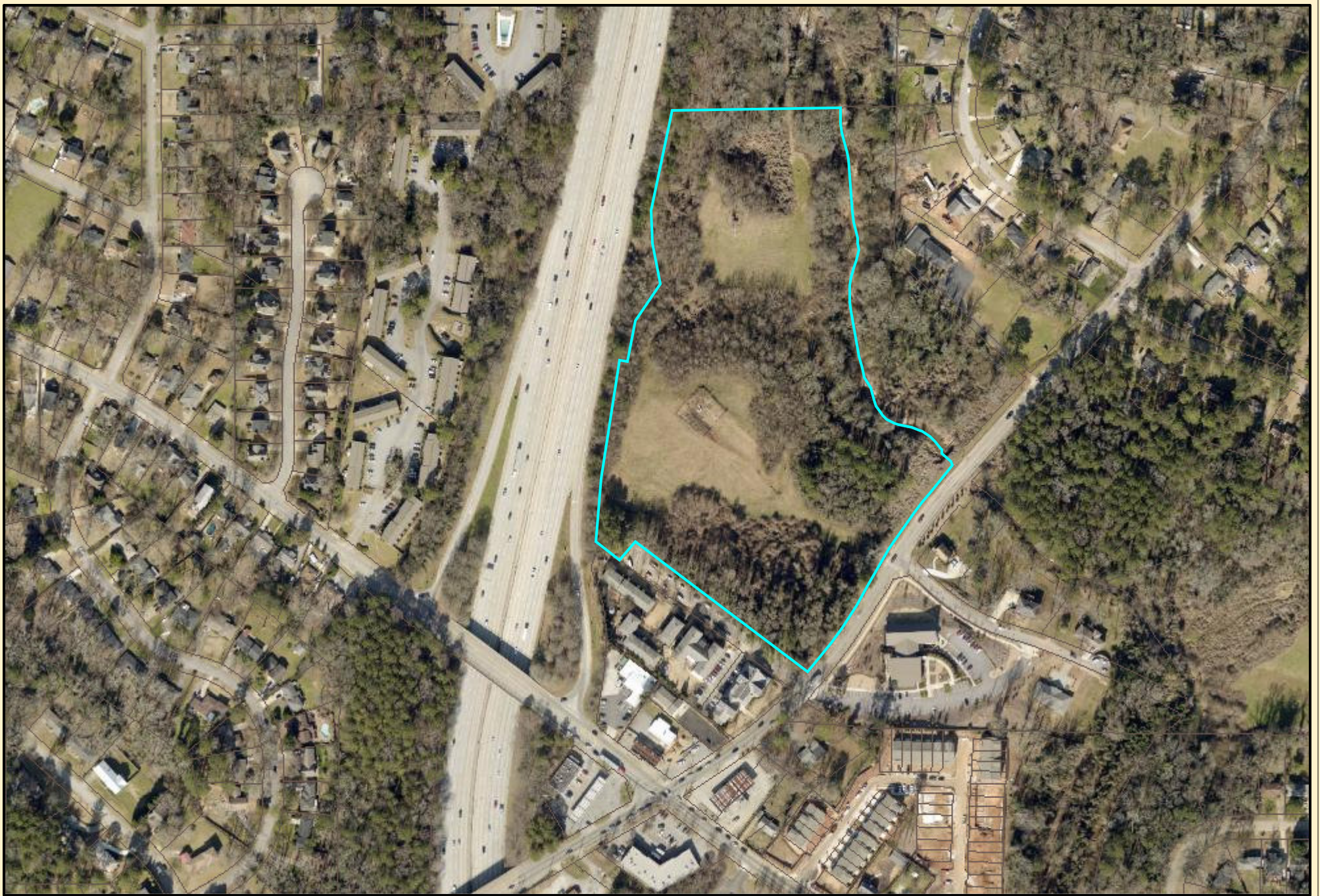

1065 Fayetteville Aerial Map

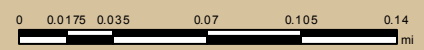

Date Printed: 10/27/2022



DeKalb County GIS Disclaimer

The maps and data, contained on DeKalb County's Geographic Information System (GIS) are subject to constant change. While DeKalb County strives to provide accurate and up-to-date information, the information is provided "as is" without warranty, representation or guarantee of any kind as to the content, sequence, accuracy, timeliness or completeness of any of the database information provided herein. DeKalb County explicitly disclaims all representations and warranties, including, without limitation, the implied warranties of merchantability and fitness for a particular purpose. In no event shall DeKalb County be liable for any special, indirect, or consequential damages whatsoever resulting from loss of use, data, or profits, whether in an action of contract, negligence, or other actions, arising out of or in connection with the use of the maps and/or data herein provided. The maps and data are for illustration purposes only and should not be relied upon for any reason. The maps and data are not suitable for site-specific decision-making nor should it be construed or used as a legal description. The areas depicted by maps and data are approximate, and are not necessarily accurate to surveying or engineering standards.